



WE MANUFACTURE  
**QUALITY**

SINCE **1946**



# 2023

**COLLECTION**

**BUYER'S GUIDE**

[SCUBA DIVING] [FREEDIVING] [SNORKELING]  
[SWIMMING] [SPEARFISHING]

**EN-€**

Cressi was founded, and still lives, just steps from the sea in **Genoa**. We breathe sea air in everything we do, and every one of our products is inspired by the incredible beauty of the waters we see before us.

The only way to fight pollution in the sea is to be aware and active, first hand.

**Cressi decided to take some concrete actions**

01

CRESSI HEADQUARTERS IN GENOA SUPPLIED BY RENEWABLE ENERGY

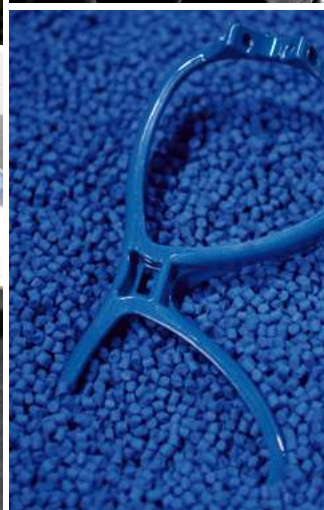

Cressi is proud to announce that its Genoa factory is operating with 100% renewable energy. Alternative and renewable energy sources are crucial for the environmental health of the world's seas and for our future. The only way to fight ocean pollution and to conserve the beauty and health of the planet's oceans is to be aware and proactive. At Cressi, we decided to take action: 100% of the energy used in our Genoa factory is clean and completely green.



02

CRESSI'S PACKAGING



We live by the sea, we work with the sea and we love the sea, so it's our responsibility to give it care and respect. Our goal is to replace all plastic packaging with alternative sustainable solutions following our policy.

“In Cressi we have always focused on sustainability by orienting ourselves to the protection of the environment and especially of our seas. Since 2019 production and offices are powered by renewable energy and today we can proudly say that our establishment is zero impact. We follow the sustainable direction on many fronts, such as in the choice of packaging materials, where we are reducing plastic and replacing it with recycled or recyclable materials. We are also very active in sponsoring events related to cleaning up the seas to ensure that future generations have our same opportunities.”

**Marco Cressi**

# BUYER'S GUIDE

COLLECTION 2022



## CRESSI WHO WE ARE

Join the Cressi Family	6
History	8
Territory	10
Headquarters	11
Net	12



## BUYER'S GUIDE OUR DNA

The collection	14
Ambassadors	16
Partners	21
Warranty policy	22
After sale pricelist	22
Our labels	23



## COMPUTER WATCHES DIVING COMPACT DEVICES

Computer watches	25
Computer w. accessories	30



## COMPUTERS DIVING DEVICES

Computers	33
Computer consoles	37
Computer accessories	39
Comparison table	41



## NEOPRENE ACCESSORIES

Vests	124
Hoods	126
Accessories	127
Boots & Socks	128
Gloves	130



## FINS THE RIGHT THRUST FOR EVERYONE

Scuba fins	133
Gara fins	142
Multi-purpose fins	156



## SNORKEL SETS FINS + MASK + SNORKEL

Snorkel sets	172
Fins spare parts	177



## MASKS DESIGNED FOR BEST VISIBILITY

Masks	180
Optical lenses	204
Masks accessories	205

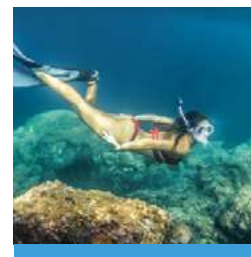

## SNORKELING MASKS QUALITY AND AFFORDABLE MASKS

Adult	207
Junior	216
Masks spare parts	221



## DIVE TORCHES HIGH PERFORMANCE LED LIGHT

Lumia +	291
---------	-----

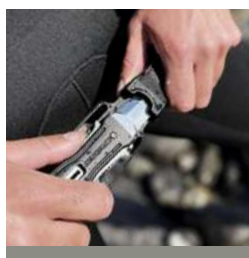

## KNIVES RELIABLE MARINE BLADES

Knives	293
Knives spare parts	300
Knives comparison table	301



## BUOYS FOR DIVING, SWIMMING AND FREEDIVING



## BALLOON & TANKS DIVING ACCESSORIES

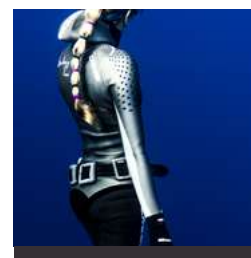

## BELTS FOR WEIGHTS FASTENING

Belts	307
Weights	307



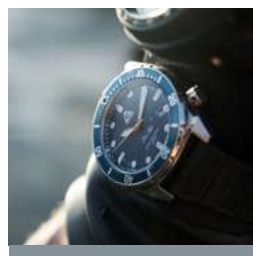

**WATCHES**  
**WATERPROOF TIMEPIECES**

Sea Lion watch 43



**CONSOLES**  
**DIVING PRECISE INSTRUMENTS**

Digital consoles 46  
Analog consoles 48  
Consoles spare parts 50

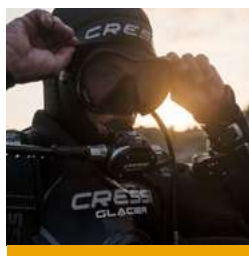

**REGULATORS**  
**HIGH PERFORMANCE STAGES**

Regulators 52  
Octopus regulators 60  
Comparison table 63  
Regulators spare parts 64  
Regulators service & repair 65

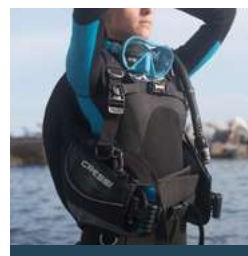

**B.C.D.'S**  
**BUOYANCY CONTROL DEVICES**

B.C.D.'S 67  
Scuba set 83  
B.C.D.'S spare parts 85  
B.C.D.'S comparison table 86



**WETSUITS**  
**FOR DIVING, SWIMMING, SURFACE**

Divesuits 90  
Freediving wetsuits 102  
Wetsuits 103  
Shorty wetsuits 106  
Dive Center suits & rashies 110  
Swimming wetsuits 116  
Wetsuits Size Chart 122



**SNORKELING COMBOS**  
**MASK + SNORKEL**

Adult combo 224  
Junior combo 236



**SNORKELS**  
**COMFY AND SAFE BREATHING**

Adult size 241  
Junior/kid size 249  
Snorkel Spare Parts 251



**SWIMMING GOGGLES**  
**IDEAL FOR SEA SWIMMING**

Adult goggles 253  
Junior/Kid goggles 264

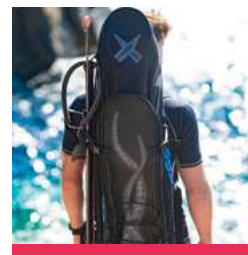

**BAGS & BACKPACKS**  
**EQUIPMENT TRANSPORTING**

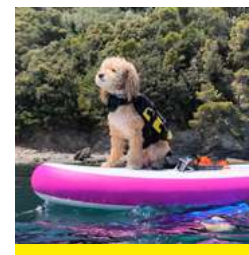

**CRESSI DOG**  
**BRINGS YOUR DOG IN WATER**

Dog Life Jacket 287  
Dog Wetsuit 288

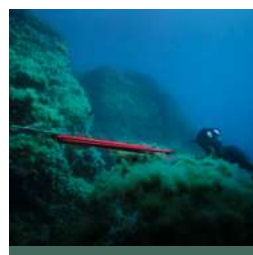

**CRESSI SPEARFISHING**  
**OUR DNA**

The collection 308  
Sustainability 310  
World Championship 311  
Ambassadors 312  
Partners 315



**SPEARGUNS**  
**SLING AND PNEUMATIC SPEARGUNS**

Sling spearguns 317  
Pneumatic spearguns 326  
Spearguns comparison table 328  
Pneumatic Spare Parts 330  
Rubber bands 330  
Gun shafts 332  
Speargun reels 335  
Speargun accessories 336



**WETSUITS**  
**IDEAL FOR SPEARFISHING**

Spearfishing wetsuits 339  
Spearfishing vests 347  
\*Wetsuits Size Charts \*122



**APPAREL**  
**CRESSI SPORTSWEAR**



**BRAND SUPPORT**  
**FOR SHOPS & EVENTS**

Shop display 357  
Banners, flags and stickers 362  
Totems 364  
Dive Center flags 365

/ JOIN THE CRESSI FAMILY

# JOIN THE

# FA



**EGIDIO  
CRESSI**



**NANNI  
CRESSI**





Diving, Snorkeling and Water Sports are not 3%, 5% or 10% of our business. They are 100% of our business. We are focused only on water related sports.

We have been doing this, in the bay of Portofino, since 1946 and **this is what makes Cressi different.**

SINCE 1946

**ANTONIO CRESSI & MARCO CRESSI**



**WE USE & TEST OUR PRODUCTS**

OURSELVES  
OURSELVES  
OURSELVES  
OURSELVES  
OURSELVES  
OURSELVES  
OURSELVES  
OURSELVES



# WE ARE FAMILY

1930

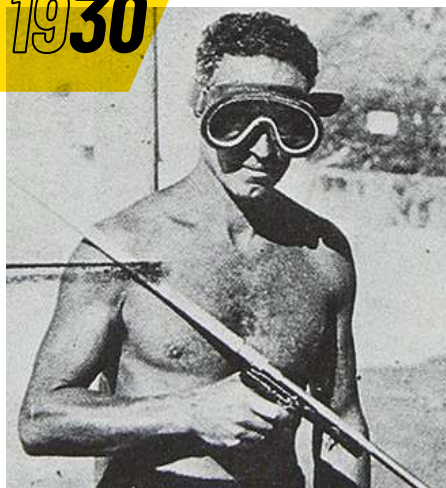

1938

Brothers Egidio and Nanni Cressi start to handcraft the first masks and spearfishing guns. These are the origins of Cressi, the oldest scuba diving equipment company worldwide.

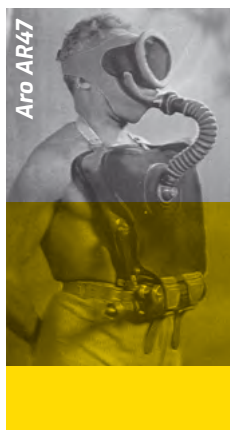

1940



1943

The first Cressi mask, The Sirena, was hand crafted in 1943. It remained in the catalogue, with various updates, for more than 30 years.

1946

The Cressi company is officially founded in Genova, Italy.

1947

In 1947 the first oxygen rebreather was produced; Aro AR47. It was already highly advanced and fitted with sophisticated technical solutions, like the condensation receptacle.



Pinocchio



1950

1952

**Pinocchio Mask, which makes equalization possible. It is a major innovation in the early '50s. It is the most famous and most sold mask in the world's history, and it is still included in the catalogue.**



1953

**Rondine Fins - Also in the field of fins, Cressi invented the model that has inspired all other manufacturers, the first floating model in the world.**

1957

Cressi athlete Mario Catalani wins the first spearfishing World championship and get the gold medal in Jugoslavia.



1965

Cressi opened one of the first workshops that specialized in producing optical masks. Thanks to Cressi, even people with visual defects could now get full enjoyment of the underwater universe.



1970

**Equi-vest - In 1970, Cressi was the first manufacturer in the world to produce Equi-Vest, a futuristic jacket that became one with the scuba tank, supplied by a hose that drew air directly from the first stage. This was the first incarnation of the modern BC.**

1970

**Rondine L long fins - The world leader of molding rubber fins, Cressi developed the Rondine L long fins, which enabled Jacques Mayol to go onto achieve his astonishing freediving records.**

1979

**Fins range - Alongside the various rubber fin models, a futuristic model was presented with a reinforced nylon blade, called the Rondine Gara, a fin that thirty years down the line is still going strong, and has been adopted by world class freedivers and spearfishermen the world over.**







**1980**

**1983**  
Jacques Mayol, the first man in the world to challenge the 100m barrier. He reached a depth of 105 meters. The episode has gone down in history, the record was obtained in the waters of the island of Elba in 1983.

**1988**  
Apache Arbalète - Cressi produced a complete range of Arbalète spearguns to join the pneumatic guns, called the Apache, which very soon became the Champion speargun in the world.

**1989**  
Cressi athlete Renzo Mazzarri wins the spearfishing world title in Italy.



**1990**

**1990**  
Cressi continues its international expansion and the products are by now distributed in over 90 countries world wide.

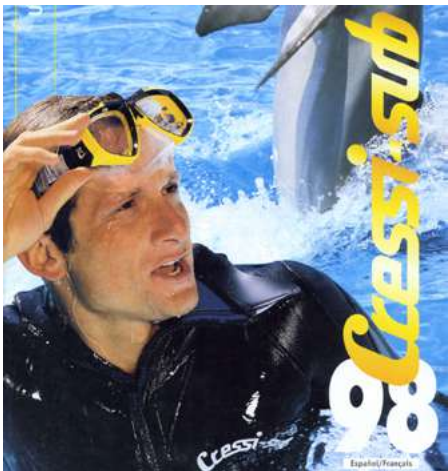

**1999**  
Cressi Athlete Umberto Pelizzari sets the freediving "No Limits Absolute Variable Weight" World Record in Portofino (Italy) reaching the depth of 150 meters.



Big Eyes Evolution

**2000**

**2000**  
Big Eyes was the first mask in the world with raked lenses in an upside-down teardrop shape, an innovative form that gives the diver a complete view of all the equipment worn. They became the most widely copied and imitated mask in the world, a gratifying appreciation of how far ahead Cressi is in the design of its products.



Leonardo

**2010**

**2011**  
The Leonardo dive computer watch is introduced, the first of the products designed in-house by Cressi Elettronica in order to guarantee optimum quality, safety and reliability.

**2013**  
The French freediving champion Guillaume Néry becomes a Cressi product endorser. The Giotto dive computer watch is introduced; it processes the data from repeat multi-day dives and dives with gas mixtures and also benefits from the Cressi RGBM algorithm. The Tracina wetsuit for spearfishing is introduced in a new and exclusive camouflage Dark Digital Specter Pat Cressi.



**2020**

**2021**  
Hydrosports is the result of Cressi's experience, consisting of tradition, innovation and quality, since 1946. With its close relationship to the sea environment, the Cressi team has been able to develop this new collection in response to the direct needs it encountered in practice and through water tests on its products.



**TODAY**

The Cressi company is still entirely owned by the Cressi family, which carries on with the same passion, the work started by brothers Nanni and Egidio Cressi. Its spirit lies in the manufacturing tradition, with a clear preference for the conception and realization of its products in-house, from the initial design through to the smallest details. Cressi focuses on those who love all facets of the aquatic world. The company has never exaggerated with successful products on the market, but has instead always invested in research and development to the benefit of quality and reliability, the evolution of materials.

**OUR NUMBERS**

- 75 YEARS OF EXPERIENCE
- 8 BRANCHES AROUND THE WORLD
- SALES IN 100 COUNTRIES WORLDWIDE
- 100 PATENTS
- 11 TIME SPEARFISHING WORLD CHAMPION
- 7.000 REFERENCES
- UNIQUE STYLE



## LIGURIA. OUR LAND, OUR SEA

It was to fish in the depths of Portofino and San Fruttuoso that, just before the Second World War, a group of friends thought of new equipment. Situated between the French border and Tuscany, Liguria is one of the smallest regions in Italy. The Italian riviera is reflected in the blue Mediterranean Sea, but is also surrounded by mountains that drop sheer into the sea. Vegetation forms the backdrop to some of the country's most popular and well-known seaside resorts.

The coasts are generally high, rocky, jagged, especially in the Riviera di Levante, while in the Ponente there is an almost perfect alternation between sheer cliffs and sandy beaches.

**It couldn't be any other way, the strong passion for the sea finds its place in a unique setting with depths to explore.**



**"THE SEA IN LIGURIA, ESPECIALLY AROUND THE PORTOFINO PROMONTORY, IS EXTRAORDINARILY BEAUTIFUL AND, WHAT'S MORE, ACCESSIBLE WITHOUT TOO MANY PROBLEMS. THIS HAS PLAYED AN IMPORTANT ROLE IN THE BIRTH AND GROWTH OF A DIVING EQUIPMENT CENTRE IN THESE PARTS."**

Antonio Cressi



**" I'M PROUD TO HAVE ALWAYS MANUFACTURED OUR MOST STRATEGIC PRODUCTS AT OUR HEADQUARTERS IN GENOVA, ITALY."**

ANTONIO CRESSI



## THE CRESSI HEADQUARTERS

In 1989, the company was enlarged, moving it to Via Adamoli, along the Bisagno valley in Genoa. And then came the electronics department. Since 2008 we have created a research and development department for this sector and so we produce directly the many control instruments that are now used during diving. With 150 employees and

seven branches, Cressi is a world leader in the production of diving equipment, innovation, and development with exports accounting for 80% of turnover.

**BUT THE ONLY ONE STILL RUN BY A FAMILY**

/ NET

# WHERE WE ARE

WORLDWIDE

Our headquarters is based in Genoa, and we also have eight branches: USA, Mexico, Brazil, France, Spain, China, Thailand and Australia. 70% of our products are made in Italy in our own factory, in Genoa. 10% of our products are made in our own production facility in Hungary and the remaining 20% is sourced from selected high-quality suppliers from Asia.

We have around 10,000 shops all over the world, and our products are sold in over 100 countries.



## CRESSI ITALY HEADQUARTERS

**Cressi Sub S.P.A.**  
Via G. Adamoli, 501  
16165 Genova - Italy  
Tel. +39 010 830 791



1980



## CRESSI FRANCE

**Cressi Sub France**  
Espace La Gaude, 9565 Route De Saint Laurent  
06610 La Gaude - France  
Tel. +33 049 329 0318



1987



## CRESSI U.S.A.

**Cressi Sub U.S.A.**  
3 Rosol Lane, Saddle Brook - NJ 07663 - USA  
Phone: (800) 338 9143  
Phone: (201) 594 1450



2017



## CRESSI MEXICO

**Cressiwater S.A.P.I De C.V.**  
Central de Abastos, Carretera - Cancun-Aeropuerto km 17, Cancun  
Quintana Roo. C.P.77565 - Mexico, VAT NO.CRE161110812  
Phone: +52 1 554 162-2052



2018



## CRESSI THAILAND

**Cressi South East Asia Ltd**  
135/6-7 Moo 4 - Patak Road, Tambon Rawai  
Amphur Mueang, Phuket - Thailand 83130  
Mobile: +66 (0) 643971234



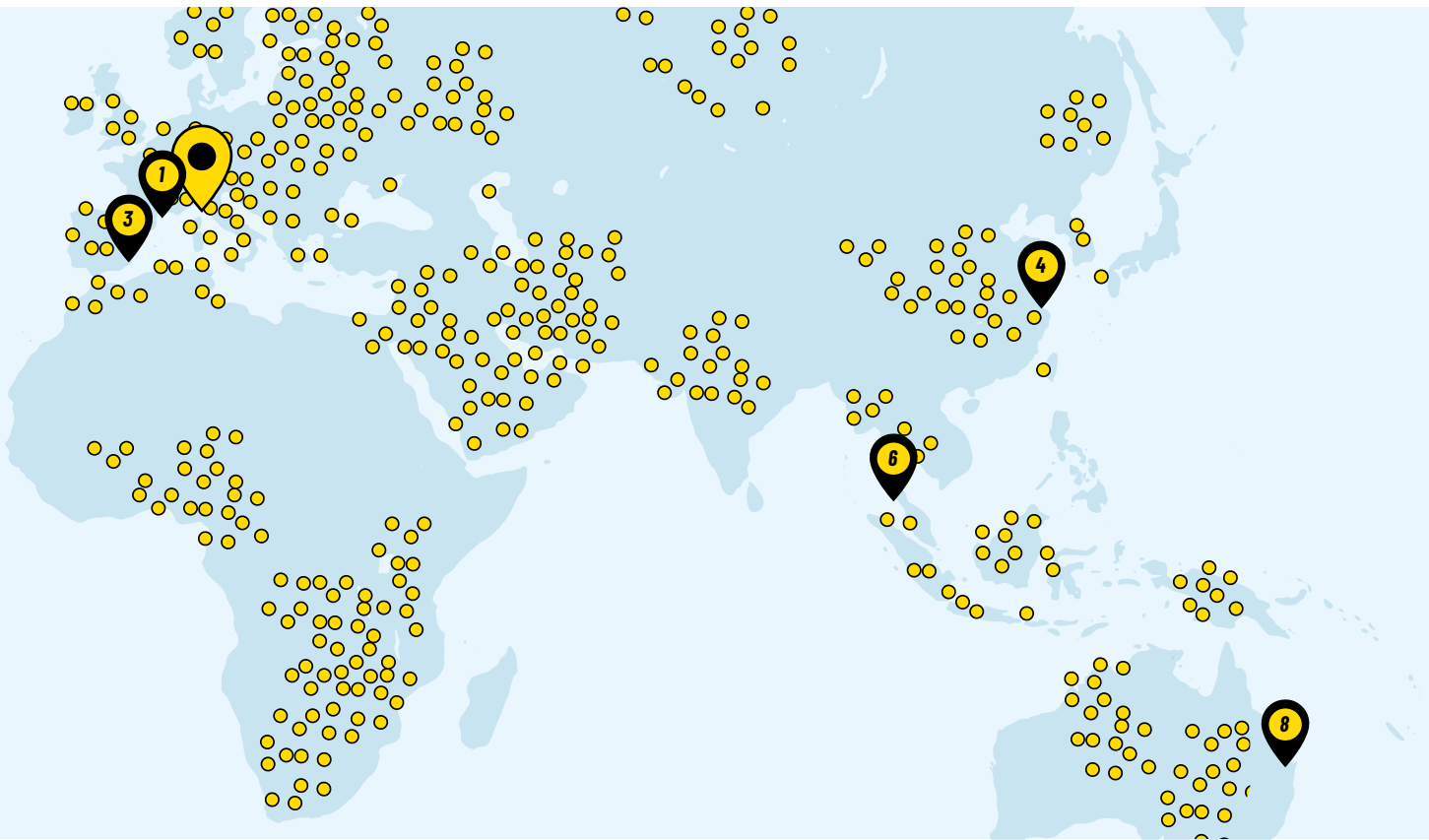

3

**CRESSI ESPAÑA**

*Cressi-Sub España S.A.*  
 NIF: A60130978 - C/Castellassa, 24 Nave 3, Poligono Can Petit 08227  
 Terrassa Barcelona - Spain  
 Tel. +34 937 841 888



4

**CRESSI CHINA**

*Cressi China Watersports Products Co.,Ltd*  
 No.4 Zhuhai Road  
 Kunshan City - Jiangsu province, China  
 Phone +86 512-3668 0846



7

**CRESSI BRASIL**

*Cressi Brasil COM. MAT. ESP. LTDA*  
 Avenida Padre Anchieta, 175 - Jordanópolis, São Bernardo do Campo  
 SP, 09891-420  
 CNPJ: 35.112.958/0001-59



8

**CRESSI AUSTRALIA**

*Cressi Australia*  
 64 Edison Crescent, Baringa  
 Queensland Australia, 4551  
 marketing@cressi.com.au

## CRESSI BUYER'S GUIDE 2023 COLLECTION

Cressi's legacy of innovation began in 1939 with two brothers who shared a passion for the sea and a gift for technical design and working with their hands. Egidio and Nanni Cressi began by crafting masks and spearguns that would allow them to move and hunt more efficiently in the waters near their home. By 1946 their designs and products had become so popular they founded the Cressi company in Genoa, Italy. Today, although Cressi is a worldwide leader in water sports manufacturing, it is still wholly owned by the Cressi family, and the commitment to innovation is still in the company's DNA. It has a long history of groundbreaking product development, and has often been the first to bring product advancements to the market.

This history of innovation is also made possible by a commitment to manufacture products in Italy at the Cressi facility. An investment in the latest manufacturing equipment and more than 16,000 square meters of roofed space, and the ability to have the designing and manufacturing process happen side by side has led to the absolute highest standards for quality. It also allows Cressi engineers to quickly develop, test and incorporate the latest materials and technologies.

Innovations continue, the results today are the same as they were in the beginning, the most advanced and best made products in the world.

**Cressi's experience and the Italian know-how gives life to the new 2023 collection.**

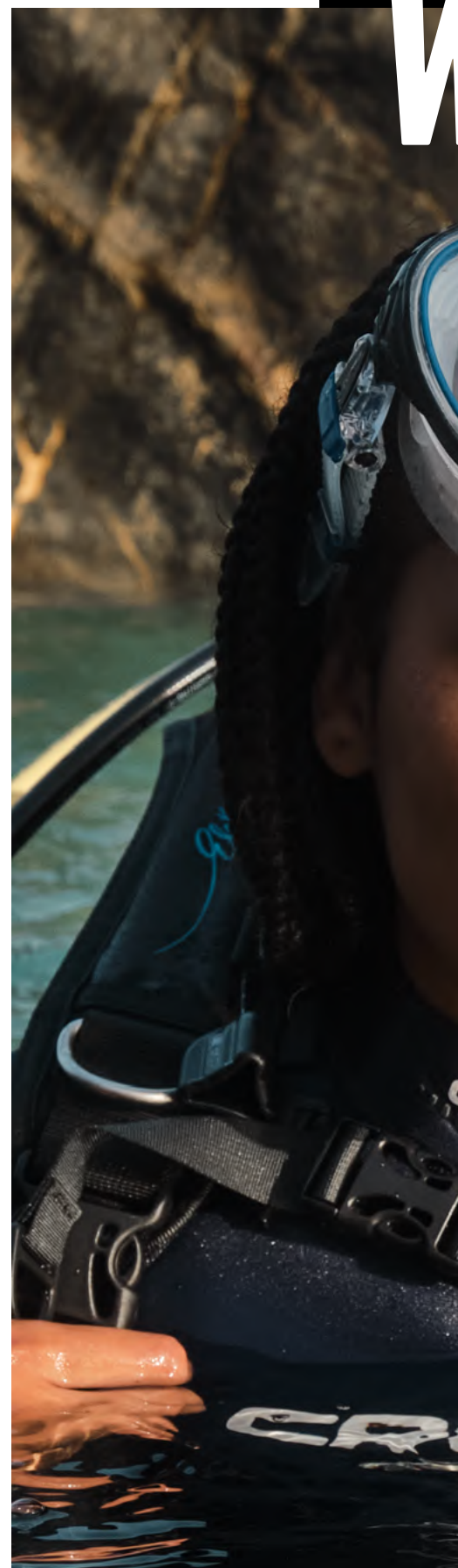



# WE MANUFACTURE QUALITY SINCE 1946





# GUILLAUME NÉRY

OUR

**Guillaume Néry** grew up in Nice, France, by the Mediterranean Sea, and discovered freediving when he was 14 years old. At 15, he joined a freediving club, where he began to specialize in the constant weight discipline (wearing fins and without the use of a sled). At 19 years old, he joined the French national team and set a French constant weight national record of 82 meters (which also matched the world record at the time). The following year, he reached 87 meters in constant weight, becoming the youngest world record holder in the history of freediving. In 2004, Guillaume travelled to Reunion Island, where he set another world record of 96 meters. In 2005, while training for the first freediving world championships organized in Nice, Guillaume reached 100 meters during a training session. The same year, he reached 105 meters, which was Jacques Mayol's last world record, set in 1983 in the No Limits discipline (going down with a sled, and coming up with a balloon filled with air). In 2006, he reached 109 meters. In July 2008, he broke the constant weight world record for the fourth time (113 meters). Two months later, with the French freediving team (with Morgan Bourc'his and Christian Maldamé) he became Team World Champion in Egypt. It was the first gold medal for the French Team in a freediving world championship. In 2011, Guillaume won the constant weight AIDA freediving World Champion title, in Kalamata, Greece, with a dive to 117 meters.

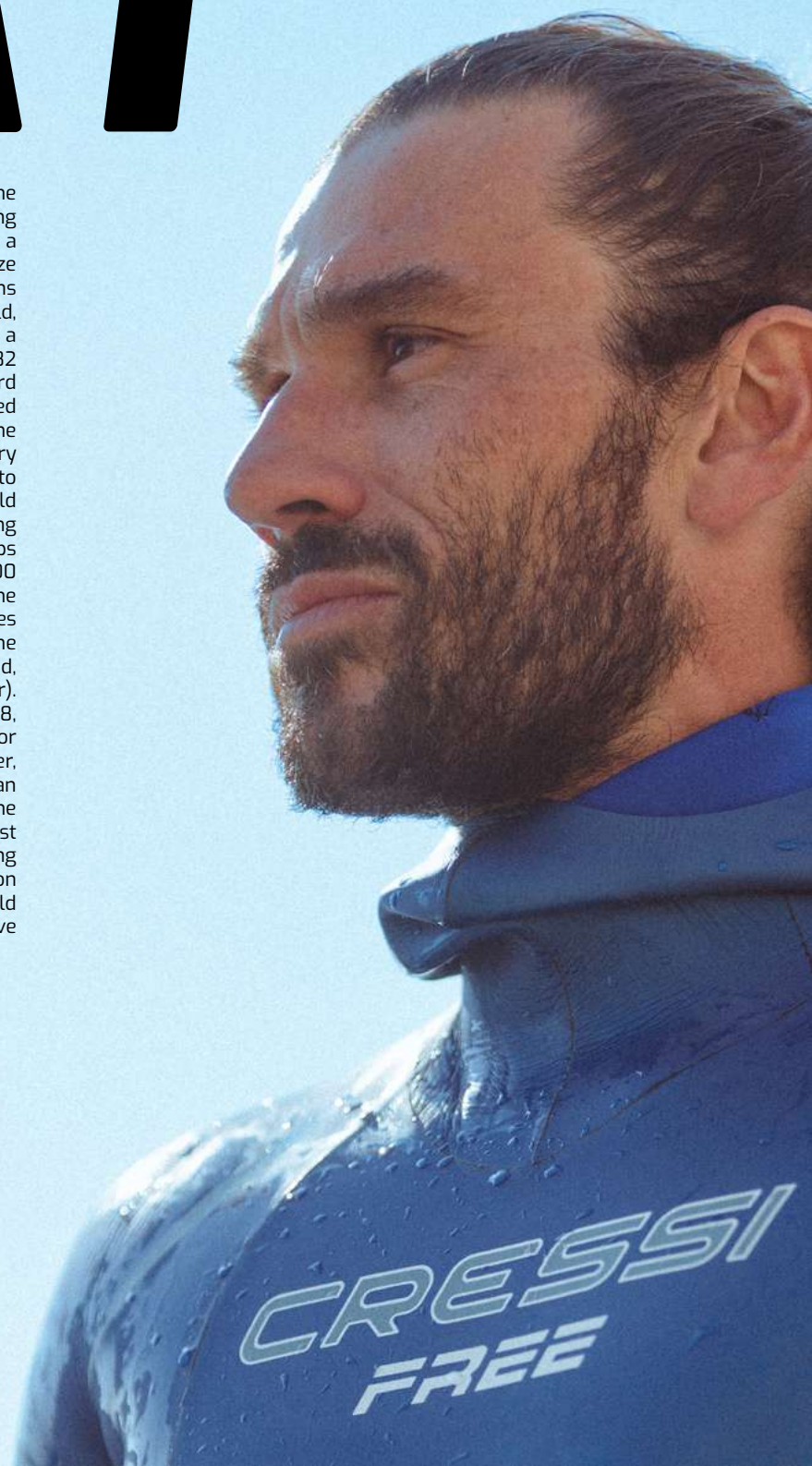



# AMBASSADORS



## HOW I STARTED FREEDIVING

The first real contact with breath-hold was at the age of 14, and it was not even in the water. I was with a friend in the bus between school and home, and we were playing a game: Who can hold his breath the longest. I lost. So I started to challenge myself at home, in my bed. I discovered after few weeks I was able to hold my breath more than 4 minutes. The feeling of exploring the limits of my body was very exciting. Then I decided to try it underwater, to discover the unknown territory of the deep water. I just fell in love with this amazing feeling to explore the unknown. A few months later I discovered that I could train properly with the only freediving club at that time, which by chance was located in Nice. It was October 1997. I was 15, and the real adventure with freediving was just starting.

## WHAT IT MEANS TO BE A CRESSI OCEAN AMBASSADOR

Before being named a Cressi Ambassador, I was buying Cressi gear. I remember my first pair of fins was the Gara 2000. I remember having always dived with a Superocchio mask when I was younger. So to me, Cressi equipment has always been super top quality. On top of that, Cressi has supported the two legends of freediving history: Jacques Mayol and Umberto Pelizzari. So when I was asked to become a Cressi Ambassador, it was a huge honor. I hope we will continue this adventure together for a while!

 Guillaume Néry

 guillaumenery



YouTube  
Guillaume Néry  
Youtube Channel

/ OUR AMBASSADORS

**ASIA BRYNNE**

Hawaii 



 **asiabrynne**

I picked up my first disposable film camera at the age of 8 and never stopped shooting. The ocean is a place away from all of the noise, where you don't have to use words, time doesn't exist, and you can share space with animals. Being underwater is a break from the busyness of life.

**THE BUCKET LIST FAMILY**

worldwide



 **thebucketlistfamily**

The Gee family, just a typical family working from all over the world as Family Travel Journalists! Their story began in 2015, when they decided to sell everything and leave home for a trip around the world. They started an Instagram and YouTube channel called, The Bucket List Family.

**DANILO CALLEGARI**

Italy 



 **callegaridani**

He explored the most inhospitable places in the world, swam in the oceans and climbed the highest mountains, he crossed entire continents by bicycle... then four deserts and the largest glacier in Europe. His mission is to fuse air, land and water into a single adventure.

**GIADA CAMPANELLA**

Italy 



 **giadacampanella**

I am a dynamic yoga teacher, yoga for me is a connection to nature. In the water we are put to the test and we can only abandon ourselves to the water that envelops you and hugs you gently. When I dive underwater my mind is canceled, the body is abandoned and there are no other sounds other than that of your heart, then my mind calms down.

**FABIO ROLLERI**

Italy 



 **fabioroller**

Breathe is a project that aims to raise awareness of the beauty of underwater nature. We were born in contact with the sea and water has always been part of us. Below the water level everything stops, it's just you, your heartbeat and your room! Calm rules everything around you and it is at that point that you realize how wonderful there is underwater.

**IGOR D'INDIA**

Italy 



 **igordindia**

Igor has been able to combine his passion for outdoor adventure with his training in underwater filmmaking, camera drone pilot operation and advanced open water diving. He is deeply committed to participating in the global community who are fighting to protect the ocean.

**REGINA DOMINGO**

Mexico 



 **regisunday**

Regina is part of the Nakawe project. The mission is to promote the conservation of critical ecosystems and species by working directly with communities to promote sustainable solutions to local environmental issues and educate local populations on the importance of biodiversity.

**KRYSTAL DORN**

USA 



 **krystalklear**

Krystal moved to Hawaii, when she began photographing underwater and free diving. She is well known for capturing artistic images underwater, from mermaid photography to conservation awareness projects. Her mission is to help raise awareness for animal species.

**GIULIA GABBRIELLESCHI**

Italy 



 **gabbri1996**

Giulia Gabbrielleschi is an Italian swimmer, specialising in open water swimming. At the World Championships, she won a silver medal (Gwangju 2019) and a bronze medal (Budapest 2017) in the 5 km team event. The challenges continue and year after year she brings home excellent results.

**CHRISTOPHER GILLETTE**

USA 



 **gatorboys\_chris**

I'm born in Florida and have spent my life around the water. I love the freedom, weightlessness, and otherworldly views of diving. I try to use my passion to teach others about aquatic wildlife in the hopes they will learn to love them too, and ultimately help protect these fragile ecosystems.

**KAYLEIGH & CAMERON GRANT**

Hawaii 



 **mermaid.kayleigh**

Kayleigh and Cameron are passionate divers who strive to educate and encourage people to protect our oceans. As a marine conservationist, Kayleigh understands the importance of educating people about ocean conservation. Through her work at One Ocean Diving, she's able to inspire people's in protecting the world's sharks and marine life.

**PHILIP HAMILTON**

UK 



 **philip.hamilton.photography**

Philip Hamilton, filmmaker, photographer and author, is best known for his passion and dedication to ocean conservation. He has over thirty years diving and sailing experience and has documented most marine animals on the planet, from the majestic Blue whale to the smallest underwater critters.



OUR AMBASSADORS

**THEO KNEVEL**

Netherlands



[theo\\_knevel](#)

Theo is a scuba diving and advanced free diving instructor. He joined Cressi following a 10-plus-year career as a frogman in the Special Boat Service. He has been able to spread his passion for diving throughout the Caribbean. He is co-founder and chairman of the War Veterans Foundation.

**BROOKS LAICH**

USA



[brookslaich](#)

He's a Canadian former professional ice hockey forward. He played over 750 National Hockey League games. Brooks is a multi-athlete and a sports lover, so what better way to kick off the day? A little snorkel session when the water is calm and fishes and turtles are active.

**SHAWN MAHONEY**

USA



[thebeaconscollective](#)

All of my first gear was Cressi, and most of it since has been. The early pioneers of freediving wore Cressi and I saw how successful they were so I said why not emulate what they do? I loved and still do my Cressi Gara 2000's. That's why it was a no brainer to say yea to being a Cressi ambassador.

**FRANCESCO MAGISTRALI**

Italy



[beyond.exploration](#)

Francesco is the creator of the Beyond Exploration brand. His family, his friends and his collaborators are all part of this team. In the name of Beyond Exploration's mission itself. Francesco's gaze is always turned towards the future. Adventure, travel and exploration are the means to deeply know the world, the Mystery and Humanity.

**LLUIS MASUET**

Spain



[masuleti\\_underwater](#)

In 2016, tired of the business world, he tried scuba diving and began to learn underwater photography, a combination that in just a few short years made this Barcelona citizen a renowned, award-winning photographer. Lluís currently travels all over the world capturing beautiful images.

**LEO MORALES**

Mexico



[leomoralesbuzo](#)

For many, scuba diving is an adventurous, recreational activity. For Cressi ambassador Leo Morales, scuba diving was therapy and the pathway to a second chance at life. After surviving a rare form of cancer, it was scuba diving that helped Leo to heal and find a deeper meaning into the purpose of his life.

**ROBERTO OCHOA**

Ecuador

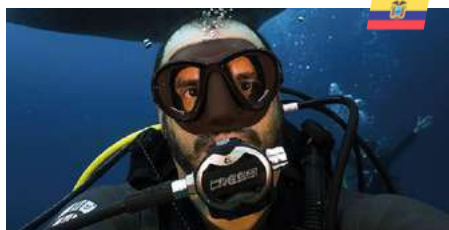

[robertoochoahe](#)

Roberto Ochoa is a Videographer for Planeta Azul, he started making wildlife videos at the age of 25 in the Galapagos Islands, Africa and North America. Beneath the world's waters lie landscapes, species, vegetation, and populations as diverse and splendid as those on land.

**OCEAN RAMSEY & J. OLIPHANT**

Hawaii



[oceanramsey](#)

"Mr. and Mrs. Sharks." She is a marine biologist, shark and marine conservationist, professional freediver and scuba instructor, surfer, swimmer and professional model. Juan grew up surfing, he became a divemaster. He traveled the world with to help combat illegal fishing and whaling.

**CRAIG O'CONNELL**

USA



[thesharkdoctor](#)

I'm from a small town located several hours from the ocean. But I always had a fascination with the ocean, a fascination that really came to fruition during my first shark encounter in the Florida Keys when I was 14. My free diving and scuba career began and has been growing ever since.

**NATALIE PARRA**

USA



[nataliekparra](#)

I'm from Southern California. I grew up playing in the ocean, but it wasn't until I was visiting the island of Oahu prior to moving there that I tried freediving for the first time. It felt like flying and I couldn't get enough of it. I started researching, taking courses and learning from fellow free divers.

**CRAIG PARRY**

USA



[craigparryphotography](#)

It was his parent's gift of a disposable water proof camera that set him on the path to his passion. While most kids were reading comics, Craig was immersing himself in early editions of Australian Geographic. Finally the 35mm SLR set the course for Craig's future.

**STEVEN PAYNE**

USA



[sevenpayne](#)

Steven grew up surrounded by open spaces, farms, and lakes; he loved exploring and seeing animals. His family moved to Florida, which cemented his love for the ocean. Steven is currently in the process of deploying artificial reefs: His nonprofit, The Reef Genesis Corporation, is his passion.

/ OUR AMBASSADORS

**PIRRY**

Colombia



**pirryofficial**

Pirry is a Colombian journalist, writer, photographer, documentalist and important influencer that is dedicated good part of his journalist work talking about the Ocean and denouncing problems such as illegal fishing, pollution and many other difficulties facing the seas.

**PRO RECCO WATERPOLO 1913**

Italy



**prorecco**

Pro Recco Waterpolo 1913 is a water polo club from Recco and is to this day the most successful team in the world. The sea as an indissoluble link in the history, the symbiotic relationship with Liguria, the sacrifice and the constant search for innovation to win the daily challenges.

**ANDREW RAAK**

USA



**raakbottomimaging**

Passionate about all aspects of the marine environment, Andrew has worked as a dive professional for more than a decade. He has a degree in Marine Science, a captain's license and dive instructor certification. He has traveled the world photographing in amazing locations.

**MARIO RIGBY**

Turks&Caicos



**mariorigby**

In 2018, Mario completed his crossing Africa journey, a two-year trek walking and kayaking from Cape Town to Cairo. This expedition allowed him to connect with communities and share their message and stories. His goal was to inspire people globally to get out, be brave, and see the world.

**ARIANNA ROMERI**

Italy



**ariannaromeri\_art**

I grew up surrounded by equipment and the perfume of neoprene, watching my dad dive and waiting for my moment. I signed up for a freediving course. It wasn't love at first sight; I learned to appreciate it when it became the key to getting to know myself, through its timing, calmness and sensitivity.

**CHIARA SALOMONI**

Italy



**chiaraphoto**

I remember snorkeling all over the Mediterranean Sea, using my father's Cressi fins, which were oversized for my feet. I got into scuba and moved to the U.S. to follow my dream of becoming an underwater photographer, so that I would have the chance to be in the water as much as possible.

**JACINTA SHACKLETON**

Australia



**jacintashackleton**

Jacinta Shackleton is a marine biologist and educator at Lady Elliot Island, located right on the Great Barrier Reef. You might recognize her name from her stunning work filming and photographing marine animals. Most notably, she is 1/50 people to have seen and filmed an Ornate Eagle Ray.

**JONATHAN SCHUTTE**

Cayman islands



**jonschutte**

For as long as I can remember I have had a passion for traveling and telling stories. I love to create content and share my adventures. Through my project Nauti Nomad I hope to inspire you too to embrace life and pursue your passions, respect our planet and help each other!

**SULUBAAI FOUNDATION**

Philippines



**sulubaaifoundation**

Our approach consists in developing our objectives and making our site a model of sustainable management and a leader in ecosystem restoration. We believe that ecosystem preservation requires the involvement of local communities, and that the active management of marine protected areas is necessary to achieve results to deal with existing issues.

**LUCA TIXI**

Italy



**outdoorportofino**

I was born and raised in Recco, at the time of high school, in a period of environmental militancy, the enlightenment arrives: I understand that my job will be to bring people into nature! After graduating in Marine Environmental Sciences at the University of Genoa, I founded Outdoor Portofino.

**FEDERICO TRAVERSO**

Italy



**skullphoto\_aka\_surfskull**

He is a young Italian designer and collaborates with Cressi for many years. Federico is passionate about the sea in all its forms, practice surfing and freediving but instead of hunting, he prefers to take pictures and videos. He starts each day with a morning swim session in the sea.

**NANJA VAN DEN BROEK**

Netherlands



**nanjafreediver**

Nanja van den Broek started freediving in 2001 and in her first competition she immediately set two national records. In 2015, she set a new world record in the discipline Variable Weight with a dive to -130 meters, this record is also her 30th national record.



/ OUR AMBASSADORS

**VOYAGES OF AGAPE**

USA



**voyagesofagape**

Agapé is a 1984 Tayana Vancouver 42', hull #93. "Agapé" means unconditional love. She is a true blue water cruiser, and has already seen much of Mexico, the South Pacific, and beyond. For us Agapé is home. She is a safe and trustworthy vessel that will ferry us to the less seen places of the world.

**JASON WASHINGTON**

Cayman islands



**caymanjason**

For the past two decades, Jason has been a leader in the Cayman Islands water sports community. A 2017 International Scuba Diving Hall of Fame honoree, Jason's focus both locally and abroad has been on protecting the delicate marine life found in the waters of the C. Islands.

**CHRISTINE WEST & ADAM MAIRE**

Hawaii



**christine\_regent\_west**

After working as scuba instructors, adding cold-water diving was the greatest modification to their portfolio. Working together diving on a project in Alaska opened their eyes wide to documenting undersea life in extraordinarily different environments from the warm waters where they began.



**CRESSI, EQUIPMENT PARTNER OF Y-40®**

**CRESSI**  
SINCE 1946



In March 2019 Cressi officially became the partner of **Y-40® The Deep Joy**, the deepest pool in Europe. From that moment on, the recreational diving and freediving equipment available at Y-40® is provided by Cressi.

Y-40® The Deep Joy is the place where everything is possible, where you can live the most amazing aquatic experiences.

4,300 cubic meters of thermal water where there are free diving and scuba diving courses. It's a safe environment for professional exercises and scientific research, in addition to being an amazing film set and area for photographic and advertising services. Y-40® has an area of 21x18m; the maximum depth is 42.15 meters with different platforms at intermediate depths and caves for technical activities.

The deep pool can be visited, it is possible to walk in the transparent tunnel that crosses the structure, discovering the magic of this big human aquarium.



**y40\_thedeepjoy**

## INTERNATIONAL WARRANTY POLICY

In accordance with Directive 1999/44 EC, Cressi guarantees its products against inherent and operating defects. To offer better service to its customers and consumers, and to affirm the efficiency and quality of its manufacturing processes, it has decided to extend the terms of the guarantee as follows:

### DIVE COMPUTERS

Two (2) years from the date of purchase (for rental or teaching use: 12 months for operating defects and 24 months for inherent defects).

Exceptions: Flooding caused by incorrect battery installation, LCD display in the case of damage due to negligence or blows, damage due to leaks of substances from the battery (the guarantee is valid if the computer is new and has not been used), damage caused by dead or non-functioning batteries, damage due to negligence, blows, or to normal wear and tear.

### ANALOG DEVICES

Two (2) years from the date of purchase (for rental or teaching use: 12 months for operating defects and 24 months for inherent defects).

Exceptions: Damage due to negligence, blows, or normal wear and tear.

### REGULATORS

Two (2) years from the date of purchase (for rental or teaching use: 12 months for operating defects and 24 months for inherent defects).

Exceptions: Consumable parts, damage due to negligence, blows, or normal wear and tear.

### B.C.d.'S

Two (2) years from the date of purchase (for rental or teaching use: 12 months for operating defects and 24 months for inherent defects).

Exceptions: Consumable parts, damage due to scratches, punctures, abrasions, or chemical products (including chlorine), all damage due to exposure to the sun, damage due to negligence, blows, or normal wear and tear.

### DRY SUITS

Two (2) years from the date of purchase (for rental or teaching use: 6 months for operating defects and 24 months for inherent defects).

Exceptions: Consumable parts, damage due to scratches, punctures, abrasions, or chemical products (including chlorine), all damage due to exposure to the sun, damage due to negligence, improper use, blows, or normal wear and tear.

### MASKS, FINS, MOUTHPIECES, GOGGLES

Two (2) years from the date of purchase (for rental or teaching use: 12 months for good operations and 24 months for defects of conformity).

Exceptions: Alterations in the color of the silicone, all damage due to exposure to the sun or the effect of chemical or environmental agents, damage due to negligence, improper use, blows, or normal wear and tear.

### SPEARGUNS, KNIVES, BAGS, WETSUITS, BOOTS, GLOVES, AND ALL REMAINING PRODUCTS AND CONSUMABLE PARTS

Two (2) years from the date of purchase (24 months for inherent flaws).

Exceptions: Damage due to scratches, punctures, abrasions, or chemical products (including chlorine), all damage due to exposure to the sun, damage due to negligence, blows, or normal wear and tear.

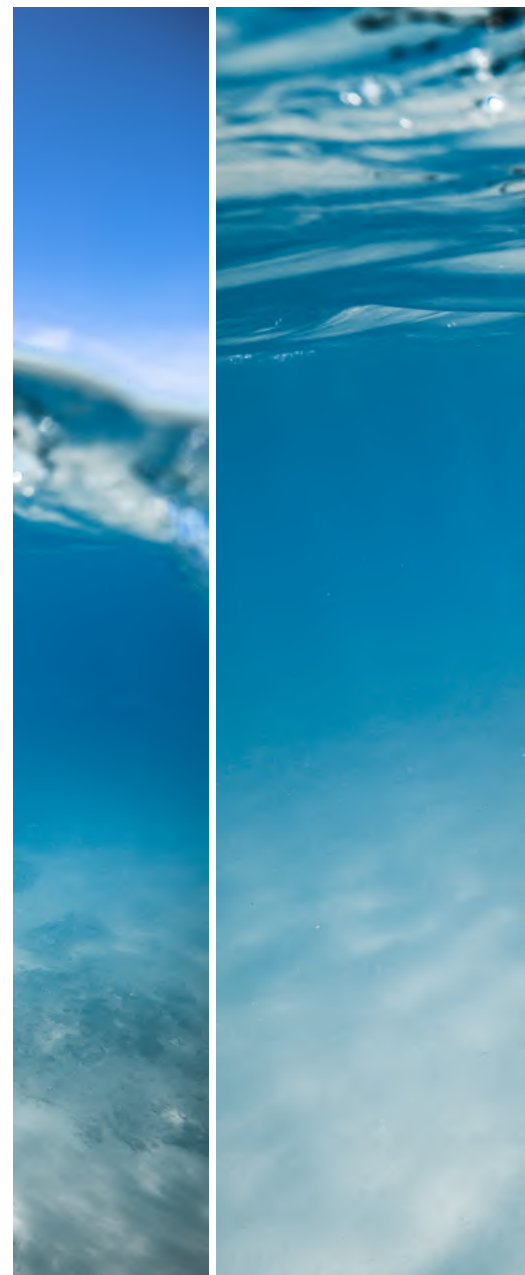

## 2023 TERMS AND CONDITIONS

SHIPPING FROM: CRESSI GENOVA

ORDER AMOUNT	EUROPEAN COUNTRIES	OTHER COUNTRIES
0 € - 249 €	29,99 € HANDLING AND SHIPPING CONTRIBUTION	ORDER NOT ACCEPTED
250 € - 499 €	<b>ZONE 1:</b> 19,99 € SHIPPING CONTRIBUTION <b>ZONE 2:</b> 29,99 € SHIPPING CONTRIBUTION	ORDER NOT ACCEPTED
> 500 €	FREE SHIPPING	ORDER NOT ACCEPTED
> 3.000 €	FREE SHIPPING	ORDER ACCEPTED

ZONE	EUROPEAN COUNTRIES
ZONE 1	Austria - Belgium - Switzerland - Czech Republic - Germany - Denmark - France - UK (£) - Greece - Hungary - Ireland - Italy - Luxembourg - Netherlands - Poland - Slovakia
ZONE 2	Albania - Bulgaria - Cyprus - Estonia - Finland - Croatia - Lithuania - Latvia - Malta - Norway - Portugal - Romania - Sweden - Slovenia

## AFTER SALE PRICELIST CRESSI 2023

PRODUCT CATEGORY / SERVICE	PRICE (EXCLUDING VAT)
BATTERY CHANGE WATCH/COMPUTER	60.00
GLASS WATCH REPLACEMENT	80.00
BUTTONS WATCH REPLACEMENT	80.00
WATCH/COMPUTER STRAP REPLACEMENT	20.00
REGULATORS MAINTENANCE (1 <sup>ST</sup> stage + 2 <sup>ND</sup> stage)	65.00
COMPLETE REGULATORS MAINTENANCE (1 <sup>ST</sup> stage + 2 <sup>ND</sup> stage + octopus)	85.00
BCD MAINTENANCE	70.00
ZIPPER REPLACEMENT DRY SUIT	120.00
ZIPPER REPLACEMENT SEMI-DRY SUIT	90.00
CUF/ANKLE/COLLAR REPLACEMENT SUIT	30.00
OLEOPNEUMATIC GUN MAINTENANCE	40.00





Photo by: Kayleigh Burns & Cam Grant



This product can only be sold offline, it is not allowed to sell it online.

**COMPUTER WATCHES/COMPUTERS**

CARTESIO WATCH COMPUTER  
MICHELANGELO DIVING COMPUTER

**REGULATORS**

T10-SC CROMO/GALAXY R REGULATOR (DIN/INT)

**B.C.D'S**

COMMANDER EVOLUTION B.C.'D  
CARBON B.C.'D

**NEOPRENE SUITS**

COMFORT MAN MONOPIECE WETSUIT 7mm  
COMFORT LADY MONOPIECE WETSUIT 7mm  
COMFORT MAN MONOPIECE WETSUIT 5mm  
COMFORT LADY MONOPIECE WETSUIT 5mm

**MASKS**

ZEUS MASK

**BAGS & BACKPACKS**

JUMBO TROLLEY BAG



The toughest and most reliable products specifically engineered for rental in the hardest conditions of use.

**CONSOLES**

DIGI2 DIGITAL CONSOLE RED

**B.C.D'S**

PATROL B.C.'D  
QUARTZ B.C.'D DIVE CENTER EDITION  
SOLID B.C.'D DIVE CENTER EDITION

**SCUBA SET**

SOLID SCUBA SET (DIN/INT) **NEW 2023**

**NEOPRENE SUITS**

DIVER MAN MONOPIECE WETSUIT 5/7mm  
DIVER LADY MONOPIECE WETSUIT 5/7mm  
DIVER JR MONOPIECE WETSUIT 5mm  
ENDURANCE MAN MONOPIECE WETSUIT 5mm  
ENDURANCE LADY MONOPIECE WETSUIT 5mm  
ENDURANCE MAN SHORTY WETSUIT 3mm  
ENDURANCE LADY SHORTY WETSUIT 3mm

**RASH GUARDS**

DIVE CENTER MAN RASH GUARD LONG/SL  
DIVE CENTER LADY RASH GUARD LONG/SL  
DIVE CENTER MAN RASH GUARD SHORT/SL  
DIVE CENTER LADY RASH GUARD SHORT/SL

**FINS**

FROG FINS  
FREEFROG FINS  
MAUI SAF FINS DIV-CEN

**MASKS**

MATRIX MASK  
SIRENA MASK



A hi-tech product range for our professional retailers, that can be sold online only through the own website of a Cressi authorized retailer. This range therefore cannot be sold on marketplaces, e-procurement platforms or any third party website.

**COMPUTER WATCHES/COMPUTERS**

NEON WATCH COMPUTER  
KING WATCH COMPUTER  
RAFFAELLO DIVING COMPUTER **NEW 2023**

**CONSOLES**

DIGI2 DIGITAL CONSOLE

**REGULATORS**

T10-SC PVD / MASTER REGULATOR (DIN/INT)  
MASTER T10 SC CROMO REGULATOR (DIN/INT)  
AC25m MASTER CHROME REGULATOR (DIN/INT)  
OCTOPUS MG BALANCED REGULATOR

**B.C.D'S**

SCORPION B.C.'D  
AQUAWING B.C.'D  
AQUAWING PLUS B.C.'D  
ELETTRA B.C.'D

**NEOPRENE SUITS**

GLACIER MAN/LADY DRY SUIT 4mm HD **NEW 2023**  
ICE MAN/LADY SEMI-DRY WETSUIT 7mm  
FACILE MAN/LADY MONOPIECE WETSUIT 8mm  
FAST MAN/LADY MONOPIECE WETSUIT 3/5/7mm  
FISTERRA 2-PIECE WETSUIT 5/8mm

**FINS**

THOR EBS FINS  
ARA EBS FINS  
GARA TURBO CARBON FINS  
GARA TURBO CARBON XLD FINS **NEW 2023**  
GARA TURBO CARBON MD FINS **NEW 2023**  
GARA TURBO CARBON HF FINS **NEW 2023**  
GARA TURBO IMPULSE FINS  
GARA MODULAR IMPULSE FINS  
GARA TURBO SPRINT FINS  
GARA MODULAR SPRINT FINS  
GARA MODULAR IMPULSE BLADES

**MASKS**

QUANTUM MASK  
Z1 MASK  
ZS1 MASK  
SF1 MASK  
ATOM MASK **NEW 2023**  
MINIMA MASK

**COMBOS**

QUANTUM + ITACA ULTRA DRY COMBO

**SNORKELS**

ITACA ULTRA DRY SNORKEL

**BAGS & BACKPACKS**

WHALE SCUBA BAG

**KNIVES**

LIZARD KNIFE

**SPEARGUNS**

CHEROKEE POWER RUBBER GUN  
CHEROKEE FAST RUBBER GUN  
CHEROKEE EXO RUBBER GUN  
YUMA FAST GUN  
SAETTA PNEUMATIC GUN W/REDUCER  
SAETTA PNEUMATIC GUN

**SPEARFISHING WETSUITS**

RICCIOLA MAN 2-PIECE WETSUIT 5/7+5mm  
LAMPUGA MAN 2-PIECE WETSUIT 5/7+5mm  
SCORPIONFISH MAN 2-PIECE WETSUIT  
SEPPIA JACKET/PANTS WETSUIT 3.5/5/7mm



# COMPUTER WATCHES

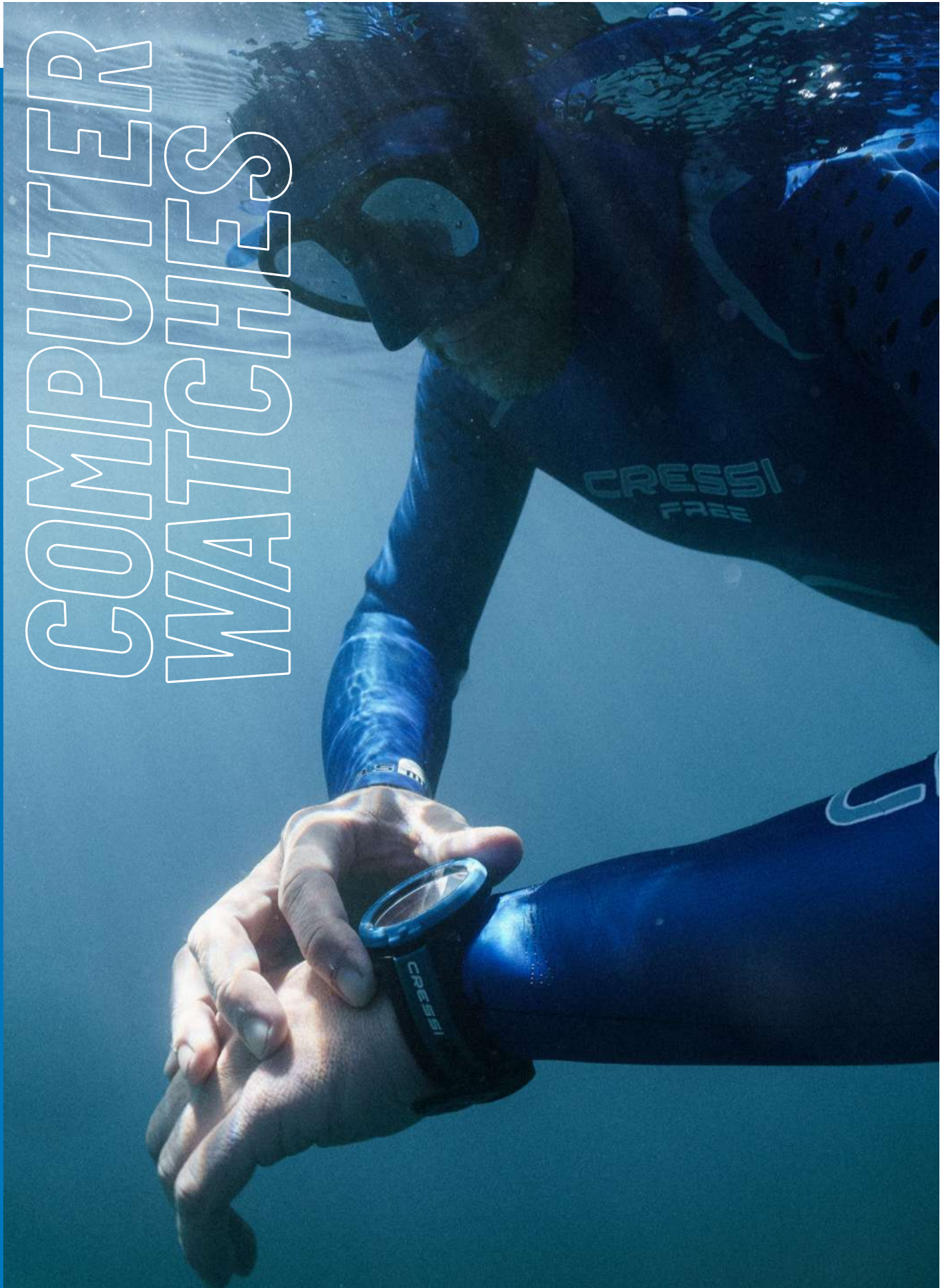



# CARTESIO ATELIER offline product

## SCUBA COMPUTER WATCH

Cartesio has a diameter of only 48mm and a high contrast display of 35mm. It is a scuba diving/apnea watch-computer of extremely reduced dimensions. It is also an ideal watch for other underwater activities, thanks to the deactivation option of the "dive" functions that avoids unnecessary alarms ringing while you're

snorkelling or swimming. The display is made of mineral glass and the case is heavy duty with steel buttons that have an underwater resistance of up to 120m. Rubber wrist band with stainless steel buckle.

ALGORITHM FOR MANAGING TWO DIFFERENT HYPER-OXYGENATED MIXES DURING THE DIVE PHASE.  
GAS1 21-50% GAS2 21-99%

FREEDIVE FUNCTIONS

USER FRIENDLY MENU

LONG-LIFE BATTERY

MINERAL GLASS

HEAVY DUTY CASE

4 OPERATIVE MODES



BLACK

BLACK/METAL

### TECHNICAL FEATURES

- High contrast display with extra large numbers
- Easy access menu
- 12/24 time format with calendar and seconds
- Precision stopwatch
- Second time setting
- Alarm clock
- Backlit display
- Surf time, desaturation and no fly time calculator
- Lets you know when battery is empty
- Metric or imperial units

### AIR/NITROX PROGRAM

- CRESSI RGBM algorithm
- Complete diving data processor
- PPO2 1,2-1,6 configuration
- It is possible to select hyper-oxygenated mixes during the dive phase. GAS1 21-50% GAS2 21-99%
- Graphic indicator of CNS toxicity level of oxygen
- Safety stop indicator
- Multiple level safety factor configuration
- Altitude configuration
- Algorithm for managing uncontrolled ascent
- Suitable for repeated, multiday decompression diving
- It is possible to alternate between nitrox and air diving even during desaturation
- Visualisation of time at dive phase
- Add / remove deep stop
- Alarm in case of breach of ascent speed, decompression or PPO2
- It is possible to disable the ascent alarms
- Indicates time at dive phase
- Possibility of eventual total reset, useful for renting purposes
- Planning: scrolling of no-decompression limits

### FREE (APNEA) PROGRAM

- Display of all diving parameters
- Depth
- Temperature
- Dip counter
- Maximum dive depth
- Dive time
- Length of surface interval between each dive
- Length of diving session
- Depth, dive time and surface interval alarms
- Recovery time alarm
- Visualisation of time at dive phase

### GAUGE PROGRAM (without decompression calculator)

- Depth/temperature indicator
- Average depth
- Dive time in minutes and seconds
- Resettable depth stopwatch
- Visualisation of time at dive phase

### OFF MODE

Sensors disabled for snorkelling/swimming activities

LOGBOOK up to 50 dives per category.

Optional INTERFACE with visualisation of diving profile

PRODUCT	CODE	DLR €	10%	SEASONAL ORDER 20%	RRP €
CARTESIO WATCH/COMPUTER BLACK	KS830050	224,99	202,49	179,99	349,99
CARTESIO WATCH/COMPUTER BLACK METAL	KS830850	224,99	202,49	179,99	349,99



ELITE CASE INCLUDED



# NEON SPECIALIZED

Retailer-Product

## SCUBA COMPUTER WATCH

Neon has a diameter of only 48 mm and a high contrast display of 37 mm. It is a scuba diving/apnea watch-computer of extremely reduced dimensions. It is also an ideal watch for other underwater activities, thanks to the deactivation option of the "dive" functions that avoids unnecessary alarms ringing while you're snorkeling

or swimming. The display is made of mineral glass and the case is heavy duty with steel buttons that have an underwater resistance of up to 120 m. PTU rubber wrist band with stainless steel buckle.

ALGORITHM FOR MANAGING TWO DIFFERENT HYPER-OXYGENATED MIXES DURING THE DIVE PHASE. GAS1 21-50% GAS2 21-99%

FREEDIVE FUNCTIONS

USER FRIENDLY MENU

LONG-LIFE BATTERY

MINERAL GLASS

HEAVY DUTY CASE

4 OPERATIVE MODES



BLUE



GREY



BLACK



RED



GREEN



ORANGE



WHITE/LILAC

### TECHNICAL FEATURES

- High contrast display with extra large numbers
- Easy access menu
- 12/24 time format with calendar and seconds
- Precision stopwatch
- Second time setting
- Alarm clock
- Backlit display
- Surf time, desaturation and no fly time calculator
- Lets you know when battery is empty
- Metric or imperial units

### AIR/NITROX PROGRAM

- CRESSI RGBM algorithm
- Complete diving data processor
- PPO2 1.2-1.6 configuration
- It is possible to select hyper-oxygenated mixes during the dive phase. GAS1 21-50% GAS2 21-99%
- Graphic indicator of CNS toxicity level of oxygen
- Safety stop indicator
- Multiple level safety factor configuration
- Altitude configuration
- Algorithm for managing uncontrolled ascent
- Suitable for repeated, multiday decompression diving
- It is possible to alternate between nitrox and air diving even during desaturation
- Visualisation of time at dive phase
- Add / remove deep stop
- Alarm in case of breach of ascent speed, decompression or PPO2
- It is possible to disable the ascent alarms
- Indicates time at dive phase
- Device completely resettable, useful for renting purposes
- Planning: scrolling of no-decompression limits

### FREE (APNEA) PROGRAM

- Display of all diving parameters
- Depth
- Temperature
- Dip counter
- Maximum dive depth
- Dive time
- Length of surface interval between each dive
- Length of diving session
- Depth, dive time and surface interval alarms
- Recovery time alarm
- Visualisation of time at dive phase

### GAUGE PROGRAM (without decompression calculator)

- Depth/temperature indicator
- Average depth
- Dive time in minutes and seconds
- Resettable depth stopwatch
- Visualisation of time at dive phase

### OFF MODE

Sensors disabled for snorkelling/swimming activities

LOGBOOK up to 50 dives per category

Optional INTERFACE with visualisation of diving profile

PRODUCT	CODE	DLR €	10%	SEASONAL ORDER 20%	RRP €
NEON WATCH COMPUTER BLUE	K5840020	219,99	197,99	175,99	329,99
NEON WATCH COMPUTER GREY	K5840050	219,99	197,99	175,99	329,99
NEON WATCH COMPUTER BLACK	K5840055	219,99	197,99	175,99	329,99
NEON WATCH COMPUTER RED	K5840058	219,99	197,99	175,99	329,99
NEON WATCH COMPUTER GREEN	K5840067	219,99	197,99	175,99	329,99
NEON WATCH COMPUTER ORANGE	K5840085	219,99	197,99	175,99	329,99
NEON WATCH COMPUTER WHITE/LILAC	K5840141	219,99	197,99	175,99	329,99



ELITE CASE INCLUDED



# GOA

## SCUBA COMPUTER WATCH

The GOA has a diameter of only 48mm and a high contrast display of 35mm. It is a scuba diving/apnea watch-computer of extremely reduced dimensions.

It is also an ideal watch for other underwater activities, thanks to the deactivation option of the "dive" functions that avoids unnecessary alarms ringing while you're snorkeling or swimming. The

display is made of mineral glass and the case is heavy duty with steel buttons that have an underwater resistance of up to 120m. Rubber wrist band with stainless steel buckle. Plastic/Steel bezel and back cover.

- MINERAL GLASS
- HEAVY DUTY CASE
- 4 OPERATIVE MODES
- FREEDIVE FUNCTIONS
- USER FRIENDLY MENU
- LONG-LIFE BATTERY



BLACK/GREY

BLACK/BLUE



BLACK/WHITE

WHITE/PINK

WHITE/BLACK

### TECHNICAL FEATURES

- High contrast display with extra large numbers
- Easy access menu
- 12/24 time format with calendar and seconds
- Precision stopwatch
- Second time setting
- Alarm clock
- Backlit display
- Surf time, desaturation and no fly time calculator
- Lets you know when battery is empty
- Metric or imperial units
- Long-lasting battery
- Battery replaceable by user

### AIR/NITROX PROGRAM

- CRESSI RGBM algorithm
- Complete diving data processor
- PPO2 1.2-1.6 configuration
- Graphic indicator of CNS toxicity level of oxygen
- Safety stop indicator
- Multiple level safety factor configuration
- Altitude configuration
- Algorithm for managing uncontrolled ascent
- Suitable for repeated, multiday decompression diving
- It is possible to alternate between nitrox and air diving even during desaturation
- Visualisation of time at dive phase
- Add / remove deep stop
- Alarm in case of breach of ascent speed, decompression or PPO2
- It is possible to disable the ascent alarms
- Indicates time at dive phase
- Possibility of eventual total reset, useful for renting purposes
- Planning: scrolling of no-decompression limits

### FREE (APNEA) PROGRAM

- Display of all diving parameters
- Depth
- Temperature
- Dip counter
- Maximum dive depth
- Dive time
- Length of surface interval between each dive
- Length of diving session
- Depth, dive time and surface interval alarms
- Recovery time alarm
- Visualisation of time at dive phase

### GAUGE PROGRAM (without decompression calculator)

- Depth/temperature indicator
- Average depth
- Dive time in minutes and seconds
- Resettable depth stopwatch
- Visualisation of time at dive phase

### OFF MODE

Sensors disabled for snorkeling/swimming activities

LOGBOOK up to 50 dives per category

Optional INTERFACE with visualisation of diving profile

PRODUCT	CODE	DLR €	10%	SEASONAL ORDER 20%	RRP €
GOA WATCH COMPUTER BLACK/GREY	K5820050	219.99	197.99	175.99	319.99
GOA WATCH COMPUTER BLACK/BLUE	K5820052	219.99	197.99	175.99	319.99
GOA WATCH COMPUTER BLACK/WHITE	K5820053	219.99	197.99	175.99	319.99
GOA WATCH COMPUTER WHITE/PINK	K5820140	219.99	197.99	175.99	319.99
GOA WATCH COMPUTER WHITE/BLACK	K5820150	219.99	197.99	175.99	319.99



/ COMPUTER WATCHES

**KING**



**SPECIALIZED**  
Retailer-Product

**NEW COLOR 2023**

**FREEDIVING COMPUTER WATCH**

With a case diameter of only 48 mm and a high-contrast display of 35 mm, King is an extremely compact watch-computer specific for freediving. This innovative product boasts an algorithm developed in Cressi, which protects the freediver from the risk of Taravana, and a function that avoids the risk of pulmonary edema.

Mineral glass, heavy duty case with steel buttons for resistance to water pressure up to 120 m, metal bezel in AISI 316 steel with surface treatment and Inkfilled technology for the inscription, silicone and polyamide strap (to prevent tears and breakage) with stainless steel buckle.



**NEW**  
SILICONE STRAP  
WITH POLYAMIDE CORE

METAL BEZEL IN AISI 316 STEEL  
WITH SURFACE TREATMENT



BLACK

BLUE

ORANGE

WHITE



TARAVANA  
PROTECTION ALGORITHM

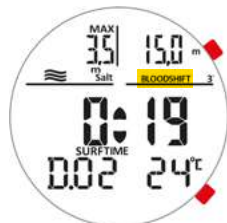

BLOODSHIFT  
PROTECTION ALGORITHM



TIDE  
LEVEL INDICATOR



SINGLE DIP  
LOGBOOK

MINERAL GLASS	HEAVY DUTY CASE	METAL BEZEL	SILICONE STRAP WITH POLYAMIDE CORE
PROTECTION ALGORITHM FROM TARAVANA	EDEMA PROTECTION FUNCTION	USER FRIENDLY MENU	LONG-LASTING BATTERY

**TECHNICAL FEATURES**

- High contrast display
- Easy access menu
- 12/24 time format with calendar and seconds
- Precision stopwatch
- Timer (countdown)
- Second time setting
- Alarm clock
- Backlit display
- Tide indicator
- Low battery indicator
- Metric or imperial units
- Long-lasting battery
- Sleep mode to increase battery life
- Battery replaceable by user

**FREE (FREEDIVING) PROGRAM**

- Taravana risk reduction algorithm with 8 levels
- Pulmonary edema risk reduction function with approach dive calculation
- Display of all diving parameters
- Depth
- Temperature
- Dip counter
- Maximum dive depth
- Dive time
- Length of surface interval between each dive
- Length of diving session
- Maximum descent and ascent speed indication
- Depth, dive time and surface interval alarms
- Recovery time alarm
- Hydration alarm
- Alarms that can be set at dive phase
- Fresh/salt water setting
- Lock mode for snorkeling or swimming activities

**LOGBOOK**

- Variable data logging interval
- Available during the diving session
- Indication of session parameters and of each dive

**INTERFACE**

Optional with visualisation of diving profile



SILICONE PROTECTIVE LENS INCLUDED



ELITE CASE INCLUDED

PRODUCT	CODE	DLR €	10%	SEASONAL ORDER 20%	RRP €
KING WATCH COMPUTER BLACK	K5842050	212,49	191,24	169,99	299,99
KING WATCH COMPUTER BLUE	K5842020	212,49	191,24	169,99	299,99
KING WATCH COMPUTER ORANGE	K5842085	212,49	191,24	169,99	299,99
KING WATCH COMPUTER WHITE	K5842030	212,49	191,24	169,99	299,99



# NEPTO

## FREEDIVING COMPUTER WATCH

With a case diameter of only 48 mm and a high-contrast display of 35 mm, Nepto is an extremely compact watch-computer specific for freediving. This innovative product boasts an algorithm developed in Cressi, which protects the freediver from the risk of Taravana, and a function that

avoids the risk of pulmonary edema. Mineral glass, heavy duty case with steel buttons for resistance to water pressure up to 120 m, rubber strap with stainless steel buckle.

- MINERAL GLASS
- HEAVY DUTY CASE
- PROTECTION ALGORITHM FROM TARAVANA
- EDEMA PROTECTION FUNCTION
- USER FRIENDLY MENU
- LONG-LIFE BATTERY



BLACK



BLUE



GREEN



TARAVANA PROTECTION ALGORITHM



BLOODSHIFT PROTECTION ALGORITHM



TIDE LEVEL INDICATOR



SINGLE DIP LOGBOOK

### TECHNICAL FEATURES

- High contrast display
- Easy access menu
- 12/24 time format with calendar and seconds
- Precision stopwatch
- Timer (countdown)
- Dual timer
- Second time setting
- Alarm clock
- Backlit display
- Tide indicator
- Low battery indicator
- Metric or imperial units
- Long-lasting battery
- Sleep mode to increase battery life
- Battery replaceable by user

### FREE (FREEDIVING) PROGRAM

- Taravana risk reduction algorithm with 8 levels
- Pulmonary edema risk reduction function with approach dive calculation
- Display of all diving parameters
- Depth
- Temperature
- Dip counter
- Maximum dive depth
- Dive time
- Length of surface interval between each dive
- Length of diving session
- Maximum descent and ascent speed indication
- 5-Depth, dive time and surface interval alarms
- Recovery time alarm
- Hydration alarm
- Alarms that can be set at dive phase
- Fresh/salt water setting
- Lock mode for snorkeling or swimming activities

### LOGBOOK

- Variable data logging interval
- Available during the diving session
- Indication of session parameters and of each dive

### INTERFACE

Optional with visualisation of diving profile



PRODUCT	CODE	DLR €	10%	SEASONAL ORDER 20%	RRP €
NEPTO WATCH COMPUTER BLACK	K5841050	174,99	157,49	139,99	259,99
NEPTO WATCH COMPUTER BLUE	K5841020	174,99	157,49	139,99	259,99
NEPTO WATCH COMPUTER GREEN	K5841098	174,99	157,49	139,99	259,99

# BT INTERFACE WATCHES

## BLUETOOTH/USB

External docking station to send data to your smartphone – compatible with Android (from OS version 9.0 onwards) and iOS (from OS version 12 onwards) – or to transfer data on PC (from Windows 10 onwards) and Mac (from Sierra onwards) through USB connection. The docking

station is equipped with a CR 2032 battery included and replaceable by the user, which allows not to consume the internal battery of the dive computer. The specific App is available on the Google Play Store, App Store, Huawei App Gallery.



Download "Cressi" App and explore your dives on your smartphone.



### INTERFACE COMPATIBILITY

<b>Android OS</b>	From OS version 9.0 onwards
<b>Apple IOS</b>	From OS version 12 onwards
<b>Windows OS</b>	From Windows 10 onwards
<b>Mac OS</b>	From Sierra onwards
<b>Connection</b>	USB CABLE Bluetooth

### Computer watches

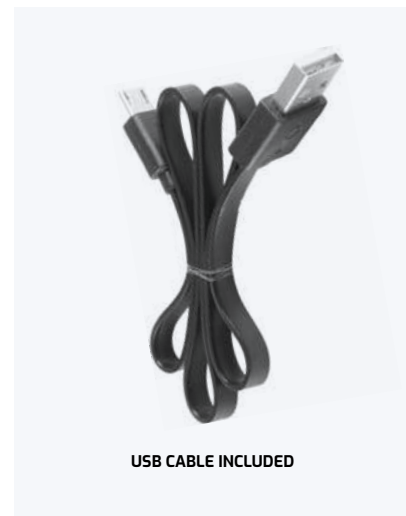
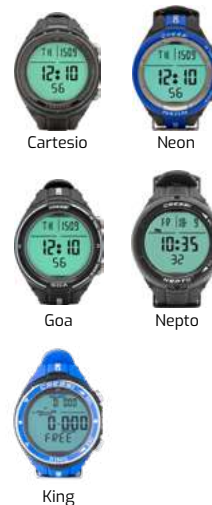

PRODUCT	CODE	DLR €	10%	SEASONAL ORDER 20%	RRP €
INTERFACE BT WATCH STYLE COMPUTER	KS822001	62.49	56.24	49.99	89.99



## SILICONE LENS COVER

MAGNIFYNG EFFECT  
+15% LARGER DISPLAY NUMBERS



PRODUCT	CODE	DLR €	10%	SEASONAL ORDER 20%	RRP €
SIL.PROTECTIVE LENS WATCH STYLE COMPUTER SCREEN	K5890000	7.49	6.74	5.99	11,99

**DESCRIPTION:**

The lens eliminates almost completely the effects of abrasion and shocks on both the display and the sides of the bezel, while making for perfect visibility. Thanks to this protection, the dive computer retains its pleasing, undamaged appearance even after prolonged, intensive underwater use.

**COMPATIBILITY:**

Cartesio, Neon, Goa, Nepto, King

## BATTERY SPARE PARTS



PRODUCT	CODE	DLR €	10%	SEASONAL ORDER 20%	RRP €
O-RING + CASE BACK SCREWS WATCH STYLE COMPUTER	KZ901000	7.49	6.74	5.99	11,99
BATTERY KIT CR2450 (O-RING+SCREWS) WATCH STYLE COMPUTER	KZ820094	8.74	7.87	6.99	13,99

**DESCRIPTION:**

Replacement spare part kits for computer watches

**COMPATIBILITY:**

Cartesio, Neon, Goa, Nepto, King

## COMP. WATCH SCREW STRAP



PRODUCT	CODE	DLR €	10%	SEASONAL ORDER 20%	RRP €
SCREW STRAP W/NUT WATCH STYLE COMPUTER	KZ805099	11.24	10.12	8.99	17,99

**DESCRIPTION:**

Stainless steel screw + nut for computer watches strap

**COMPATIBILITY:**

Cartesio, Neon, Goa, Nepto, King

## SILICONE WATCHBANDS

POLYAMIDE CORE  
PREVENT TEARS AND BREAKAGE



**COMPATIBILITY:**

Cartesio, Neon, Goa, King, Nepto

PRODUCT	CODE	DLR €	10%	SEASONAL ORDER 20%	RRP €
SILICONE WATCHBAND BLACK	KZ842050	25.63	23.07	20.50	40,99
SILICONE WATCHBAND BLUE	KZ842020	25.63	23.07	20.50	40,99
SILICONE WATCHBAND ORANGE	KZ842085	25.63	23.07	20.50	40,99
SILICONE WATCHBAND WHITE	KZ842030	25.63	23.07	20.50	40,99

## COMP. WATCHBANDS



PRODUCT	CODE	DLR €	10%	SEASONAL ORDER 20%	RRP €
NEPTO WATCHBAND BLACK/DARK GREEN	KZ841098	19.38	17.44	15.50	30,99
GOA/NEON/NEPTO WATCHBAND BLACK/BLACK	KZ840055	19.38	17.44	15.50	30,99
NEON/NEPTO WATCHBAND BLACK/BLUE	KZ840020	19.38	17.44	15.50	30,99
NEON WATCHBAND BLACK/ORANGE	KZ840085	19.38	17.44	15.50	30,99
NEON WATCHBAND WHITE/LILAC	KZ840141	19.38	17.44	15.50	30,99
NEON WATCHBAND BLACK/GREY	KZ840050	19.38	17.44	15.50	30,99
NEON WATCHBAND BLACK/LIME	KZ840067	19.38	17.44	15.50	30,99
NEON WATCHBAND BLACK/RED	KZ840058	19.38	17.44	15.50	30,99
GOA WATCHBAND BLACK/GREY	KZ820050	19.38	17.44	15.50	30,99
GOA WATCHBAND BLACK/BLUE	KZ820052	19.38	17.44	15.50	30,99
GOA WATCHBAND WHITE/BLACK	KZ820150	19.38	17.44	15.50	30,99
GOA WATCHBAND WHITE/PINK	KZ820140	19.38	17.44	15.50	30,99
CARTESIO WATCHBAND BLACK/BLACK	KZ8230050	19.38	17.44	15.50	30,99

## WATCHBAND EXTENSOR

ADDITIONAL LENGHT  
+4 IN / 10 CM



PRODUCT	CODE	DLR €	10%	SEASONAL ORDER 20%	RRP €
WATCHBAND EXTENSOR WATCH COMPUTER	KZ810000	14.99	13.49	11.99	23,99

**DESCRIPTION:**

Designed for wear the Cressi Dive Watch over a thick wetsuit. Made with the same high-quality rubber and corrosion resistant materials of the original straps. Easily clasps on the buckle end of computers strap increasing it length.

**COMPATIBILITY:**

Cartesio, Neon, Goa, Nepto, King

# COMPUTERS





# RAFFAELLO

**SPECIALIZED**  
Retailer-Product

NEW 2023

ALGORITHM FOR MANAGING DIFFERENT HYPER-OXYGENATED MIXES DURING THE DIVE PHASE.  
GAS1 21-50% GAS2 21-99% GAS3 21-99%

FREEDIVING FUNCTION

## RECTANGULAR WIDE SCREEN SCUBA DIVING COMPUTER

Raffaello is a diving computer with a flat, large display. It is thought to give the diver the maximum data readability. Despite its thinness and lightness it is very resistant and robust. The body of Raffaello reinforced material through micro-structured nano charges. It features a mineral Borosilicate glass, extremely resistant to scratches. Two sturdy metal buttons allow for an easy access to data menus. They will not lock and function in any water

condition, even in the presence of mud. The wrist band is made of silicon. It is safe, robust and comfortable at the same time. The circuit architecture and its new generation components allow an extremely long battery life



### TECHNICAL FEATURES

- High contrast display. Very large numbers, position for an easy reading.
- Intuitive, easy access menu
- 12/24 time, with seconds and calendar
- Precision stop watch
- Double time zone
- Alarm
- Back lighted display
- Surface time, Desaturation time, no fly time
- Low battery warning
- Metric or imperial measures
- Long lasting battery
- User replaceable battery

### DIVE (AIR/NITROX) PROGRAM

- Cressi RGBM Algorithm
- Complete dive data elaborator
- PPO2 1.2-1.6 setting
- Different air mixes manageable during the dive: GAS 1 21-50% GAS 2 21-99% GAS3 21-99%
- Graphis indicator of oxygen toxicity levels at CNS
- Safety stop indicator
- Safety factor can be set at different levels
- Altitude setting
- Uncontrolled emersion algorithm
- Repeated dives over decompression limits are possible.
- Possibility to alternate Nitrox and Air dives during desaturation
- Time visible during the dive
- Possibility to insert/cancel a Deep stop
- Loud alarms in case of violation of ascent speed, decompression stop or PPO2
- Ascent alarms can be disabled
- Total reset possible. Useful for rentals.
- Possibility to tan dives without decompression

### FREE (APNEA) PROGRAM

- Visualization of all diving data
- Depth
- Water temperature
- Dive counter
- Maximum depth of the dive
- Dive time
- Surface interval between dives
- Duration of the diving session
- Surface interval
- Recovery time alarm

### GAGE PROGRAM (without decompression calculator)

- Depth/temperature indicator
- Average depth
- Dive time in minutes/seconds
- Depth chronometer can be reset
- Daytime visible during dive

### OFF MODE

- Sensors are disabled to allow snorkeling and swimming

LOGBOOK to 50 dives per program type

PRODUCT	CODE	DLR €	10%	SEASONAL ORDER 20%	RRP €
RAFFAELLO DIVING COMPUTER BLACK/BLUE	KS880052	249.99	224.99	199.99	369.99



# MICHELANGELO



## SCUBA DIVING COMPUTER

Michelangelo has a high contrast display. It is a scuba diving/apnea computer. It is an ideal computer for other underwater activities, thanks to the deactivation option of the "dive" functions that avoids unnecessary alarms ringing while you're snorkeling or swimming. The display is made of

technical polyolefin and the case is heavy duty, with a steel button. The underwater resistance is up to 150 m. TPU rubber wrist band with stainless steel buckle.



BLACK



BLACK/METAL



BLACK/COPPER

ALGORITHM FOR MANAGING TWO DIFFERENT HYPER-OXYGENATED MIXES DURING THE DIVE PHASE. GAS1 21-50% GAS2 21-99%

FREEDIVING FUNCTION

### TECHNICAL FEATURES

- High contrast display with extra large numbers
- Easy access menu
- 12/24 time format with calendar
- High power backlit display
- Surf time, desaturation and no fly time calculator
- Lets you know when battery is empty
- Metric or imperial units

### AIR/NITROX PROGRAM

- CRESSI RGBM algorithm
- Complete diving data processor
- PPO2 1.2-1.6 configuration
- It is possible to select hyper-oxygenated mixes during the dive phase. GAS1 21-50% GAS2 21-99%
- Graphic indicator of CNS toxicity level of oxygen
- Safety stop indicator
- Multiple level safety factor configuration
- Altitude configuration
- Algorithm for managing uncontrolled ascent
- Suitable for repeated, multiday decompression diving
- It is possible to alternate between nitrox and air diving even during desaturation
- Visualisation of time while diving
- Add / remove deep stop
- Alarm in case of breach of ascent speed, decompression or PPO2
- It is possible to disable the ascent alarms
- Possibility of eventual total reset, useful for renting purposes
- Planning: scrolling of no-decompression limits
- Maximum dive depth alarm

### FREE (APNEA) PROGRAM

- Display of all diving parameters
- Depth
- Temperature
- Dip counter
- Maximum dive depth alarm
- Dive time
- Length of surface interval between each dive
- Length of diving session
- Depth, dive time and surface interval alarms
- Recovery time alarm
- Visualisation of time at dive phase

### GAUGE PROGRAM (without decompression calculator)

- Depth/temperature indicator
- Average depth
- Dive time in minutes and seconds
- Resettable depth stopwatch
- Visualisation of time at dive phase

### LOGBOOK up to 50 dives per category

Replaceable **PROTECTIVE DISPLAY** screen  
User-replaceable batteries  
Structural metal bezel that gives greater impact resistance

Optional **INTERFACE** with visualisation of diving profile

PRODUCT	CODE	DLR €	10%	SEASONAL ORDER 20%	RRP €
MICHELANGELO DIVING COMPUTER BLACK	KS850050	174,99	157,49	139,99	299,99
MICHELANGELO DIVING COMPUTER BLACK METAL	KS850850	174,99	157,49	139,99	299,99
MICHELANGELO DIVING COMPUTER BLACK/COPPER	KS850950	174,99	157,49	139,99	299,99



ELITE CASE INCLUDED



# DONATELLO

## SCUBA DIVING COMPUTER

Donatello is an underwater and freediving computer. It is ideal for other water activities, thanks to the deactivation option of the "dive" functions, that avoids unnecessary alarms while snorkeling or swimming. It has a high contrast display. The heavy-duty case with a steel button

is fitted with a bezel which, like the protection, is plastic made. The underwater resistance is up to 150 m. The two-tone wrist band is made of TPU rubber with a stainless steel buckle.



### TECHNICAL FEATURES

- High contrast display with extra large numbers
- Easy access menu
- 12/24 time format with calendar
- High power backlit display
- Surf time, desaturation and no fly time calculator
- Lets you know when battery is empty
- Metric or imperial units

### DIVE (AIR/NITROX) PROGRAM

- CRESSI RGBM algorithm
- Complete diving data processor
- PPO2 1.2-1.6 configuration
- Graphic indicator of CNS toxicity level of oxygen
- Safety stop indicator
- Multiple level safety factor configuration
- Altitude configuration
- Algorithm for managing uncontrolled ascent
- Suitable for repeated, multiday decompression diving
- Visualisation of time while diving
- Add / remove deep stop
- Alarm in case of breach of ascent speed, decompression or PPO2
- It is possible to disable the ascent alarms
- Possibility of eventual total reset, useful for renting purposes
- Planning: scrolling of no-decompression limits
- Maximum dive depth alarm

### FREE (APNEA) PROGRAM

- Display of all diving parameters
- Depth
- Temperature
- Dip counter
- Maximum dive depth alarm
- Dive time
- Length of surface interval between each dive
- Length of diving session
- Depth, dive time and surface interval alarms
- Recovery time alarm
- Visualisation of time at dive phase

### GAGE PROGRAM (without decompression calculator)

- Depth/temperature indicator
- Average depth
- Dive time in minutes and seconds
- Resettable depth stopwatch
- Visualisation of time at dive phase

### LOGBOOK up to 50 dives per category

Replaceable **PROTECTIVE DISPLAY** screen  
User-replaceable batteries

Optional **INTERFACE** with visualisation of diving profile

PRODUCT	CODE	DLR €	10%	SEASONAL ORDER 20%	RRP €
DONATELLO DIVING COMPUTER BLACK/BLUE	K5860022	156.24	140.62	124.99	248.75
DONATELLO DIVING COMPUTER BLACK/SILVER	K5860051	156.24	140.62	124.99	248.75
DONATELLO DIVING COMPUTER BLACK/RED	K5860058	156.24	140.62	124.99	248.75
DONATELLO DIVING COMPUTER BLACK/YELLOW	K5860052	156.24	140.62	124.99	248.75
DONATELLO DIVING COMPUTER BLACK/PINK	K5860054	156.24	140.62	124.99	248.75



# LEONARDO

## SCUBA DIVING COMPUTER

An elegant expression of simple, functional design, the Leonardo is a must-have for divers entering the sport and those who "just want to dive." A single button interface makes it effortless to program Air, Nitrox and Gauge modes the first time a diver picks the computer up, and an edge-to-edge, high-definition screen gives large numerical displays in a computer that is still compact and travel-friendly.

The clearly visible battery life indicator and distinct audible alarms deliver critical information as well as peace-of-mind during the dive. The Leonardo can also be fully re-set after each use, making it an excellent choice for rental departments

### TECHNICAL FEATURES

- Air, Nitrox and Gauge modes
- PO2 adjustable between 21% and 50%
- PO2 adjustable between 1.2 bar and 1.6 bar
- CNS oxygen toxicity graphic indicator
- Single button interface (short push changes function, longer push selects functions)
- Three levels of user-adjustable conservatism
- User-selectable Deep Stop function
- Modified Haldne and Wienke algorithm
- Ascent rate alarm (10 m per minute)
- Log book for 60 dives/75 hours of information with 20-second sampling rate
- Battery life indicator
- Distinct, easy-to-hear audible alarms
- User changeable battery
- Adjustable unit of measure: English or Metric
- Backlit display
- Built-in calendar and clock
- Possibility of eventual total reset, useful for renting purposes



BLACK/BLACK



BLACK/GREY



BLACK/YELLOW



BLACK/BLUE



BLACK/PINK



WHITE/BLACK



PRODUCT	CODE	DLR €	10%	SEASONAL ORDER 20%	RRP €
LEONARDO DIVING COMPUTER BLACK/BLACK	KS770000	162.49	146.24	129.99	223.75
LEONARDO DIVING COMPUTER BLACK/GREY	KS770050	162.49	146.24	129.99	223.75
LEONARDO DIVING COMPUTER BLACK/YELLOW	KS770051	162.49	146.24	129.99	223.75
LEONARDO DIVING COMPUTER BLACK/BLUE	KS770052	162.49	146.24	129.99	223.75
LEONARDO DIVING COMPUTER BLACK/PINK	KS770054	162.49	146.24	129.99	223.75
LEONARDO DIVING COMPUTER WHITE/BLACK	KS770150	162.49	146.24	129.99	223.75





# MICHELANGELO 2

2 INSTRUMENTS CONSOLE

## COMPUTER + PRESSURE GAUGE

### MINI PRESSURE GAUGE

It is a small, light-weight gauge that has been specifically designed to avoid excessive strain on the HP hose that connects to the first stage of the regulator. The instrument has a metal case in chromium plated brass and is therefore extremely strong. The front glass is made so that it also acts as a pressure relief valve. In the event of a sudden increase in pressure inside the instrument, the glass rises slightly, allowing the excess pressure to escape. The luminescent dial is calibrated up to 350 bar in the metric version and 5000 psi in the imperial one. The area below 50 bar is highlighted in red, the one between 50 and 200 is green and that from 200 to the end of the scale is light blue.

The instrument is housed in a small, modern shaped console, made from polycarbonate and desmopan, two materials that guarantee protection from shocks and scratches and which, at the same time, are very light. On the top of the console there is a loop for fastening the instrument to the jacket so that it does not hang down with the risk of catching and damaging the environment.



ELITE CASE INCLUDED

PRODUCT	CODE	DLR €	10%	SEASONAL ORDER 20%	RRP €
CONSOLE MICHELANGELO 2 BAR	KS852950	262,49	236,24	209,99	419,99
CONSOLE MICHELANGELO 2 PSI	KS852955	262,49	236,24	209,99	419,99

# MICHELANGELO 3

3 INSTRUMENTS CONSOLE

## COMPUTER + COMPASS + PRESSURE GAUGE

It is the three-instrument version of the Michelangelo 2 console, equipped with the Michelangelo computer, a mini manometer and a compass.



ELITE CASE INCLUDED

PRODUCT	CODE	DLR €	10%	SEASONAL ORDER 20%	RRP €
CONSOLE MICHELANGELO 3 BAR	KS853950	299,99	269,99	239,99	479,99
CONSOLE MICHELANGELO 3 PSI	KS853955	299,99	269,99	239,99	479,99



2 INSTRUMENTS  
CONSOLE

# DONATELLO 2

## COMPUTER + PRESSURE GAUGE

### MINI PRESSURE GAUGE

It is a small, light-weight gauge that has been specifically designed to avoid excessive strain on the HP hose that connects to the first stage of the regulator. The instrument has a metal case in chromium plated brass and is therefore extremely strong. The front glass is made so that it also acts as a pressure relief valve. In the event of a sudden increase in pressure inside the instrument, the glass rises slightly, allowing the excess pressure to escape. The luminescent dial is calibrated up to 350 bar in the metric version and 5000 psi in the imperial one. The area below 50 bar is highlighted in red, the one between 50 and 200 is green and that from 200 to the end of the scale is light blue.

The instrument is housed in a small, modern shaped console, made from polycarbonate and desmopan, two materials that guarantee protection from shocks and scratches and which, at the same time, are very light.

On the top of the console there is a loop for fastening the instrument to the jacket so that it does not hang down with the risk of catching and damaging the environment.



ELITE CASE INCLUDED

PRODUCT	CODE	DLR €	10%	SEASONAL ORDER 20%	RRP €
DONATELLO CONSOLE 2 BAR	KS870210	239.99	215.99	191.99	384.99
DONATELLO CONSOLE 2 PSI	KS870220	239.99	215.99	191.99	384.99

# DONATELLO 3

## COMPUTER + COMPASS + PRESSURE GAUGE

It is the three-instrument version of the Donatello 2 console, equipped with the Donatello computer, a mini manometer and a compass.



3 INSTRUMENTS  
CONSOLE



ELITE CASE INCLUDED

PRODUCT	CODE	DLR €	10%	SEASONAL ORDER 20%	RRP €
DONATELLO CONSOLE 3 BAR	KS871210	274.99	247.49	219.99	444.99
DONATELLO CONSOLE 3 PSI	KS871220	274.99	247.49	219.99	444.99



# BT INTERFACE

## BLUETOOTH/USB

External docking station to send data to your smartphone – compatible with Android (from OS version 9.0 onwards) and iOS (from OS version 12 onwards) – or to transfer data on PC (from Windows 10 onwards) and Mac (from Sierra onwards) through USB connection. The docking

station is equipped with a CR 2032 battery included and replaceable by the user, which allows not to consume the internal battery of the dive computer. The specific App is available on the Google Play Store, App Store, Huawei App Gallery.



Download "Cressi" App and explore your dives on your smartphone.



### INTERFACE COMPATIBILITY

<b>Android OS</b>	From OS version 9.0 onwards
<b>Apple IOS</b>	From OS version 12 onwards
<b>Windows OS</b>	From Windows 10 onwards
<b>Mac OS</b>	From Sierra onwards

**Connection** USB CABLE  
Bluetooth

#### Computer watches



Michelangelo Donatello

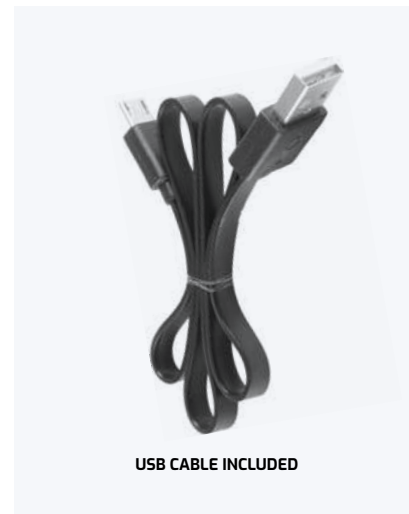

USB CABLE INCLUDED

PRODUCT	CODE	DLR €	10%	SEASONAL ORDER 20%	RRP €
INTERFACE BT MICHELANGELO-DONATELLO	KS851000	62,49	56,24	49,99	89,99

## PROTECTIVE LENS



PRODUCT	CODE	DLR €	10%	SEASONAL ORDER 20%	RRP €
PROTECTIVE LENS MICHELANGELO/DONATELLO SCREEN	KZ850098	7,49	6,74	5,99	11,99
PROTECTIVE LENS GIOTTO SCREEN	KZ740098	7,49	6,74	5,99	11,99
PROTECTIVE LENS LEONARDO SCREEN	KZ770098	7,49	6,74	5,99	11,99

**DESCRIPTION:**

The lens eliminates almost completely the effects of abrasion and shocks while making for perfect visibility.

## COMPUTER BATTERY KIT



PRODUCT	CODE	DLR €	10%	SEASONAL ORDER 20%	RRP €
O-RING + CAP BIG SCREEN COMPUTER	KZ901001	7,49	6,74	5,99	11,99
BATTERY KIT CR2430 (O-RING+CAP) BIG SCREEN COMPUTER	KZ770094	8,74	7,87	6,99	13,99

**DESCRIPTION:**

Replacement spare part kits for big screen dive computers

**COMPATIBILITY:**

- Giotto computer
- Leonardo computer
- Donatello computer
- Michelangelo computer



PRODUCT	CODE	DLR €	10%	SEASONAL ORDER 20%	RRP €
BATTERY KIT FOR RAFFAELLO (CR2450 + O-RING)	KZ820094	8,74	7,87	6,99	13,99

**DESCRIPTION:**

Replacement spare part kits for rectangular wide screen dive computers

**COMPATIBILITY:**

- Raffaello computer

## ELITE PROTECTIVE CASE



PRODUCT	CODE	DLR €	10%	SEASONAL ORDER 20%	RRP €
ELITE PROTECTIVE CASE	KZ700000	8,13	7,32	6,50	12,99

## COMPUTER WATCHBAND



PRODUCT	CODE	DLR €	10%	SEASONAL ORDER 20%	RRP €
RAFFAELLO WATCHBAND BLACK	KZ885050	24,99	22,49	19,99	39,99
MICHELANGELO/DONATELLO WATCHBAND BLACK/BLACK	KZ850097	18,13	16,32	14,50	28,99
LEONARDO WATCHBAND BLACK/BLACK	KZ770000	18,13	16,32	14,50	28,99
LEONARDO WATCHBAND BLACK/BLUE	KZ770020	18,13	16,32	14,50	28,99
LEONARDO WATCHBAND BLACK/PINK	KZ770040	18,13	16,32	14,50	28,99
LEONARDO WATCHBAND BLACK/GRAY	KZ770050	18,13	16,32	14,50	28,99
LEONARDO WATCHBAND WHITE/BLACK	KZ770150	18,13	16,32	14,50	28,99
LEONARDO WATCHBAND BLACK/YELLOW	KZ770051	18,13	16,32	14,50	28,99

## COMPUTER SCREW STRAP



PRODUCT	CODE	DLR €	10%	SEASONAL ORDER 20%	RRP €
SCREW WATCHBAND (1pair) BIG SCREEN COMPUTER	KZ760525	11,24	10,12	8,99	17,99

**DESCRIPTION:**

Stainless steel screw + nut for big screen dive computers

**COMPATIBILITY:**

- Giotto computer
- Leonardo computer
- Donatello computer
- Michelangelo computer
- Raffaello computer





/ COMPUTERS COMPARISON TABLE



	CARTESIO	NEON	GOA	RAFFAELLO	MICHELANGELO	DONATELLO	LEONARDO		KING	NEPTO		
<b>Case diameter</b>	1 7/8 in · 48 mm	1 7/8 in · 48 mm	1 7/8 in · 48 mm	70x55	2 5/8 in · 67 mm	2 5/8 in · 67 mm	2 5/8 in · 67 mm	<b>Case diameter</b>	1 7/8 in · 48 mm	1 7/8 in · 48 mm		
<b>Display diameter</b>	1 3/8 in · 35 mm	1 3/8 in · 35 mm	1 3/8 in · 35 mm	51x35	1.85 in · 47 mm	1.85 in · 47 mm	1 7/8 in · 47 mm	<b>Display diameter</b>	1 3/8 in · 35 mm	1 3/8 in · 35 mm		
<b>Case thickness</b>	5/8 in · 15.8 mm	5/8 in · 15.8 mm	5/8 in · 15.8 mm	18	1 1/16 in · 27 mm	1 1/16 in · 27 mm	1 1/16 in · 27 mm	<b>Case thickness</b>	5/8 in · 15.8 mm	5/8 in · 15.8 mm		
<b>Weight</b>	3.2 oz · 92 g	3.2 oz · 92 g	3.1 oz · 87 g	150 g	4.7 oz · 135 g	4.7 oz · 135 g	4.8 oz · 135 g	<b>Weight</b>	3.2 oz · 92 g	3.2 oz · 92 g		
<b>Buttons</b>	2	2	2	2	1	1	1	<b>Buttons</b>	2	2		
<b>Backlit display</b>	Yes	Yes	Yes	Yes	Yes	Yes	Yes	<b>Backlit display</b>	Yes	Yes		
<b>Dive programs</b>	Air · Nitrox · Gauge · Free	Air · Nitrox · Gauge · Free	Air · Nitrox · Gauge · Free	Air · Nitrox · Gauge · Free	Air · Nitrox · Gauge · Free	Air · Nitrox · Gauge · Free	Air · Nitrox · Gauge · Free	<b>Dive programs</b>	Free · Lock · Sleep	Free · Lock · Sleep		
<b>Max dive time</b>	1,032 min	1,032 min	1,032 min	1,032 min	1,032 min	1,032 min	255 min	<b>Max dive time</b>	-	-		
<b>Max depth</b>	393 ft · 120 m	393 ft · 120 m	393 ft · 120 m	393 ft · 120 m	393 ft · 120 m	393 ft · 120 m	393 ft · 120 m	<b>Max depth</b>	393 ft · 120 m	393 ft · 120 m		
<b>Average depth</b>	Yes	Yes	Yes	Yes	Yes	Yes	No	<b>Average depth</b>	-	-		
<b>Depth sampling rate</b>	1 second	1 second	1 second	0.5 second	1 second	1 second	1 second	<b>Depth sampling rate</b>	0.5 second	0.5 second		
<b>Algorithm</b>	Dual-mixture Cressi-Wienke RGBM with Uncontrolled Ascent Protection Algorithm	Dual-mixture Cressi-Wienke RGBM with Uncontrolled Ascent Protection Algorithm	Air/Nitrox Cressi-Wienke RGBM with Uncontrolled Ascent Protection Algorithm	Trial-mixture - Cressi-Wienke RGBM with Uncontrolled Ascent Protection Algorithm	Dual-mixture Cressi-Wienke RGBM with Uncontrolled Ascent Protection Algorithm	Cressi-Wienke RGBM with Uncontrolled Ascent Protection Algorithm	Air Nitrox Cressi-Wienke RGBM	<b>Algorithm</b>	Taravana protection algorithm Edema protection algorithm	Taravana protection algorithm Edema protection algorithm		
<b>Thermometer</b>	Resolution: 1°F / 1°C Measuring field: 23°F + 104°F (-5°C + 40°C) Precision: 3.6°F (2°C) / 10 min change temp	Resolution: 1°F / 1°C Measuring field: 23°F + 104°F (-5°C + 40°C) Precision: 3.6°F (2°C) / 10 min change temp	Resolution: 1°F / 1°C Measuring field: 23°F + 104°F (-5°C + 40°C) Precision: 3.6°F (2°C) / 10 min change temp	Resolution: 1°F / 1°C - Measuring field: 23°F + 104°F (-5°C + 40°C) - Precision: 3.6°F (2°C) / 10 min change temp	Resolution: 1°F / 1°C Measuring field: 23°F + 104°F (-5°C + 40°C) Precision: 3.6°F (2°C) / 10 min change temp	Resolution: 1°F / 1°C Measuring field: 23°F + 104°F (-5°C + 40°C) Precision: 3.6°F (2°C) / 10 min change temp	Resolution: 1°F / 1°C Measuring field: 23°F + 104°F (-5°C + 40°C) Precision: 3.6°F (2°C) / 10 min change temp	Resolution: 1°F / 1°C Measuring field: 23°F + 104°F (-5°C + 40°C) Precision: 3.6°F (2°C) / 10 min change temp	<b>Thermometer</b>	Resolution: 1°F / 1°C Measuring field: 23°F + 104°F (-5°C + 40°C) Precision: 3.6°F (2°C) / 10 min change temp	Resolution: 1°F / 1°C Measuring field: 23°F + 104°F (-5°C + 40°C) Precision: 3.6°F (2°C) / 10 min change temp	
<b>Visual and Auditory alarms</b>	Yes	Yes	Yes	Yes	Yes	Yes	Yes	<b>Visual and Auditory alarms</b>	Yes	Yes		
<b>Ascent alarm</b>	On / Off	On / Off	On / Off	On / Off	On / Off	On / Off	Permanent	<b>Alarms</b>	Surf, Depth, Dive, Step time (available during the dive) Hydration	Surf, Depth, Dive, Step time (available during the dive) Hydration		
<b>Deep stop</b>	On / Off	On / Off	On / Off	On / Off	On / Off	On / Off	On / Off					
<b>Tissue saturation</b>	9 saturation half-times ranging from 2.5 to 480 minutes	9 saturation half-times ranging from 2.5 to 480 minutes	9 saturation half-times ranging from 2.5 to 480 minutes	10 saturation half-times ranging from 2.5 to 480 minutes	9 saturation half-times ranging from 2.5 to 480 minutes	9 saturation half-times ranging from 2.5 to 480 minutes	9 saturation half-times ranging from 2.5 to 480 minutes					
<b>PO2 parameters</b>	1.2 bar - 1.6 bar	1.2 bar - 1.6 bar	1.2 bar - 1.6 bar	1.2 bar - 1.6 bar	1.2 bar - 1.6 bar	1.2 bar - 1.6 bar	1.2 bar - 1.6 bar					
<b>FO2 parameters</b>	Mix1: 21% to 50% Mix2: 21% to 99%	Mix1: 21% to 50% Mix2: 21% to 99%	Mix1: 21% to 50%	Mix1: 21% to 50% - Mix2: 21% to 99% - Mix3: 21% to 99%	Mix1: 21% to 50% Mix2: 21% to 99%	Mix1: 21% to 50%	21% to 50%	<b>Water salinity</b>	Fresh/Salt	Fresh/Salt		
<b>Stopwatch during Gage mode</b>	Yes, resettable	Yes, resettable	Yes, resettable	Yes, resettable	Yes, resettable	Yes, resettable	No	<b>Tide level indicator</b>	Yes	Yes		
<b>Clock (during the dive)</b>	Yes	Yes	Yes	Yes	Yes	Yes	No	<b>No-fly time</b>	Yes	Yes		
<b>No-fly time</b>	Yes	Yes	Yes	Yes	Yes	Yes	Yes	<b>Altitude diving</b>				
<b>Altitude diving</b>	Yes until 12,140 ft 3,700m	Yes until 12,140 ft 3,700m	Yes until 12,140 ft 3,700m	Yes until 12,140 ft - 3,700m	Yes until 12,140 ft 3,700m	Yes until 12,140 ft 3,700m	Yes until 12,140 ft 3,700m	<b>Log book</b>	up to 90 dives (available during the dive)	up to 90 dives (available during the dive)		
<b>Log book</b>	50 dives by type	50 dives by type	50 dives by type	50 dives by type	50 dives by type	50 dives by type	70 h / 60 dives	<b>Sample rate</b>	off-0.5/1/2 sec	off-0.5/1/2 sec		
<b>Data acquisition frequency</b>	5 second (Air-Nitrox-Gauge) 2 second (Free ~60h)	5 second (Air-Nitrox-Gauge) 2 second (Free ~60h)	5 second (Air-Nitrox-Gauge) 2 second (Free ~60h)	5 second (Air-Nitrox-Gauge) 2 second - (Free)	5 second (Air-Nitrox-Gauge) 2 second (Free ~60h)	5 second (Air-Nitrox-Gauge) 2 second (Free ~60h)	20 seconds	<b>Temperature logbook acquisition</b>	Yes	No		
<b>Temperature logbook acquisition</b>	Yes	Yes	Yes	Yes	Yes	Yes	No	<b>Calendar</b>	Yes	Yes		
<b>Calendar</b>	Yes	Yes	Yes	Yes	Yes	Yes	Yes	<b>Alarm clock</b>	Yes	Yes		
<b>Alarm clock</b>	Yes	Yes	Yes	Yes	No	No	No	<b>Secondary time</b>	Yes	Yes		
<b>Secondary time</b>	Yes	Yes	Yes	Yes	No	No	No	<b>Stopwatch + Dualtimer</b>	Yes	Yes		
<b>Stopwatch</b>	Yes	Yes	Yes	Yes	No	No	No	<b>Battery type</b>	CR 2450 3V	CR 2450 3V		
<b>Battery type</b>	CR 2450 3V	CR 2450 3V	CR 2450 3V	CR 2450 3V	CR 2430 3V	CR 2430 3V	CR 2430 3V	<b>Estimate battery life</b>	4 years	4 years		
<b>Estimate battery life</b>	4 years	4 years	4 years	4 years	3+ years	3+ years	2 years	<b>User replaceable battery</b>	Yes	Yes		
<b>User replaceable battery</b>	Yes	Yes	Yes	Yes	Yes	Yes	Yes	<b>Sleep mode (battery safe)</b>	Yes	Yes		
<b>Dive planner</b>	Yes	Yes	Yes	Yes	Yes	Yes	Yes	<b>User replaceable watchband</b>	Yes	Yes		
<b>User replaceable watchband</b>	Yes	Yes	Yes	Yes	Yes	Yes	Yes	<b>Watchband extension</b>	Yes	Yes		
<b>Watchband extension</b>	Yes	Yes	Yes	Yes	No	No	No	<b>Unit system</b>	Metric · Imperial	Metric · Imperial		
<b>Unit system</b>	Metric · Imperial	Metric · Imperial	Metric · Imperial	Metric · Imperial	Metric · Imperial	Metric · Imperial	Metric · Imperial	<b>INTERFACE</b>	K5822001	K5822001		
<b>INTERFACE</b>	K5822001	K5822001	K5822001	K5822001	K5851000	K5851000	K5822001					

# WATCHES





# SEA LION LIMITED EDITION

## GOLD LABEL WATCH

- 25 JEWELS
- CORRECTOR
- EXCLUSIVE DEDICATED PACKAGING
- AUTOMATIC WINDING
- 28,800 VIBRATIONS PER HOUR

The Sea Lion is the first Cressi Gold Label limited edition product and identifies a lifestyle belonging to the brand. It is suitable for all water sports, but also for the daily life of water lovers. The watch, 100% Swiss Made, water-resistant to 300 metres, has a stainless steel case, a sapphire crystal front and a transparent sapphire crystal back. The 120-click unidirectional rotating bezel is graduated to 60 minutes with an anodised aluminium disc, to provide the diver with an accurate indication of dive

times. The self-winding mechanical movement is customized for Cressi Sub. The winding crown is at 16 o'clock, in steel with the Cressi brand engraved, in a functional position if wearing the wetsuit. Thus, the sturdy, comfortable and lightweight rubber strap allows precise adjustment of its length, so that it can be placed on the wrist above any sporting wear.



SILVER/BLUE



BLACK/BLACK



BLACK/ORANGE

### TECHNICAL FEATURES

<b>Case</b>	<ul style="list-style-type: none"> <li>• bearing design</li> <li>• transparent sapphire-glass back</li> <li>• winding crown</li> </ul>
<b>Diameter</b>	44 mm
<b>Material</b>	Steel
<b>Bezel</b>	<ul style="list-style-type: none"> <li>• unidirectional rotatable 60-minutes graduated</li> <li>• anti-scratch anodized aluminium</li> <li>• numerals and graduations engraved</li> </ul>
<b>Winding Crown</b>	Screw-down, at 16 o'clock
<b>Crystal</b>	Scratch-resistant sapphire
<b>Waterproof</b>	To 300 meters / 1,000 feet
<b>Movement</b>	<ul style="list-style-type: none"> <li>• automatic</li> <li>• mechanical</li> <li>• self-winding</li> </ul>
<b>Calibre</b>	Eta 2824-2
<b>Precision</b>	-2/+2 Sec./Day
<b>Functions</b>	<ul style="list-style-type: none"> <li>• Centre hour, minute and seconds hands</li> <li>• instantaneous date with rapid setting</li> <li>• stop-seconds for precise time setting</li> </ul>
<b>Winding</b>	Bidirectional self-winding
<b>Power Reserve</b>	Approximately 48 hours
<b>Strap</b>	Soft and comfortable with non-slip texture
<b>Material</b>	Black rubber
<b>Buckle</b>	Steel safety buckle
<b>Details</b>	Highly legible display with luminescent material



PRODUCT	CODE	DLR €	10%	SEASONAL ORDER 20%	RRP €
SEA LION WATCH 300m SILVER/BLUE	K5767020	374.99	337.49	299.99	619.99
SEA LION WATCH 300m BLACK/BLACK	K5767050	374.99	337.49	299.99	619.99
SEA LION WATCH 300m SILVER/ORANGE	K5767085	374.99	337.49	299.99	619.99
STRAP SEA LION WATCH BLACK	K5767100	24.99	22.49	19.99	39.99





# CONSOLES









# DIGI 2 SPECIALIZED Retailer-Product

RESIDUAL GAS AUTONOMY INDICATOR (IN MINUTES)

AUTOMATIC ACTIVATION WITH CONNECTION TO THE TANK

PRESSURE GAUGE + DEPTH GAUGE

## DIGITAL PRESSURE + DEPTH GAUGE

Designed for the harshest conditions, this extremely precise console is also easy to be used.



### TECHNICAL FEATURES

- Automatic activation with connection to the tank
- High contrast display
- Depth indicator 0-120 meters
- Tank pressure indicator 0-300 bar
- Water temperature indicator -10/+50 °C
- Residual gas autonomy in minutes indicator
- Gas reserve below 50 bar indicator
- Maximum depth of the last dive
- Autonomy up to 1000 hours in immersion
- Low battery indicator
- Self-diagnosis for battery change (patented)
- User-replaceable silicone protective shell
- Dimensions: 9.9 x 5.2 x 2.8 cm
- Weight: 122 gr

### SELF-DIAGNOSIS FOR BATTERY CHANGE (PATENTED)



PRODUCT	CODE	DLR €	10%	SEASONAL ORDER 20%	RRP €
DIGI2 DIGITAL CONSOLE BLUE	KC800020	137,49	123,74	109,99	248,75
DIGI2 DIGITAL CONSOLE WHITE	KC800030	137,49	123,74	109,99	248,75
DIGI2 DIGITAL CONSOLE PINK	KC800040	137,49	123,74	109,99	248,75
DIGI2 DIGITAL CONSOLE BLACK	KC800055	137,49	123,74	109,99	248,75
DIGI2 DIGITAL CONSOLE RED	JKC800058	137,49	123,74	109,99	248,75



# DIGI

## DIGITAL PRESSURE GAUGE

This very precise console is easy to use even in the most difficult conditions.

AUTOMATIC ACTIVATION WITH CONNECTION TO THE TANK

PRESSURE GAUGE

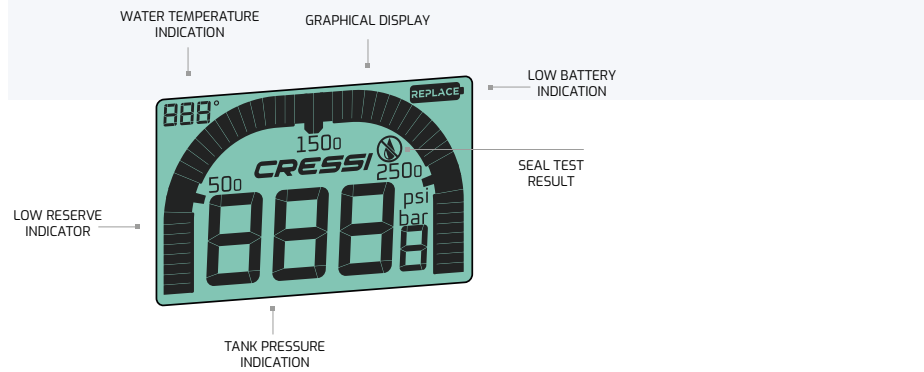

### TECHNICAL FEATURES

- Automatic activation with connection to the tank
- High contrast display
- Tank pressure indicator 0-300 bar
- Graphical display
- Water temperature indicator -10/+50°C
- Gas reserve below 50 bar indicator
- Autonomy up to 1000 hours in immersion
- Low battery indicator
- Self-diagnosis for battery change (patented)
- User-replaceable silicone protective shell
- Dimensions: 9.9 x 5.2 x 2.8 cm = 3.89 x 2.04 x 1.10 in
- Weight: 122 g = 4.30 oz

### SELF-DIAGNOSIS FOR BATTERY CHANGE (PATENTED)



PRODUCT	CODE	DLR €	10%	SEASONAL ORDER 20%	RRP €
DIGI DIGITAL PRESSURE GAUGE YELLOW BAR	KC790010	119,99	107,99	95,99	189,99



# CP2

## COMPASS + PRESSURE GAUGE

Compact and built to last, this console combines a Mini SPG and a compass. The textured boot is easy to handle, even while wearing gloves, and can be rigged with a clip or bungee and secured to the diver's BC for a streamlined profile in the water.

### TECHNICAL FEATURES

- Compass with rotating bezel for easy navigation
- Pressure gauge dial is color-coded in red, green and blue for instant readability.
- Reads pressures to 350 bar.
- Both instruments built with chrome-plated brass case for maximum durability.
- Compact rubber boot is textured for a sure grip.
- One connection loop, at the top side, for attaching a clip or bungee.
- Weight of console: 420 g (includes hose).

350 BAR / 5000 PSI  
PRESSURE READINGS | ROTATING BEZEL  
COMPASS



PRODUCT	CODE	DLR €	10%	SEASONAL ORDER 20%	RRP €
CONSOLE CP2 COMPASS+PRESSURE GAUGE BAR	KC764350	106,24	95,62	84,99	169,99

# PD2

## PRESSURE GAUGE + DEPTH GAUGE

Compact and built to last, this two-gauge console combines a Mini SPG and depth gauge. The textured boot is easy to handle, even while wearing gloves, and can be rigged with a clip or bungee and secured to the diver's BC for a streamlined profile in the water.

### TECHNICAL FEATURES

- Pressure gauge dial is color-coded in red, green and blue for instant readability.
- Reads pressures to 350 bar.
- Mini-depth gauge reads to 70 meters.
- Maximum depth indicator.
- Luminescent face on the depth gauge.
- Depth indications spaced out in first 12 meters (40 feet) for precise readings during safety stops.
- Both instruments built with chrome-plated brass case for maximum durability.
- Compact rubber boot is textured for a sure grip.
- One connection loop, at the top side, for attaching a clip or bungee.
- Weight of console: 420 g (includes hose).

350 BAR / 5000 PSI  
PRESSURE READINGS | 70 M DEPTH  
GAUGE



PRODUCT	CODE	DLR €	10%	SEASONAL ORDER 20%	RRP €
CONSOLE PD2 PRESSURE+DEPTH GAUGE M/BAR	KC764550	124,99	112,49	99,99	199,99

# CPD3

## COMPASS + PRESSURE GAUGE + DEPTH GAUGE

### TECHNICAL FEATURES

- Compass with rotating bezel for easy navigation
- Pressure gauge dial is color-coded in red, green and blue for instant readability.
- Reads pressures to 350 bar.
- Mini-depth gauge reads to 70 meters.
- Maximum depth indicator.
- Compact rubber boot is textured for a sure grip.
- One connection loop, at the top side, for attaching a clip or bungee.
- Weight of console: 420 g (includes hose)

350 BAR / 5000 PSI  
PRESSURE READINGS | ROTATING BEZEL  
COMPASS | 70 M DEPTH  
GAUGE



PRODUCT	CODE	DLR €	10%	SEASONAL ORDER 20%	RRP €
CONSOLE CPD3 COMPASS+PRESSURE+DEPTH GAUGE M/BAR	KC764460	149,99	134,99	119,99	239,99



# DP 2

## DEPTH GAUGE + PRESSURE GAUGE

Compact and built to last, this two-gauge console combines a Mini SPG and depth gauge. The textured boot is easy to handle, even while wearing gloves, and can be rigged with a clip or bungee and secured to the diver's BC for a streamlined profile in the water.

### TECHNICAL FEATURES

- Pressure gauge dial is color-coded in red, green and blue for instant readability.
- Reads pressures to 350 bar.
- Mini-depth gauge reads to 70 meters.
- Maximum depth indicator.
- Luminescent face on the depth gauge.
- Depth indications spaced out in first 12 meters for precise readings during safety stops.
- Both instruments built with chrome-plated brass case for maximum durability.
- Compact rubber boot is textured for a sure grip.
- Two connection loops, one on each side, for attaching a clip or bungee.
- Weight of console: 420 g (includes hose).

70 M DEPTH GAUGE

350 BAR / 5000 PSI PRESSURE READINGS



PRODUCT	CODE	DLR €	10%	SEASONAL ORDER 20%	RRP €
CONSOLE 2 DEPTH+PRESSURE GAUGE M/BAR	KC764250	99,99	89,99	79,99	159,99

# MINI SPG

## PRESSURE GAUGE

### TECHNICAL FEATURES

- Gauge dial is color-coded in red, green and blue for instant readability.
- Reads pressures to 350 bar or 5000 psi.
- Rugged mini-gauge has a chrome-plated brass case.
- Compact rubber boot is textured for a sure grip.
- Connection loop up-top is perfect for attaching a clip or bungee.

350 BAR / 5000 PSI PRESSURE READINGS



PRODUCT	CODE	DLR €	10%	SEASONAL ORDER 20%	RRP €
MINI SPG w/ RUBBER HOUSING (BAR)	KK760300	59,99	53,99	47,99	89,99
MINI SPG w/ RUBBER HOUSING (PSI)	KK760400	59,99	53,99	47,99	89,99

# COMPASS

## + STRAP AND BCD HOLDER

Robust and accurate compass for underwater navigation that ensures accuracy and durability for a long time. The compass perfect for travelers. Scratch-resistant and durable oil-filled polycarbonate case. Highly luminous dial for easy reference in low light conditions. Side view window for easy and accurate navigation.

NORTHERN AND SOUTHERN HEMISPHERES COMPATIBILITY

ROTATING BEZEL COMPASS



PRODUCT	CODE	DLR €	10%	SEASONAL ORDER 20%	RRP €
COMPASS + FIXING KIT	KB760100	53,13	47,82	42,50	84,99

## DIGI2 SMART COVER



CODE	DLR €	10%	SEASONAL ORDER 20%	RRP €
KZ790001	7,49	6,74	5,99	11,99

**DESCRIPTION:**  
Smart display cover for DIGI2 console  
**SUITABLE FOR:**  
DIGI2 Console

## DIGI CONSOLES COVERS



PRODUCT	CODE	DLR €	10%	SEASONAL ORDER 20%	RRP €
COVER DIGI2 BLACK	KZ790055	7,49	6,74	5,99	11,99
COVER DIGI2 BLUE	KZ790020	7,49	6,74	5,99	11,99
COVER DIGI2 WHITE	KZ790030	7,49	6,74	5,99	11,99
COVER DIGI2 PINK	KZ790040	7,49	6,74	5,99	11,99
COVER DIGI2 RED	KZ790058	7,49	6,74	5,99	11,99
COVER DIGI YELLOW	KZ791010	7,49	6,74	5,99	11,99

## BATTERY KIT DIGI2



CODE	DLR €	10%	SEASONAL ORDER 20%	RRP €
KZ790003	8,74	7,87	6,99	13,99

**DESCRIPTION:**  
Replacement battery CR2450 + O-Ring and rear cap kit  
**SUITABLE FOR:**  
DIGI2 Console  
DIGI Console

## HP HOSE



CODE	DLR €	10%	SEASONAL ORDER 20%	RRP €
KZ760501	31,88	28,69	25,50	50,99

**DESCRIPTION:**  
HP hose for pressure gauge, length: 81 cm / 32 inch

## MINI SPG + HOSE



CODE	DLR €	10%	SEASONAL ORDER 20%	RRP €
KZ760502	48,74	43,87	38,99	77,99

**DESCRIPTION:**  
Mini SPG + hose without rubber boot (BAR)

## DEPTH GAUGE MODULE



CODE	DLR €	10%	SEASONAL ORDER 20%	RRP €
KZ760504	41,88	37,69	33,50	66,99

**DESCRIPTION:**  
Mini-depth gauge module for console reads to 70 meters (230 feet)  
**SUITABLE FOR:**  
PD2 Console  
CPD3 Console  
Console 2

## COMPASS FOR CONSOLE 3



CODE	DLR €	10%	SEASONAL ORDER 20%	RRP €
KZ764199	26,24	23,62	20,99	41,99

**DESCRIPTION:**  
Spare compass module for console  
**SUITABLE FOR:**  
CP2 Console  
CPD3 Console  
Donatello 3 Console





# REGULATORS

1<sup>ST</sup> STAGE

T10 SC CROMO

2<sup>ND</sup> STAGE

GALAXY ADJUSTABLE

HIGH PERFORMANCE  
REGULATOR

CERTIFIED  
EN 250/2014  
FOR COLD WATERS

Very high performance regulator, same mechanics as the T10 Master. Ideal for seasoned or professional divers who need extremely high

performing equipment that is both simple and resistant, without any of the usual accessories that may get damaged.

Set (INT) + Hose tot. weight 1075 gr

Set (DIN) + Hose tot. weight 957 gr



Certification EN250/2014 for cold water

The T10-SEAL CHAMBER 1ST stage is environmentally sealed, protecting it against icing in cold water and against contamination from particulate matter in silty conditions.



T10-SC CROMO GALAXY-R  
INT REGULATOR



T10-SC CROMO GALAXY-R  
DIN REGULATOR

PRODUCT	CODE	DLR €	10%	SEASONAL ORDER 20%	RRP €
T10-SC CROMO/GALAXY R (INT) REGULATOR	HX890000	287.49	258.74	229.99	459.99
T10-SC CROMO/GALAXY R (DIN) REGULATOR	HX890100	287.49	258.74	229.99	459.99

RESULTS:

INHALE, EXHALE PRESSURE AND EXT WORK OF BREATHING

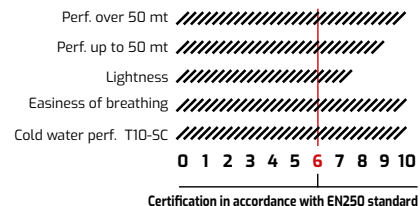
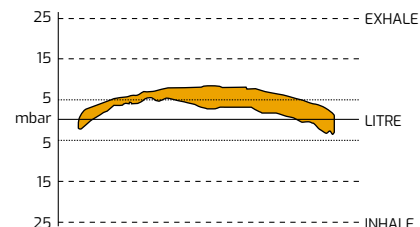

Certification in accordance with EN250 standard

TECHNICAL FEATURES 1ST STAGE

- Hyperbalanced diaphragm (Watertight chamber on T10-SC)
- 2 HP 7/16 UNF ports
- 4 MP 3/8 UNF ports
- Operating pressure: 300 bar (4350 psi) DIN Version, 232 bar (3365 psi) International version
- Calibration pressure: 10 bar
- High-capacity conical filter in chemically nickel-plated spherical bronze
- Removable nozzle in AISI 316 steel
- Hyperbalancing system
- Anti-pressure drop pneumatic spring
- Stainless steel calibration spring with micropeening treatment
- Low-friction technopolymer slider shaft
- Body protection in polyurethane thermoplastic
- Quantity of air supplied: 4500 l/min
- Weight, INT version: 720 gr
- Weight, DIN version: 602 gr

TECHNICAL FEATURES 2ND STAGE

- Pneumatically balanced
- Adjustable Venturi
- Adjustable inhalation effort
- Patented elliptical diaphragm
- Patented low-friction lever
- Air delivery system without injector
- Adjuster knob with dual OR
- Internal heat exchanger
- Cap opening with Cam-Lock
- Noise-absorbing technopolymer body
- Removable technopolymer deflector
- Removable mechanics
- Weight without hose: 202 gr

COMBINATION PERFORMANCE

- Average Cracking effort 3.5 mbar
- Average breathing effort 0.6 J/l

Jacketed hose extremely light and flexible weight: 153 gr

Certification EN250/2014 for cold water



ELITE CASE INCLUDED





# 1<sup>ST</sup> STAGE T10 SC PVD 2<sup>ND</sup> STAGE MASTER

PVD COATING TREATMENT

TITANIUM 2ND STAGE COVER

HIGH PERFORMANCE REGULATOR

CERTIFIED EN 250/2014 FOR COLD WATERS

Very high performance regulator. Ideal for seasoned or professional divers who need extremely high performing equipment that is both

simple and resistant, without any of the usual accessories that may get damaged.

Set (INT) + Hose tot. weight 1080 gr

Set (DIN) + Hose tot. weight 962 gr



T10-SC MASTER INT REGULATOR



T10-SC MASTER DIN REGULATOR



**Certification EN250/2014 for cold water**  
The T10-SEAL CHAMBER 1ST stage is environmentally sealed, protecting it against icing in cold water and against contamination from particulate matter in silty conditions.

**RESULTS:**  
INHALE, EXHALE PRESSURE AND EXT WORK OF BREATHING

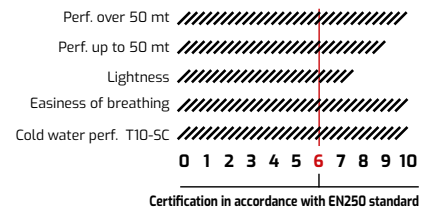
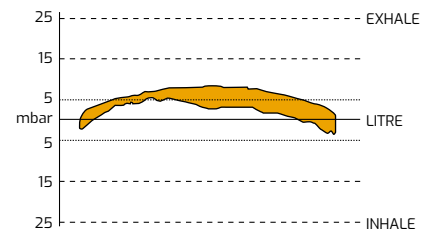

**TECHNICAL FEATURES 1ST STAGE**

- Hyperbalanced diaphragm (Watertight chamber on T10-SC)
- 2 HP 7/16 UNF ports
- 4 MP 3/8 UNF ports
- Operating pressure: 300 bar (4350 psi) DIN Version, 232 bar (3365 psi) International version
- Calibration pressure: 10 bar
- Body coated with PVD process
- High-capacity conical filter in chemically nickel-plated spherical bronze
- Removable nozzle in AISI 316 steel
- Hyperbalancing system
- Anti-pressure drop pneumatic spring
- Stainless steel calibration spring with micropeening treatment
- Low-friction technopolymer slider shaft
- Body protection in polyurethane thermoplastic
- Quantity of air supplied: 4500 l/min
- Weight, INT version: 720 gr
- Weight, DIN version: 602 gr

**TECHNICAL FEATURES 2ND STAGE**

- Pneumatically balanced
- Adjustable Venturi
- Adjustable inhalation effort
- Patented elliptical diaphragm
- Patented low-friction lever
- Air delivery system without injector
- Adjuster knob coated with PVD process with dual OR
- Laser-etched titanium front piece
- Internal heat exchanger
- Cap opening with Cam-Lock
- Noise-absorbing technopolymer body
- Removable technopolymer deflector
- Removable mechanics
- Weight without hose: 207 gr

**COMBINATION PERFORMANCE**

- Average Cracking effort 3.5 mbar
- Average breathing effort 0.6 J/l

**Jacketed hose extremely light and flexible weight: 153 gr**

**Certification EN250/2014 for cold waters**



ELITE CASE INCLUDED

PRODUCT	CODE	DLR €	10%	SEASONAL ORDER 20%	RRP €
T10-SC PVD / MASTER (INT) REGULATOR	HX830000	299,99	269,99	239,99	499,99
T10-SC PVD / MASTER (DIN 300) REGULATOR	HX830100	299,99	269,99	239,99	499,99





**SPECIALIZED**  
Retailer-Product



**MADE IN ITALY**

**1<sup>ST</sup> STAGE**

**T10 SC CROMO**

**2<sup>ND</sup> STAGE**

**MASTER CROMO**

Version technically identical to the T10 Master, but with a pleasing and durable satin chrome finish

on the first stage and a brushed stainless steel cap on the second stage.

Set (INT) + Hose tot. weight 1080 gr

Set (DIN) + Hose tot. weight 962 gr



**Certification EN250/2014 for cold water**

The T10-SEAL CHAMBER 1ST stage is environmentally sealed, protecting it against icing in cold water and against contamination from particulate matter in silty conditions. When paired with the Master second stage, which includes an internal heat exchanger, this regulator is an excellent choice for divers exploring the most extreme cold water environments.



T10-SC MASTER CROMO  
INT REGULATOR



T10-SC MASTER CROMO  
DIN REGULATOR

PRODUCT	CODE	DLR €	10%	SEASONAL ORDER 20%	RRP €
MASTER T10 SC CROMO REGULATOR INT	HX840000	274,99	247,49	219,99	445,99
MASTER T10 SC CROMO REGULATOR DIN	HX840100	274,99	247,49	219,99	445,99



HIGH PERFORMANCE  
REGULATOR

STAINLESS STEEL  
2ND STAGE COVER

CERTIFIED  
EN 250/2014  
FOR COLD WATERS

**RESULTS:**

INHALE, EXHALE PRESSURE AND EXT WORK OF BREATHING

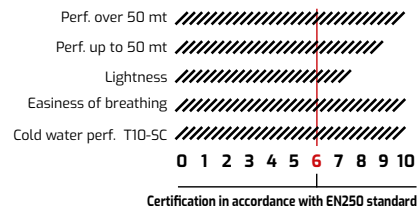
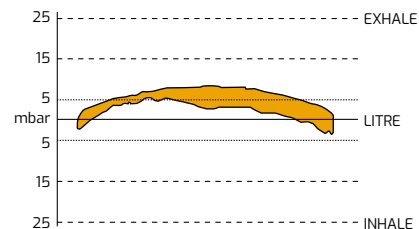

Certification in accordance with EN250 standard

**TECHNICAL FEATURES 1ST STAGE**

- Hyperbalanced diaphragm (Watertight chamber on T10-SC)
- 2 HP 7/16 UNF ports
- 4 MP 3/8 UNF ports
- Operating pressure: 300 bar (4350 psi) DIN Version, 232 bar (3365 psi) International version
- Calibration pressure: 10 bar
- High-capacity conical filter in chemically nickel-plated spherical bronze
- Removable nozzle in AISI 316 steel
- Hyperbalancing system
- Anti-pressure drop pneumatic spring
- Stainless steel calibration spring with micropeening treatment
- Low-friction technopolymer slider shaft
- Body protection in polyurethane thermoplastic
- Quantity of air supplied: 4500 l/min
- Weight, INT version: 720 gr
- Weight, DIN version: 602 gr

**TECHNICAL FEATURES 2ND STAGE**

- Pneumatically balanced
- Adjustable Venturi
- Adjustable inhalation effort
- Patented elliptical diaphragm
- Patented low-friction lever
- Air delivery system without injector
- Adjuster knob coated with PVD process with dual OR
- Internal heat exchanger
- Cap opening with Cam-lock
- Noise-absorbing technopolymer body
- Removable technopolymer deflector
- Removable mechanics
- Weight without hose: 207 gr

**COMBINATION PERFORMANCE**

- Average Cracking effort 3.5 mbar
- Average breathing effort 0.6 J/l

**Jacketed hose extremely light and flexible weight: 153 gr**

**Certification EN250/2014 for cold waters**



ELITE CASE INCLUDED



# 1<sup>ST</sup> STAGE AC25m 2<sup>ND</sup> STAGE MASTER CROMO

The AC25 is the third generation of Cressi's IP adjustable balanced piston first stage. It features 2 high-pressure ports and 5 low-pressure ports. 4 low-pressure ports are located on a rotating turret that ensures

that regulator and instrument connections are always in the right position. The fifth port is a co-axial Hi-Flow port and is located at the top of the turret.



The rotating turret swivels on 360° axis and features 5 low-pressure ports designed to allow the use of more connections without interfering between them. It features the external direct IP adjustment system that can be set using a simple Allen key. The hi-flow conic shape filter is the same for INT and DIN. The spring and the spring bush are coated preventing rust. Its technologically advanced design delivers consistent intermediate pressure and high performance even with low tank pressures. The AC25m it features a matte finish, in gun metal-coated brass. It is combined with the Master Cromo, the pneumatic balanced 2nd stage that features an elliptical shape and a lateral knob for Venturi adjustment.



AC25m MASTER CROMO  
INT REGULATOR



AC25m MASTER CROMO  
DIN REGULATOR

PRODUCT	CODE	DLR €	10%	SEASONAL ORDER 20%	RRP €
AC25m MASTER CHROME REGULATOR INT	HX900000	374.99	337.49	299.99	579.99
AC25m MASTER CHROME REGULATOR DIN	HX900100	374.99	337.49	299.99	579.99



**RESULTS:**  
INHALE, EXHALE PRESSURE AND EXT WORK OF BREATHING

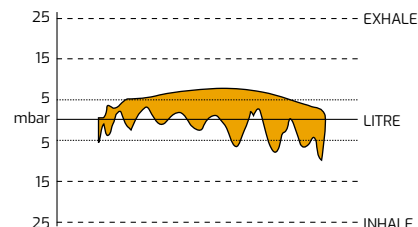

**TECHNICAL FEATURES 1ST STAGE**

- 3rd generation Cressi's IP adjustable balanced piston first stage
- 2x 7/16" HP ports UNF
- 5x 3/8" LP ports UNF, 1 port on turret top
- Operating pressure:
- INT version: 230 BAR | 3.336 PSI
- DIN version: 300 BAR | 4.351 PSI
- Calibration pressure: 9.8÷10 BAR | 142÷146 PSI
- 360° revolving head
- Realized in brass-coated, with a matte finish
- The sintered conical filter protects from any impurity
- External Direct IP adjustment system

**TECHNICAL FEATURES 2ND STAGE**

- Pneumatically balanced
- Adjustable Venturi
- Adjustable inhalation effort
- Patented elliptical diaphragm
- Patented low-friction lever
- Air delivery system without injector
- Adjuster knob coated with PVD process with dual OR
- Internal heat exchanger
- Cap opening with Cam-lock
- Noise-absorbing technopolymer body
- Removable technopolymer deflector
- Removable mechanics
- Weight without hose: 207 gr

**COMBINATION PERFORMANCE**

- Average breathing effort 0.78 J/l

**Jacketed hose extremely light and flexible weight: 153 gr**

**Certification EN250/2014 A>10° C**



ELITE CASE INCLUDED

# 1<sup>ST</sup> STAGE MC9 SC 2<sup>ND</sup> STAGE COMPACT PRO

In order to achieve extremely high performance in low temperature environments, the second stage in particular was designed with the special Thermoconductive Thermoplastic Neopolymer that has the capacity to transfer heat like a metal while preserving the design flexibility, chemical resistance, and physical and mechanical properties

of a conventional thermoplastic. That is, it makes it possible to drastically reduce the weight while delivering heat conductivity on a par with metal cases. Thanks to this material and a specially conceived purge valve, it passes EN 250 cold water tests.

Set (INT) + Hose tot. weight 943 gr

Set (DIN) + Hose tot. weight 803 gr



### Certification EN250/2014 for cold water

The MC9-SEAL CHAMBER 1ST stage is environmentally sealed, protecting it against icing in cold water and against contamination from particulate matter in silty conditions.



MC9 SC COMPACT PRO  
INT REGULATOR



MC9 SC COMPACT PRO  
DIN REGULATOR

RESULTS: INHALE, EXHALE PRESSURE AND EXT WORK OF BREATHING

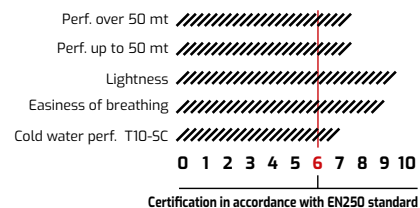
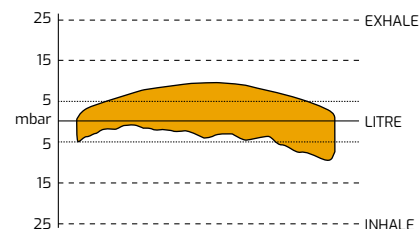

### TECHNICAL FEATURES 1ST STAGE

- Balanced diaphragm (seal chamber for MC9SC)
- 2 outlets HP 7/16 UNF
- 4 outlets MP 3/8 UNF
- Service pressure: 300 bar (4350 psi) DIN version, 232 bar (3365 psi) Yoke version
- Calibration pressure: 10 Bar
- Brass body Electroless Nickel plated
- High capacity conical filter electroless nickel plated
- Aisi 316 removable nozzle
- Hyper-balancing
- Anti-pressure drop pneumatic spring
- Setting spring: stainless steel with micropeening treatment
- Replaceable cylinder with anti-friction and anti-corrosion properties
- Elastomer protector
- Flow rate: 4500 l/min
- Yoke version weight: 650 gr
- Din version weight: 510 gr

### TECHNICAL FEATURES 2ND STAGE

- Improved reliability front cover (more impact resistant)
- Downstream system
- Adjustable Venturi effect
- Patented antifriction lever
- Thermoconductive technopolymer body
- Big purge button
- Anti-scratch surface
- Bayonet-type cap holder with security lock
- Removable exhaust tee
- Weight without hose: 140 gr

### COMBINATION PERFORMANCE

- Average Cracking effort 7.5 mbar
- Average breathing effort 1 J/l

Jacketed hose extremely light and flexible weight: 153 gr

Certification EN250/2014 for cold waters

PRODUCT	CODE	DLR €	10%	SEASONAL ORDER 20%	RRP €
MC9-SC /XS COMPACT PRO REGULATOR INT	HX782000	206.24	185.62	164.99	329.99
MC9-SC /XS COMPACT PRO REGULATOR DIN	HX782100	206.24	185.62	164.99	329.99



ELITE CASE INCLUDED



/ REGULATORS

1<sup>ST</sup> STAGE **MC9** 2<sup>ND</sup> STAGE **COMPACT**

LIGHTWEIGHT REGULATOR SETS CERTIFIED EN 250/2014

This premiere travel regulator packs maximum performance into minimum space. A true featherweight second stage, the Compact is built from lightweight techno-polymers to eliminate jaw

fatigue. Easy to pack and easy to dive, the Compact includes dive/pre-dive Venturi switch for managing freeflow and maximizing performance at depth.



MC9 COMPACT INT MC9 COMPACT DIN



MC9 COMPACT INT MC9 COMPACT DIN



MC9 COMPACT INT MC9 COMPACT DIN

RESULTS: INHALE, EXHALE PRESSURE AND EXT WORK OF BREATHING

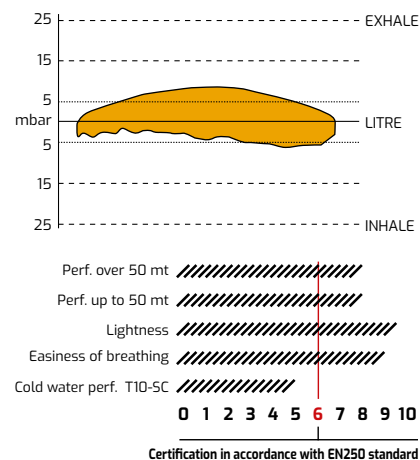

Set (INT) + Hose tot. weight	878 gr
Set (DIN) + Hose tot. weight	783 gr

TECHNICAL FEATURES 1ST STAGE

- Balanced diaphragm (seal chamber for MC95C)
- 2 outlets HP 7/16 UNF
- 4 outlets MP 3/8 UNF
- Service pressure: 300 bar (4350 psi) DIN version, 232 bar (3365 psi) Yoke version
- Calibration pressure: 10 Bar
- Brass body Electroless Nickel plated
- High capacity conical filter electroless nickel plated
- Aisi 316 removable nozzle
- Hyper-balancing
- Anti-pressure drop pneumatic spring
- Setting spring: stainless steel with micropeening treatment
- Replaceable cylinder with anti-friction and anti-corrosion properties
- Elastomer protector
- Flow rate: 4500 l/min
- Yoke version weight: 590 gr
- Din version weight: 450 gr

TECHNICAL FEATURES 2ND STAGE

- Downstream system
- Adjustable Venturi effect
- Patented antifriction lever
- Big purge button
- Anti-scratch surface
- Bayonet-type cap holder with security lock
- Removable exhaust tee without tools
- Weight without hose: 135 gr

COMBINATION PERFORMANCE

- Average Cracking effort 6 mbar
- Average breathing effort 1 J/L

Jacketed hose extremely light and flexible weight: 153 gr

Certification EN250/2014 A>10° C

PRODUCT	CODE	DLR €	10%	SEASONAL ORDER 20%	RRP €
MC9/XS COMPACT REGULATOR INT	HX783051	168,74	151,87	134,99	279,99
MC9/XS COMPACT REGULATOR DIN	HX784051	168,74	151,87	134,99	279,99
MC9/XS COMPACT REGULATOR INT BLUE	HX783020	168,74	151,87	134,99	279,99
MC9/XS COMPACT REGULATOR DIN BLUE	HX783021	168,74	151,87	134,99	279,99
MC9/XS COMPACT REGULATOR INT WHITE	HX783151	168,74	151,87	134,99	279,99
MC9/XS COMPACT REGULATOR DIN WHITE	HX784151	168,74	151,87	134,99	279,99

**1<sup>ST</sup> STAGE**  
**AC2**      **2<sup>ND</sup> STAGE**  
**COMPACT**



AC2 COMPACT INT

AC2 COMPACT DIN

PRODUCT	CODE	DLR €	10%	SEASONAL ORDER 20%	RRP €
AC2/COMPACT REGULATOR INT	HX787051	156.24	140.62	124.99	239.99
AC2/COMPACT REGULATOR DIN	HX788051	156.24	140.62	124.99	239.99

**TECHNICAL FEATURES 1ST STAGE**

- Unbalanced piston
- 1 outlets HP 7/16 UNF
- 4 outlets MP 3/8 UNF
- Service pressure: 300 bar (4350 psi) DIN version, 232 bar (3365 psi) Yoke version
- Calibration pressure: 9.5-10 Bar
- Brass body Electroless Nickel plated
- High capacity conical filter electroless nickel plated
- Aisi 316 long lasting piston
- Easy external direct IP adjustment system
- Stainless steel spring
- Flow rate: 2100 l/min
- Yoke version weight: 635 gr
- Din version weight: 495 gr

**TECHNICAL FEATURES 2ND STAGE**

- Downstream system
- Adjustable Venturi effect
- Patented antiriction lever
- Big purge button
- Anti-scratch surface
- Bayonet-type cap holder with security lock
- Removable exhaust tee without tools
- Weight without hose: 135 gr

**Jacketed hose extremely light and flexible weight: 153 gr**

**Certification EN250/2014 A>10° C**



DIRECT IP ADJUSTMENT SYSTEM (NO SHIMS REQUIRED)

**Set (INT) + Hose tot. weight** 923 gr

**Set (DIN) + Hose tot. weight** 783 gr

**1<sup>ST</sup> STAGE**  
**AC2**      **2<sup>ND</sup> STAGE**  
**XS2**



PRODUCT	CODE	DLR €	10%	SEASONAL ORDER 20%	RRP €
AC2/XS2 REGULATOR INT	HX780000	164.99	148.49	131.99	249.99

**TECHNICAL FEATURES 1ST STAGE**

- Unbalanced piston
- 1 outlets HP 7/16 UNF
- 4 outlets MP 3/8 UNF
- Service pressure: 232 bar (3365 psi) Yoke version
- Calibration pressure: 9.5-10 Bar
- Brass body Electroless Nickel plated
- High capacity conical filter electroless nickel plated
- Aisi 316 long lasting piston
- Easy external direct IP adjustment system
- Stainless steel spring
- Flow rate: 2100 l/min
- Yoke version weight: 635 gr

**TECHNICAL FEATURES 2ND STAGE**

- Downstream system
- Adjustable Venturi effect
- Easy maintenance
- Weight without hose: 206 gr

**Jacketed hose extremely light and flexible weight: 153 gr**

**Certification EN250/2014 A>10° C**



DIRECT IP ADJUSTMENT SYSTEM (NO SHIMS REQUIRED)

**Set (INT) + Hose tot. weight** 994 gr



**1<sup>ST</sup> STAGE**  
**AC2**

**2<sup>ND</sup> STAGE**  
**COMPACT**

**OCTOPUS**  
**COMPACT**

LIGHTWEIGHT  
REGULATOR SETS

CERTIFIED  
EN 250/2014



AC2 COMPACT INT



AC2 COMPACT DIN

**TECHNICAL FEATURES 1ST STAGE**

- Unbalanced piston
- 1 outlets HP 7/16 UNF
- 4 outlets MP 3/8 UNF
- Service pressure: 300 bar (4350 psi) DIN version, 232 bar (3365 psi) Yoke version
- Calibration pressure: 9.5-10 Bar
- Brass body Electroless Nickel plated
- High capacity conical filter electroless nickel plated
- Aisi 316 long lasting piston
- Easy external direct IP adjustment system
- Stainless steel spring
- Flow rate: 2100 l/min
- Yoke version weight: 635 gr
- Din version weight: 495 gr

**TECHNICAL FEATURES 2ND STAGE**

- Downstream system
- Adjustable Venturi effect
- Patented antifriction lever
- Big purge button
- Anti-scratch surface
- Bayonet-type cap holder with security lock
- Removable exhaust tee without tools
- Weight without hose: 135 gr

**Jacketed hose extremely light and flexible weight: 153 gr**

**Certification EN250/2014 A>10° C**



DIRECT IP ADJUSTMENT SYSTEM (NO SHIMS REQUIRED)

PRODUCT	CODE	DLR €	10%	SEASONAL ORDER 20%	RRP €
AC2 COMPACT+OCTOPUS COMPACT REGULATOR INT	HY787051	219,99	197,99	175,99	349,99
AC2 COMPACT+OCTOPUS COMPACT REGULATOR DIN	HY788051	219,99	197,99	175,99	349,99





# MG BALANCED



NATURAL AND EFFORTLESS BREATHING

PNEUMATICALLY BALANCED VALVE

CERTIFIED EN 250/2014 FOR COLD WATERS

## OCTOPUS

Octopus regulator specially designed for the most demanding divers. Its main feature is a pneumatically balanced valve that minimises the breathing effort. The Venturi effect adjuster on the mouthpiece tube increases and decreases the air flow, doing away with the risks associated with

free-flow. When scuba diving, breathing is natural and effortless. Thanks to its light weight and ergonomic design, this regulator is very handy and easy to use. Weight without the whip: 182 g.



### TECHNICAL FEATURES

- Pneumatically balanced
- Venturi effect adjustment
- Patented elliptical membrane
- Patented low-friction lever
- Air delivery system without injector
- Internal heat exchange
- Cam-lock system to open the case
- Body in noise-absorbent technopolymer
- Removable technopolymer deflector
- Removable mechanical parts
- Weight without whip: 182 gr

**Jacketed hose extremely light and flexible weight: 153 gr**

**Certification Annex B EN 250:2014 for cold water**

PRODUCT	CODE	DLR €	10%	SEASONAL ORDER 20%	RRP €
OCTOPUS MG BALANCED REGULATOR	HX880000	104,99	94,49	83,99	164,99

# COMPACT PRO

## OCTOPUS

An ideal second stage for use as a safe second, the Compact delivers big-regulator performance in a small, easily stowed package. It's unique shape make it easy to purge and deploy quickly.



QUICK AND EASY DEPLOYMENT

CERTIFIED EN 250/2014 FOR COLD WATERS



### TECHNICAL FEATURES

- Downstream system
- Adjustable Venturi effect
- Patented antifriction lever
- Thermoconductive technopolymer body
- Big purge button
- Anti-scratch surface
- Bayonet-type cap holder with security lock
- Removable exhaust tee without tools
- Weight without hose: 140 gr

**Jacketed hose extremely light and flexible weight: 153 gr**

**Certification Annex B EN 250:2014 for cold water**

PRODUCT	CODE	DLR €	10%	SEASONAL ORDER 20%	RRP €
OCTOPUS COMPACT PRO REGULATOR	HX789500	82,49	74,24	65,99	124,99



# COMPACT

## OCTOPUS

An ideal second stage for use as a safe second, the Compact delivers big-regulator performance in a small, easily stowed package. Its unique shape make it easy to purge and deploy quickly.



PRODUCT	CODE	DLR €	10%	SEASONAL ORDER 20%	RRP €
OCTOPUS COMPACT REGULATOR	HX789000	69,99	62,99	55,99	104,99

### TECHNICAL FEATURES

- Downstream system
- Adjustable Venturi effect
- Patented antifriction lever
- Big purge button
- Anti-scratch surface
- Bayonet-type cap holder with security lock
- Removable exhaust tee without tools
- Weight without hose :135 gr

**Jacketed hose extremely light and flexible weight: 153 gr**

**Certification Annex B EN 250:2014\_ A>10°C**

# XS

## OCTOPUS

Proven and highly affordable, the XS Octopus is ideal for any diver looking for maximum value. Its low maintenance and ultra reliable design also make it a favorite among dive schools and rental centers.



PRODUCT	CODE	DLR €	10%	SEASONAL ORDER 20%	RRP €
OCTOPUS XS REGULATOR	HX770098	77,49	69,74	61,99	121,78

### TECHNICAL FEATURES

- Downstream system
- Adjustable Venturi effect
- Easy maintenance
- Weight without hose: 206 gr

**Jacketed hose extremely light and flexible weight: 153 gr**

**Certification Annex B EN 250:2014\_ A>10°C**

/ REGULATORS

### T10 SC \*



VERSION	CODE	DLR €	10%	SEASONAL ORDER 20%	RRP €
INT	HZ991008	187,49	168,74	149,99	309,99
DIN	HZ991009	187,49	168,74	149,99	309,99

**DESCRIPTION:**  
Hyperbalanced T shape diaphragm 1st stage with seal chamber system, PVD finishing.

\*See compatibility warnings!

### T10 SC CROMO \*



VERSION	CODE	DLR €	10%	SEASONAL ORDER 20%	RRP €
INT	HZ991006	174,99	157,49	139,99	289,99
DIN	HZ991007	174,99	157,49	139,99	289,99

**DESCRIPTION:**  
Hyperbalanced T shape diaphragm 1st stage with seal chamber system, chrome finishing.

\*See compatibility warnings!

### AC25m \*



VERSION	CODE	DLR €	10%	SEASONAL ORDER 20%	RRP €
INT	HZ900003	219,99	197,99	175,99	349,99
DIN	HZ900004	219,99	197,99	175,99	349,99

**DESCRIPTION:**  
Revolving turret balanced piston 1st stage, gun-metal chrome finishing, external IP direct adjustment system.

\*See compatibility warnings!

### MC9 SC \*



VERSION	CODE	DLR €	10%	SEASONAL ORDER 20%	RRP €
INT	HZ820095	131,24	118,12	104,99	209,99
DIN	HZ820096	131,24	118,12	104,99	209,99

**DESCRIPTION:**  
Hyperbalanced in-line shape diaphragm 1st stage with seal chamber system.

\*See compatibility warnings!

### MC9 \*



VERSION	CODE	DLR €	10%	SEASONAL ORDER 20%	RRP €
INT	HZ820097	124,99	112,49	99,99	199,99
DIN	HZ820098	124,99	112,49	99,99	199,99

**DESCRIPTION:**  
Hyperbalanced in-line shape diaphragm 1st stage; external IP direct adjustment system.

\*See compatibility warnings!

### AC2 \*



VERSION	CODE	DLR €	10%	SEASONAL ORDER 20%	RRP €
INT	HZ991001	93,74	84,37	74,99	139,99
DIN	HZ780098	93,74	84,37	74,99	139,99

**DESCRIPTION:**  
Unbalanced piston 1st stage, external IP direct adjustment system.

\*See compatibility warnings!

### LONG SAFEFLEX HOSES \*



LENGHT	CODE	DLR €	10%	SEASONAL ORDER 20%	RRP €
150 CM	HZ730231	31,24	28,12	24,99	49,99
210 CM	HZ730232	43,74	39,37	34,99	69,99

**DESCRIPTION:**  
Replacement hoses for regulators

\*See compatibility warnings!

### \* COMPATIBILITY WARNINGS !

The 1st stages and hoses are sold ONLY as a replacement for the regulator combination for which its use is envisaged under the regulatory requirements in force. Therefore it may only be used as a replacement for the combination with second stages called for in the EC certificate for the type that concern it as well as the EC declaration of conformity for the product according to Regulation (EU) 2016/425, which can be viewed at [www.cressi.com](http://www.cressi.com). Cressi Sub declines all responsibility for any other use that does not conform with the requirements dictated by the regulations in force. The combinations of the certified Cressi regulators are contained in the last page of the Regulator user manual which can be read or downloaded from [www.cressi.com](http://www.cressi.com) using the following QR Code:

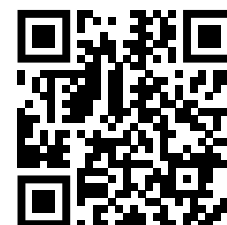



/ REGULATORS COMPARISON TABLE



1st STAGE	T10 SC CROMO	T10 SC PVD	T10 SC CROMO	AC25M	MC9 SC	MC9	AC2	AC2	
2nd STAGE	GALAXY ADJUSTABLE	MASTER	MASTER CROMO	MASTER CROMO	COMPACT PRO	COMPACT	COMPACT	XS2	
Set (INT) + Hose total weight	1075 gr	1080 gr	1080 gr	1170gr	943 gr	878 gr	923 gr	994 gr	
Set (DIN) + Hose total weight	957 gr	962 gr	962 gr	1054gr	803 gr	783 gr	783 gr	-	
CERTIFIED EN 250/2014	Cold Water (A)	Cold Water (A)	Cold Water (A)	Warm Water (A > 10°C)	Cold Water (A)	Warm Water (A > 10°C)	Warm Water (A > 10°C)	Warm Water (A > 10°C)	
<b>Technical Features 1st stage</b>									
Technology	"T" shape Hyperbalanced diaphragm 1st stage with Watertight "Seal chamber" system	"T" shape Hyperbalanced diaphragm 1st stage with Watertight "Seal chamber" system	"T" shape Hyperbalanced diaphragm 1st stage with Watertight "Seal chamber" system	3rd generation Cressi's Revolving Turret Balanced Piston first stage w/ direct IP external control system and 5th co-axial LP port	Hyperbalanced in-line diaphragm 1st stage with Watertight "Seal chamber" system	Hyperbalanced in-line diaphragm 1st stage	Unbalanced piston	Unbalanced piston	
PORTS	*2x HP 7/16 UNF 4x MP 3/8 UNF*	*2x HP 7/16 UNF 4x MP 3/8 UNF*	*2x HP 7/16 UNF 4x MP 3/8 UNF*	*2x HP 7/16 UNF 5x LP 3/8 UNF (1xCo-axial HI FLOW port on turret top)*	*2x HP 7/16 UNF 4x MP 3/8 UNF*	*2x HP 7/16 UNF 4x MP 3/8 UNF*	*1 HP 7/16 UNF 4 MP 3/8 UNF*	*1 HP 7/16 UNF 4 MP 3/8 UNF*	
MAX OPERATING PRESSURE	*DIN: 300 bar (4350 psi) INT: 232 bar (3365 psi)*	*DIN: 300 bar (4350 psi) INT: 232 bar (3365 psi)*	*DIN: 300 bar (4350 psi) INT: 232 bar (3365 psi)*	*DIN: 300 bar (4351 psi) INT: 230 bar (3336 psi)*	*DIN: 300 bar (4350 psi) INT: 232 bar (3365 psi)*	*DIN: 300 bar (4350 psi) INT: 232 bar (3365 psi)*	*DIN: 300 bar (4350 psi) INT: 232 bar (3365 psi)*	INT: 232 bar (3365 psi)	
IP CALIBRATION PRESSURE	9,5 -10 bar	9,5 -10 bar	9,5 -10 bar	9,5 -10 bar	9,5 -10 bar	9,5 -10 bar	9,5 -10 bar	9,5 -10 bar	
FILTER Design	High-capacity conical filter in chemically nickel-plated spherical bronze	High-capacity conical filter in chemically nickel-plated spherical bronze	High-capacity conical filter in chemically nickel-plated spherical bronze	High-capacity conical filter in chemically nickel-plated spherical bronze	High capacity conical filter electroless nickel plated	High capacity conical filter electroless nickel plated	High capacity conical filter electroless nickel plated	High capacity conical filter electroless nickel plated	
FLOW RATE	4500 l/min	4500 l/min	4500 l/min	3800l/min	4500 l/min	4500 l/min	2100 l/min	2100 l/min	
WEIGHT without Hose	*DIN: 602 gr INT: 720 gr*	*DIN: 602 gr INT: 720 gr*	*DIN: 602 gr INT: 720 gr*	*DIN: 694 gr INT: 814 gr*	*DIN: 510 gr INT: 650 gr*	*DIN: 450 gr INT: 590 gr*	*DIN: 495 gr INT: 635 gr*	INT: 635 gr	
1st stage Coating protection	Chemical Chromed Coating protection	Chemical Chromed Coating protection	Chemical Chromed Coating protection	"Gun Metal" Chemical Chromed Coating protection	Chemical Chromed Coating protectionw/ body Elastomer Protector	Chemical Chromed Coating protectionw/ body Elastomer Protector	Chemical Chromed Coating protection	Chemical Chromed Coating protection	
MAINTENANCE KITS	HZ800045 questo è quello del 1 stadio; manca quello del secondo	HZ800045 questo è quello del 1 stadio; manca quello del secondo	HZ800045 questo è quello del 1 stadio; manca quello del secondo	HZ850017 questo è quello del 1 stadio; manca quello del secondo	HZ800047 questo è quello del 1 stadio; manca quello del secondo	HZ800047 questo è quello del 1 stadio; manca quello del secondo	HZ730150 / HZ730149 questi sono quelli dei 1 stadi (specificare quale INT e quale DIN); manca quello del secondo	HZ730150questo è quello del 1 stadio; manca quello del secondo	
<b>Technical Features 2st stage</b>									
Tecnology	Pneumatically balanced	Pneumatically balanced	Pneumatically balanced	Pneumatically balanced	Standard Downstream	Standard Downstream	Standard Downstream	Standard Downstream	
ADJUSTABLE VENTURI Control System	Yes	Yes	Yes	Yes	Yes	Yes	Yes	Yes	
DIAPHRAGM Design	Patented Elliptical Diaphragm with co-molded Antifriction plate	Patented Elliptical Diaphragm with co-molded Antifriction plate	Patented Elliptical Diaphragm with co-molded Antifriction plate	Patented Elliptical Diaphragm with co-molded Antifriction plate	Circular with co-molded antifriction plate	Circular with co-molded antifriction plate	Circular with co-molded antifriction plate	Circular with metal plate	
LEVER Design	Ptented Reduced Friction Design Lever	Ptented Reduced Friction Design Lever	Ptented Reduced Friction Design Lever	Ptented Reduced Friction Design Lever	Ptented Reduced Friction Design Lever	Ptented Reduced Friction Design Lever	Ptented Reduced Friction Design Lever	Standard design	
HEATER EXCHANGER System	Internal Heater Exchanger System	Internal Heater Exchanger System	Internal Heater Exchanger System	Internal Heater Exchanger System	No	No	No	No	
WEIGHT without Hose	202 gr	207 gr	207 gr	207 gr	140 gr	135 gr	135 gr	206 gr	
<b>Combination Performance</b>									
EN 250 Average Cracking inhalation Effort	3.5 mbar	3.5 mbar	3.5 mbar	4,5 mbar	5 mbar	6 mbar	6 mbar	9mbar	
EN 250 WOB	0.6 J/l	0.6 J/l	0.6 J/l	0.7 J/l	1 J/l	1 J/l	1 J/l	1,5 J/l	
Elite Case Included	Yes	Yes	Yes	Yes	Yes	No	No	No	
Hose Included	Yes	Yes	Yes	Yes	Yes	Yes	Yes	Yes	
Hose Feature	Cressi Safeflex Jacketed hose extremely light and flexible	Cressi Safeflex Jacketed hose extremely light and flexible	Cressi Safeflex Jacketed hose extremely light and flexible	Cressi Safeflex Jacketed hose extremely light and flexible	Cressi Safeflex Jacketed hose extremely light and flexible	Thermoplastics Jacketed hose extremely light and flexible	Thermoplastics Jacketed hose extremely light and flexible	Thermoplastics Jacketed hose extremely light and flexible	
Hose Weight	153 g	153 g	153 g	153 g	153 g	153 g	153 g	153 g	

# TECHNICAL SCHEME POSTERS

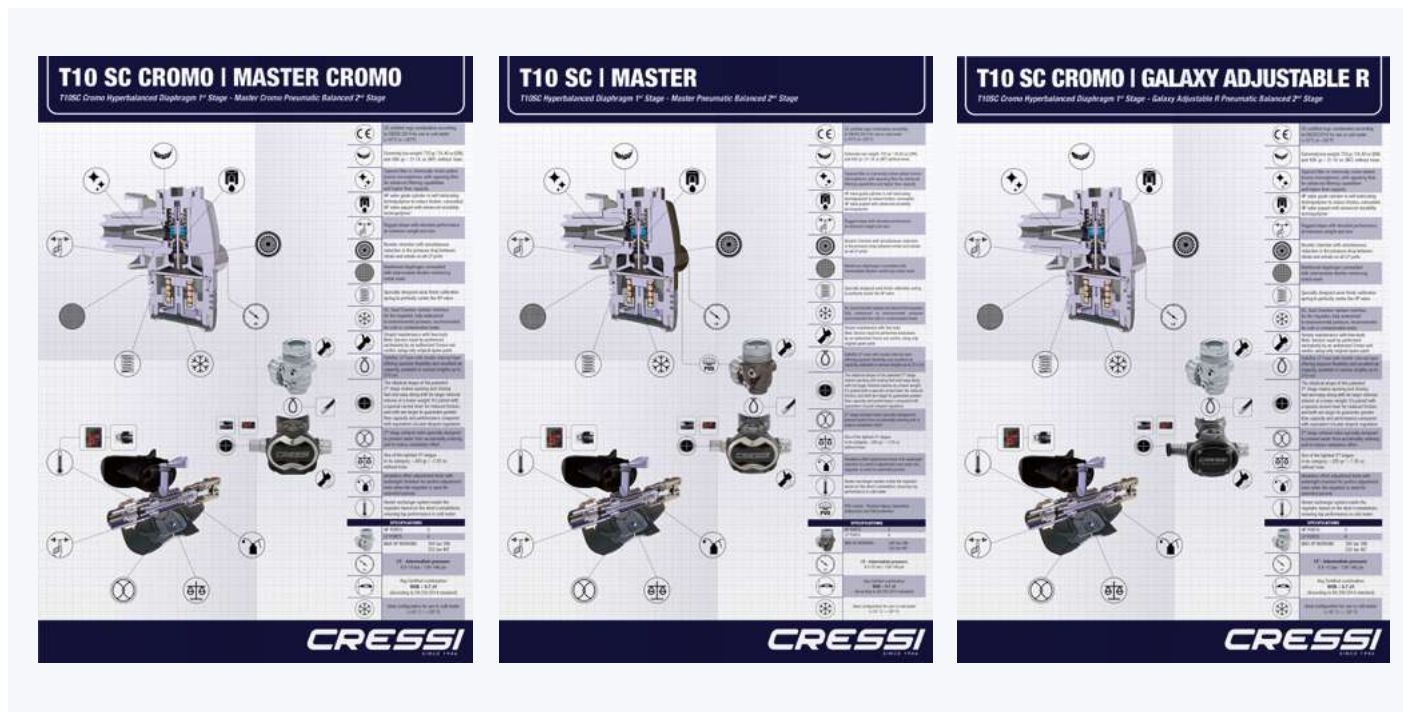

REGULATORS SPARE PARTS	CODE	DLR €	10%	SEASONAL ORDER 20%	RRP €
TECHNICAL DRAWING POSTER OF T10 SC CROMO MASTER CROMO	VPOSTERTMC	6.24	5.62	4.99	9.99
TECHNICAL DRAWING POSTER OF T10 SC MASTER	VPOSTERTM	6.24	5.62	4.99	9.99
TECHNICAL DRAWING POSTER OF T10 SC CROMO GALAXY ADJUSTABLE R	VPOSTERTGR	6.24	5.62	4.99	9.99

# MAIN REGULATORS SPARE PARTS

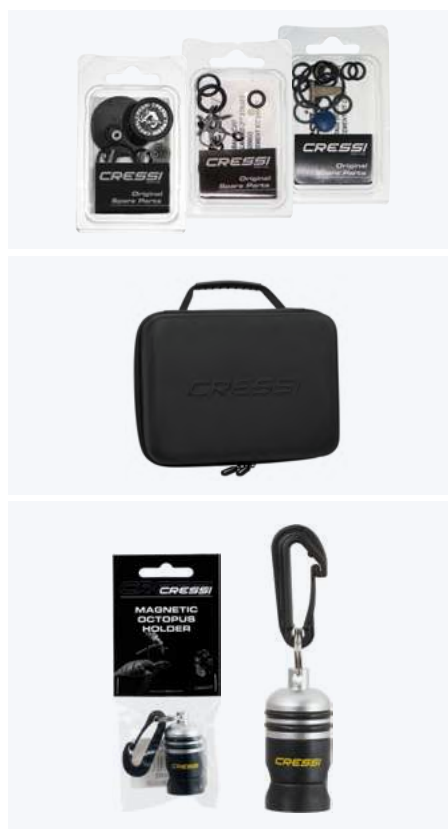

REGULATORS SPARE PARTS	CODE	DLR €	10%	SEASONAL ORDER 20%	RRP €
MAINTENANCE KIT 1st STAGE T10/T10SC CROMO INT/DIN	HZ800045	19.99	17.99	15.99	31.99
MAINTENANCE KIT 1st STAGE AC25M INT/DIN	HZ850017	21.88	19.69	17.50	34.99
MAINTENANCE KIT 1st STAGE MC9-MC9 SC-MC5-INT/DIN	HZ800047	18.74	16.87	14.99	29.99
MAINTENANCE KIT 1st STAGE AC10 INT	HZ735050	12.49	11.24	9.99	19.99
MAINTENANCE KIT 1st STAGE AC10 DIN 300	HZ735052	12.49	11.24	9.99	19.99
MAINTENANCE KIT 1st STAGE AC2 INT	HZ730150	8.74	7.87	6.99	13.99
MAINTENANCE KIT 1st STAGE AC2 DIN 300	HZ730149	8.74	7.87	6.99	13.99
MAINTENANCE KIT 2ND STAGE COMPACT	HZ780060	9.99	8.99	7.99	15.99
MAINTENANCE KIT 2nd STAGE MASTER/GAL/ELL.BAL/MG BAL.	HZ820080	12.49	11.24	9.99	19.99
MAINTEN.KIT 2NDSTAGE ELLIPSE TIT./STEEL/BLACK/OCTOPUS	HZ810067	11.24	10.12	8.99	17.99
MAINTENANCE KIT 2ND STAGE XS2/OCTOPUS	HZ790090	9.38	8.44	7.50	14.99
LP BLACK HOSE 80 cm	HZ730222	24.38	21.94	19.50	38.99
LP YELLOW HOSE 100 cm	HZ730225	27.49	24.74	21.99	43.99
COVER PURGE BUTTON BLACK	HZ780067	7.49	6.74	5.99	11.99
COVER PURGE BUTTON WHITE	HZ780064	7.49	6.74	5.99	11.99

REGULATORS TOOLS	CODE	DLR €	10%	SEASONAL ORDER 20%	RRP €
1st STAGE SETTING PRESSURE GAUGE	HZ710010	78.13	70.32	62.50	-
THREADED BAR TO TIGHTEN THE REGULATOR IN THE GRIP	HZ709008	15.63	14.07	12.50	-
PIN SPANNER	HZ739003	39.99	35.99	31.99	-

REGULATORS ACCESSORIES	CODE	DLR €	10%	SEASONAL ORDER 20%	RRP €
ELITE REGULATORS PROTECTIVE CASE	HZ700000	11.24	10.12	8.99	17.99
MAGNETIC OCTOPUS HOLDER	TA700002	21.24	19.12	16.99	34.99



## REGS SPECIFIC SERVICE COMPLETE KIT BAG



### REGULATORS TOOLS 1ST STAGE

- full set dynamometric wrench
- + 1st stage ip setting gauge
- + threaded bar to tighten the regulator in the vice
- + yoke nut removing socket and wrench
- + allen key 6 mm
- + allen key 7 mm
- + extraction pointtool
- + tool to remove o-rings
- + big compass s.c. spanner
- + antifreeze/s.c. spanner
- + push tool
- + ogival tool o-ring bullit
- + pin spanner
- + universal push tool
- + ac2 ip adjusting tool
- + removing hp seat ac2
- + pin punch 110 mm 2

### REGULATORS TOOLS 2ND STAGE

- 5,5 mm socket driver
- + spring push tool
- + allen key 4 mm
- + allen key 6 mm
- + o-ring removal tool
- + 2nd stage inline adjuster with ip gauge
- + 2nd stage setting gauge
- + small compass spanner
- + extraction plier

### JACKETS TOOLS

- 12 mm socket wrench
- + extraction point tool
- + compass spanner
- + allen key 2,5 mm
- + allen key 6 mm

PRODUCT	CODE	DLR €	10%	SEASONAL ORDER 20%	RRP €
SERVICE AND REPAIR COMPLETE KIT	HZ830102	1162,49	1046,24	929,99	-

## STANDARD TOOLS



CODE	DLR €	10%	SEASONAL ORDER 20%	RRP €
HZ710001	856,24	770,62	684,99	-

### DESCRIPTION:

Standard tools set for maintenance Cressi regulators

## DYNAMOMETRIC WRENCH



CODE	DLR €	10%	SEASONAL ORDER 20%	RRP €
HZ709021	706,24	635,62	564,99	-

### DESCRIPTION:

Dynamometric wrench + full set of accessories

## COMB. WRENCHES

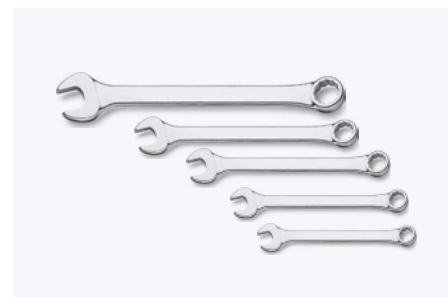

MM	CODE	DLR €	10%	SEASONAL ORDER 20%	RRP €
30	HZ709044	86,24	77,62	68,99	-
24	HZ709043	86,24	77,62	68,99	-
22	HZ709042	86,24	77,62	68,99	-
19	HZ709041	86,24	77,62	68,99	-
17	HZ709040	86,24	77,62	68,99	-

## MOBILE TEST BENCH



CODE	DLR €	10%	SEASONAL ORDER 20%	RRP €
HZ709030	1462,49	1316,24	1169,99	-

### DESCRIPTION:

Cressi regulator mobile test bench

## NEOPRENE PAD



CODE	DLR €	10%	SEASONAL ORDER 20%	RRP €
HZ710003	24,38	21,94	19,50	-

### DESCRIPTION:

Neoprene pad for regulators maintenance

## SPARE PARTS CATALOGUE



CODE	DLR €	10%	SEASONAL ORDER 20%	RRP €
VPPART00	19,38	17,44	15,50	-

### DESCRIPTION:

Service and repair operative manual



# B.C.D.'S



# COMMANDER EVOLUTION

HIGH LIFT CAPACITY | NYLON 420 D BACK CELL | FLAT LOCK AID WEIGHT SYSTEM

## HIGH VOLUME BACK INFLATION B.C.D.

The Commander Evolution Jacket is an impressively light high-buoyancy rear-mounted BC, anatomically designed for maximum comfort and wearability. Its main features are its detachable harness and air cell. The rear-mounted air cell interferes neither with the main underwater component nor the adjustment straps, not even when it is inflated to the maximum. This means extra freedom of movement and buoyancy for the diver. The special air cell compression strap guarantees extra quick deflation and volume control. The ultralight rigid back plate with its

integrated carrying handle ensures optimal stability. Its integrated Cressi Flat-Lock-Aid weight system makes it extra easy to release the pockets and rear ballast bags (attached to the tank-block band). Accessories include four 50mm shoulder aluminium D-rings and four 25mm aluminium D-rings (of which two on the pockets and two on the lower part of the harness). There are 3 pressure relief valves: one on the upper part of the hose, one reel-operated valve on the right-hand side of the shoulder and a third on the lower right-hand side of the air cell.

### TECHNICAL FEATURES

- Development of rear-mounted air cell
- Air cell material: 420 denier nylon
- Integrated Cressi Flat-lock Aid weight System
- 2 rear ballast pouches
- 3 pressure relief valves
- Four 50mm aluminium D-rings on the shoulder straps
- Four 25 mm stainless steel D-rings (2 on the pockets and 2 on the lower part of the harness)
- Ultralight rigid back plate with carrying handle
- Next generation anatomical inflator with hose retainer
- Multipurpose zip pockets
- 50 mm quick-release buckled shoulder straps

### BUOYANCY

SIZE	NEWTON	KG	POUNDS
XS	130	13.2	29.2
S	130	13.2	29.2
M	190	19.3	42.7
L	220	22.4	49.4
XL	220	22.4	49.4

### PRODUCT WEIGHT

SIZE	KG	LBS
XS	3.1	6.83
S	3.15	6.94
M	3.25	7.16
L	3.4	7.49
XL	3.45	7.6



PRODUCT	CODE	DLR €	10%	SEASONAL ORDER 20%	RRP €
COMMANDER EVOLUTION BCD XS	IC771000	393.74	354.37	314.99	599.99
COMMANDER EVOLUTION BCD S	IC771001	393.74	354.37	314.99	599.99
COMMANDER EVOLUTION BCD M	IC771002	393.74	354.37	314.99	599.99
COMMANDER EVOLUTION BCD L	IC771003	393.74	354.37	314.99	599.99
COMMANDER EVOLUTION BCD XL	IC771004	393.74	354.37	314.99	599.99



# CARBON ATELIER

offline product

NYLON 420 D  
BACK CELL

FLAT LOCK AID  
WEIGHT SYSTEM

## EXTREMELY VERSATILE B.C.D.

The Carbon jacket is a classically built BCD. Its intermediate buoyancy level makes it extremely versatile and suitable in any situation. The ergonomic design of the inflator mechanism makes inflating and deflating extra easy and the

practical hose retainer keeps it compact and safe. Its special ultralight back plate maintains the tank body compact which significantly improves both underwater and surface buoyancy and comfort.



### TECHNICAL FEATURES

- 420 denier nylon air cell
- Ultralight, rigid back plate with carrying handle.
- Next generation ergonomic inflator with hose retainer.
- 2 multipurpose zip pockets
- Rear ballast pockets.
- Shoulder straps with 50 mm quick-release buckles.
- 2 pressure relief valves

### BUOYANCY

SIZE	NEWTON	KG	POUNDS
XS	80	8,1	17,9
S	90	9,1	20,2
M	130	13,2	29,2
L	160	16,3	35,9
XL	190	19,3	42,7

### PRODUCT WEIGHT

SIZE	KG	LBS
XS	2,9	6,39
S	3	6,61
M	3,15	6,94
L	3,2	7,05
XL	3,3	7,27

PRODUCT	CODE	DLR €	10%	SEASONAL ORDER 20%	RRP €
CARBON BCD XS	IC741300	312,49	281,24	249,99	489,99
CARBON BCD S	IC741301	312,49	281,24	249,99	489,99
CARBON BCD M	IC741302	312,49	281,24	249,99	489,99
CARBON BCD L	IC741303	312,49	281,24	249,99	489,99
CARBON BCD XL	IC741304	312,49	281,24	249,99	489,99

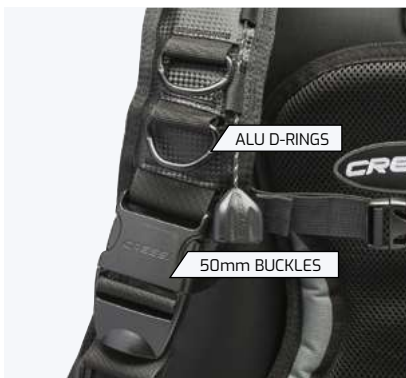



# SCORPION SPECIALIZED Retailer-Product

NYLON 420 D BACK CELL | FLAT LOCK AID WEIGHT SYSTEM

## ANATOMICAL BACK INFLATION B.C.D.

The Scorpion Jacket is an impressively light high-buoyancy rear-mounted BC, anatomically designed for maximum comfort and wearability. Its main features are its detachable harness and air cell. The rear-mounted air cell interferes neither with the main underwater component nor with the adjustment straps, not even when it is inflated to the maximum: this means extra freedom of

movement and buoyancy for the diver. The special air cell compression strap guarantees extra quick deflation and volume control. The ultralight semi-rigid harness ensures optimal stability and high comfort with its air-net fabric. Its integrated Cressi Flat-Lock-Aid Weight System makes extra easy to release the pockets.



### TECHNICAL FEATURES

- Development of rear-mounted air cell
- Air cell material: 420 denier nylon
- Integrated Cressi Flat-Lock-Aid Weight System on a back vertical position
- 2 pressure relief valves
- Two 50 mm aluminium D-rings on the shoulder straps
- Two 25 mm aluminium D-rings on the pockets
- Ultralight semi-rigid harness
- Next generation anatomical inflator with hose retainer
- Multipurpose zip pockets with weight pockets inside
- 40 mm quick-release buckled shoulder straps
- Side adjustable lumbar flaps

### BUOYANCY

SIZE	NEWTON	KG	POUNDS
XS	130	13,2	29,2
S	130	13,2	29,2
M	150	15,2	33,7
L	150	15,2	33,7
XL	150	15,2	33,7

### PRODUCT WEIGHT

SIZE	KG	LBS
XS	2,4	5,29
S	2,45	5,4
M	2,5	5,51
L	2,6	5,73
XL	2,65	5,84

PRODUCT	CODE	DLR €	10%	SEASONAL ORDER 20%	RRP €
SCORPION BCD XS	IC770000	312,49	281,24	249,99	479,99
SCORPION BCD S	IC770001	312,49	281,24	249,99	479,99
SCORPION BCD M	IC770002	312,49	281,24	249,99	479,99
SCORPION BCD L	IC770003	312,49	281,24	249,99	479,99
SCORPION BCD XL	IC770004	312,49	281,24	249,99	479,99





# AQUAWING

**SPECIALIZED**  
Retailer-Product

## ONE SIZE FITS ALL

Aquawing is the one-size donut jacket designed to adapt to all anatomies (male and female) using the new patented MAS (MAS (Modular Adjustment System): in fact, the single 50 mm belt that embraces the shoulders and waist can be rapidly adjusted to your size.

The shape of the air bladder has been designed to ensure perfect buoyancy with a monocylinder. The anodised light alloy back plate reduces the overall weight of the jacket while guaranteeing

stability and safety in use. The special cylinder rest in thermoplastic rubber integrated with the back of the jacket guarantees the positioning of the tank for optimum trim.

The shoulder straps and back cover are made with an air-net material to enhance comfort and improve water drainage.

The back cover is equipped with a special pocket designed to house the decompression buoy.

### TECHNICAL FEATURES

- One-size-fits-all (XS / XL)
- Air bladder: 210 D nylon
- Air bladder cover: 1500 D cordura
- MAS (Modular Adjustment System)
- 2 Stainless steel D-ring + 1 optional

### BUOYANCY

SIZE	NEWTON	KG	POUNDS
XS-XL	120	12.2	26.9

### PRODUCT WEIGHT

SIZE	KG	LBS
XS-XL	2.9	6.39



### PATENTED MODULAR ADJUSTMENT SYSTEM

The single belt that embraces the shoulders and waist can be rapidly adjusted



PRODUCT	CODE	DLR €	10%	SEASONAL ORDER 20%	RRP €
AQUAWING BCD XS/XL	IC790000	312.49	281.24	249.99	499.99
AQUAWING OPTIONAL D-RING	I2790000	21.24	19.12	16.99	33.99





# AQUAWING PLUS SPECIALIZED Retailer-Product

ANODISED LIGHT ALLOY BACK PLATE

NYLON 210 D AIR BLADDER

MODULAR ADJUSTMENT SYSTEM

EQUIPPED WITH WEIGHT POCKETS

## ONE SIZE FITS ALL + WEIGHT POCKETS

Aquawing Plus is the one-size donut jacket designed to adapt to all anatomies (male and female) using the new patented MAS (MAS (Modular Adjustment System): in fact, the single 50 mm belt that embraces the shoulders and waist can be rapidly adjusted to your size.

The shape of the air bladder has been designed to ensure perfect buoyancy with a monocylinder. The anodised light alloy back plate reduces the overall weight of the jacket while guaranteeing stability and safety in use. The special cylinder rest in thermoplastic rubber integrated with the back

of the jacket guarantees the positioning of the tank for optimum trim.

The shoulder straps and back cover are made with an air-net material to enhance comfort and improve water drainage.

The jacket is equipped with two weight pockets attached directly to the back plate in correspondence with your flanks.

The back cover is equipped with a special pocket designed to house the decompression buoy.

### TECHNICAL FEATURES

- One-size-fits-all (XS / XL)
- Air bladder: 210 D nylon
- Air bladder cover: 1500 D cordura
- MAS (Modular Adjustment System)
- 4 Stainless steel D-ring

### BUOYANCY

SIZE	NEWTON	KG	POUNDS
XS-XL	120	12.2	26.9

### PRODUCT WEIGHT

SIZE	KG	LBS
XS-XL	3.75	8.26



### PATENTED MODULAR ADJUSTMENT SYSTEM

The single belt that embraces the shoulders and waist can be rapidly adjusted



PRODUCT	CODE	DLR €	10%	SEASONAL ORDER 20%	RRP €
AQUAWING PLUS BCD XS/XL	IC79010	349,99	314,99	279,99	549,99



# PATROL

## ESSENTIAL BACK INFLATION B.C.D.

The Patrol BC is an impressively light weight, rear inflation BC that is anatomically designed for maximum comfort and durability. The special air cell compression strap guarantees extra quick deflation and volume control. The ultralight rigid back plate with its integrated carrying handle ensures optimal stability. The Patrol also features Cressi's Flat-Lock-Aid integrated weight system

that makes it easy to release the pockets. There are 3 pressure relief valves: one on the upper part of the hose, one valve on the right-hand side of the shoulder and a third on the lower right-hand side of the air cell. The Patrol also features plastic d-rings to help reduce weight and the shoulder and waist harness are fully adjustable to one full size up or down from the stated size.



### BUOYANCY

SIZE	NEWTON	KG	POUNDS
XS	130	13.2	29.2
S	130	13.2	29.2
M	190	19.3	42.7
L	220	22.4	49.4
XL	220	22.4	49.4

### PRODUCT WEIGHT

SIZE	KG	LBS
XS	2.6	5.73
S	2.6	5.73
M	2.75	6.06
L	2.9	6.39
XL	2.9	6.39



BACK WEIGHT POCKETS OPTIONAL



FLAT LOCK SYSTEM

PRODUCT	CODE	DLR €	10%	SEASONAL ORDER 20%	RRP €
PATROL BCD XS	IC741600	262.49	236.24	209.99	399.99
PATROL BCD S	IC741601	262.49	236.24	209.99	399.99
PATROL BCD M	IC741602	262.49	236.24	209.99	399.99
PATROL BCD L	IC741603	262.49	236.24	209.99	399.99
PATROL BCD XL	IC741604	262.49	236.24	209.99	399.99



40mm BUCKLES



FULLY ADJUSTABLE SHOULDER HARNESS



HIDEAWAY POCKET



FULLY ADJUSTABLE WAIST HARNESS



# AQUARIDE

## BUOYANCY CONTROL JACKET

NYLON 420 D  
STANDARD CELL

FLAT LOCK AID  
WEIGHT SYSTEM

Aquaride is a semi-classic structured BC with a special feature: it has adjustable shoulder straps that aren't restricted by the air cell, improving the grip on the tank and improving comfort. Thanks to their anatomical, preformed profile, they are much easier to put on and make resting the tank more comfortable on the shoulders.

The BC features the Flat type Lock Aid System of integrated weight. It is very effective and comfortable thanks to its extremely flat profile and the easy and intuitive arrangement of the pockets. Finally, the anatomical control has a hose retainer, making all inflation and deflation operations very easy and intuitive.



### TECHNICAL FEATURES

- 420 Denier Nylon bag.
- Flat system Lock Aid System integrated weight.
- Superlight rigid backpack with handle.
- Next generation anatomical inflator with hose retainer.
- Expandable sundries pocket with zip closure.
- Quick-attach rear weight pockets (capacity 2 kg).
- 2 overpressure valves.

### BUOYANCY

SIZE	NEWTON	KG	POUNDS
XS	80	8,1	17,9
S	90	9,1	20,2
M	130	13,2	29,2
L	160	16,3	35,9
XL	190	19,3	42,7

### PRODUCT WEIGHT

SIZE	KG	LBS
XS	3,0	6,61
S	3,1	6,83
M	3,2	7,05
L	3,3	7,27
XL	3,4	7,49

PRODUCT	CODE	DLR €	10%	SEASONAL ORDER 20%	RRP €
AQUARIDE BCD BLUE XS	IC740800	293,74	264,37	234,99	449,99
AQUARIDE BCD BLUE S	IC740801	293,74	264,37	234,99	449,99
AQUARIDE BCD BLUE M	IC740802	293,74	264,37	234,99	449,99
AQUARIDE BCD BLUE L	IC740803	293,74	264,37	234,99	449,99
AQUARIDE BCD BLUE XL	IC740804	293,74	264,37	234,99	449,99



FLAT LOCK SYSTEM



BACK WEIGHTS POCKETS



50mm BUCKLES



STEEL D-RINGS



ZIPPED POCKETS

# ELETTRA SPECIALIZED

DESIGNED FOR FEMALE ANATOMY

FLAT LOCK AID WEIGHT SYSTEM

## SPECIFICALLY DESIGNED FOR WOMEN

The Elettra jacket has been conceived to adapt to the female anatomy. The exclusive design and technical features provide perfect buoyancy with a close-fitting profile. The 40 mm buckles (shoulder-waist) adapt perfectly to the female anatomy. The lower band of the shoulder strap is anchored to a ring to ensure rotation and therefore maximum adaptability to the female anatomy. The internal part is fully lined with air-net material, with thicker padding to increase comfort and improve water

drainage. The two-piece waist band uses the new patented SPWB (Self Pivoting Waist Band) system. The soft and padded semi-rigid back plate permits the BCD to be folded and transported with the minimum possible volume. The Cressi Flat Lock integrated ballast system makes the extraction of the weight bags particularly easy. The jacket's two integrated cylinder supports improve the diver's trim.



### TECHNICAL FEATURES

- Female anatomy (SIZES: XS-S-M-L)
- Air bladder: nylon 420 D
- Pockets and shoulder straps: cordura 1500 D
- Self Pivoting Waist Band
- Integrated Cressi Flat-Lock Aid weight System
- 2 zip up pockets for accessories
- Semi-rigid harness
- 6 D-rings in stainless steel
- 2 overpressure valves



### BUOYANCY

SIZE	NEWTON	KG	POUNDS
XS	100	10,1	22,4
S	100	10,1	22,4
M	140	14,2	31,4
L	160	16,3	35,9

### PRODUCT WEIGHT

SIZE	KG	LBS
XS	2,95	6,5
S	3	6,61
M	3,1	6,83
L	3,15	6,94

PRODUCT	CODE	DLR €	10%	SEASONAL ORDER 20%	RRP €
ELETTRA BCD XS	IC774001	349,99	314,99	279,99	529,99
ELETTRA BCD S	IC774002	349,99	314,99	279,99	529,99
ELETTRA BCD M	IC774003	349,99	314,99	279,99	529,99
ELETTRA BCD L	IC774004	349,99	314,99	279,99	529,99





# AVIATOR

## EASY ADJUSTABLE TRAVEL B.C.D.

Aviator is a B.C. with a classic structure designed for travel. The 50 mm buckle of the shoulder strap is pivoting according to a new Cressi patent, to guarantee perfect adaptability to all body shapes. The modular system of the abdominal band, with exclusive Cressi design, offers the possibility to quickly change the band itself – divided into two parts – to adapt to different sizes. The adjustable mechanical pivot system and the presence of an elastic band in the two parts of the band guarantee

superior comfort. The semi-rigid, soft and padded back allows you to fold and carry the B. C. in the smallest possible space. The special air-net material in the shoulder straps and back ensures greater comfort and water drainage. The Integrated Cressi Flat-Lock Aid weight System makes it very easy to remove the lead pockets. Two supports, that are integrated in the B.C. for fixing the tank, improve the diver trim.



### TECHNICAL FEATURES

- 420 denier nylon material
- Self pivoting waist band
- New 50 mm pivoting shoulder strap buckle
- Rubbery material (rear)
- Integrated Cressi Flat-Lock Aid weight System
- 2 zip up pockets for accessories
- 2 rear weight carrying pockets
- Semi-rigid harness
- D-rings and rings in light alloy
- 2 overpressure valves
- Rear release valve with control brought to the front

### BUOYANCY

SIZE	NEWTON	KG	POUNDS
XS	60	6,1	13,4
S	80	8,1	17,9
M	90	9,1	20,2
L	130	13,2	29,2
XL	160	16,3	35,9

### PRODUCT WEIGHT

SIZE	KG	LBS
XS	2,5	5,51
S	2,5	5,51
M	2,6	5,73
L	2,6	5,73
XL	2,7	5,95

PRODUCT	CODE	DLR €	10%	SEASONAL ORDER 20%	RRP €
AVIATOR BCD XS	IC772000	349,99	314,99	279,99	529,99
AVIATOR BCD S	IC772001	349,99	314,99	279,99	529,99
AVIATOR BCD M	IC772002	349,99	314,99	279,99	529,99
AVIATOR BCD L	IC772003	349,99	314,99	279,99	529,99
AVIATOR BCD XL	IC772004	349,99	314,99	279,99	529,99

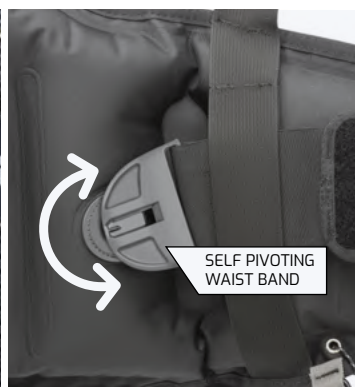

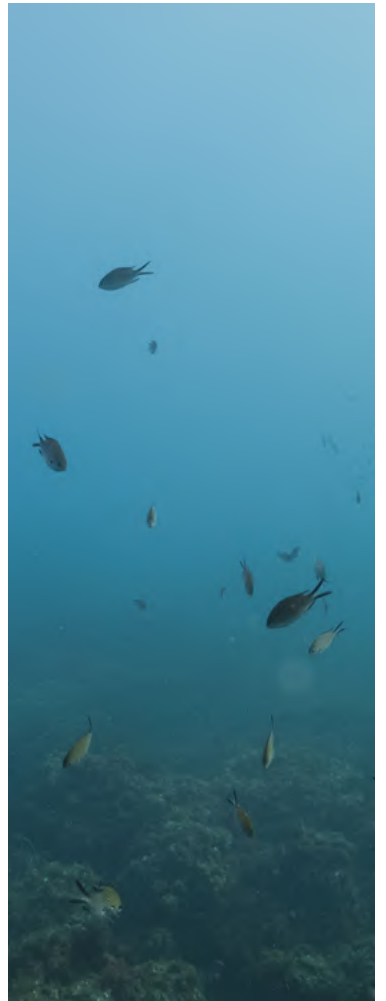
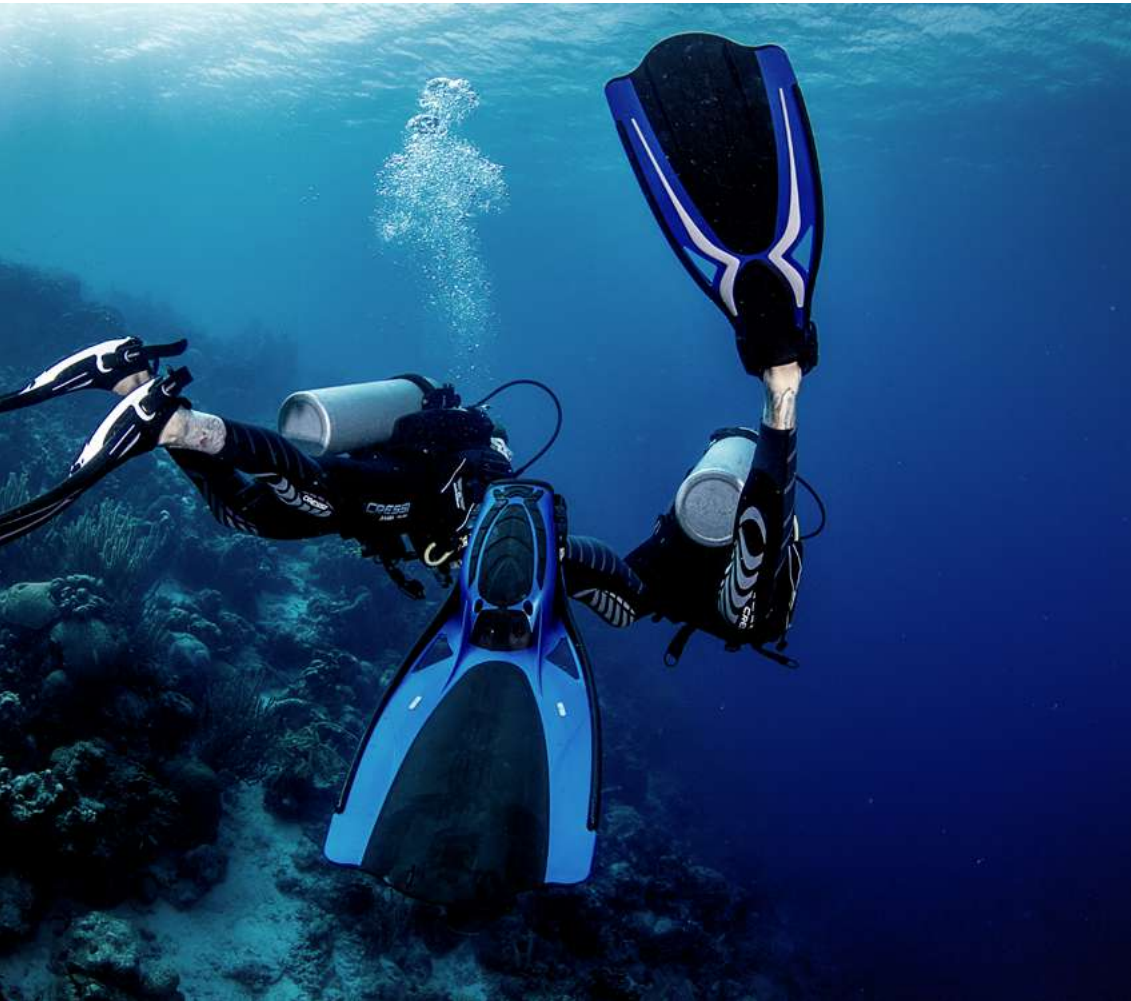

Photo by: Chiara Salomoni & By Kayle





igh Burns, Cam Grant



# TRAVELIGHT

## TRAVEL B.C.D.

This combination of lightness, flexibility and equipment make this model a perfect option not only for diving travels but also for divers who value

comfort, hydrodynamics and freedom sensation of light and simple jackets.



BLUE

PINK

### TECHNICAL FEATURES

- 210 denier nylon material, rubbery material (rear)
- 2 zip up pockets for accessories
- 2 rear weight carrying pockets
- Soft, padded back, with double strap for fixing the tank
- D-rings and rings in light alloy.
- 2 overpressure valves
- Rear release valve with control brought to the front
- FAST system for folding and compacting the BC
- Velcro strap, closed in a lower zip up pocket for packing the BC.

### BUOYANCY

SIZE	NEWTON	KG	POUNDS
XS	60	6,1	13,4
S	80	8,1	17,9
M	90	9,1	20,2
L	130	13,2	29,2
XL	160	16,3	35,9

### PRODUCT WEIGHT

SIZE	KG	LBS
XS	2,4	5,29
S	2,4	5,29
M	2,5	5,51
L	2,5	5,51
XL	2,6	5,73

PRODUCT	CODE	DLR €	10%	SEASONAL ORDER 20%	RRP €
TRAVELIGHT BCD BLUE XS	IC740600	318,74	286,87	254,99	459,99
TRAVELIGHT BCD BLUE S	IC740601	318,74	286,87	254,99	459,99
TRAVELIGHT BCD BLUE M	IC740602	318,74	286,87	254,99	459,99
TRAVELIGHT BCD BLUE L	IC740603	318,74	286,87	254,99	459,99
TRAVELIGHT BCD BLUE XL	IC740604	318,74	286,87	254,99	459,99
TRAVELIGHT LADY BCD PINK XS	IC740620	318,74	286,87	254,99	459,99
TRAVELIGHT LADY BCD PINK S	IC740621	318,74	286,87	254,99	459,99
TRAVELIGHT LADY BCD PINK M	IC740622	318,74	286,87	254,99	459,99



FLAT LOCK SYSTEM



FAST FOLDING SYSTEM



LIGHT ALLOY D-RINGS

40mm BUCKLES



ZIPPED POCKETS



# START PRO

## ROBUST WEIGHT POCKET INTEGRATED B.C.D.

Its high level of buoyancy (notably in the smaller models) makes this jacket ideal for beginners, diving schools or renting.



HIGH LIFT CAPACITY | CORDURA 500 D STANDARD CELL | FIXED GRAVITY POCKETS

### TECHNICAL FEATURES

- 500 denier cordura (exterior) and 420 denier nylon (interior)
- External ballast-carrying pockets with quick-release safety buckle
- 2 very big multipurpose zip pockets
- ultralight rigid backplate with carrying handle.
- 2 pressure relief valves.
- Four 40 mm engineering plastic D-rings (2 on the shoulder straps and 2 on the lower part of the air cell).
- Two 25mm engineering plastic D-rings on the pockets.
- Size indicated clearly on the shoulder strap.
- Shoulder straps with 50mm buckles.

### BUOYANCY

SIZE	NEWTON	KG	POUNDS
XXS	70	7,1	15,7
XS	130	13,2	29,2
S	140	14,2	31,4
M	150	15,2	33,7
L	170	17,3	38,2
XL	200	20,3	44,9
XXL	200	20,3	44,9

### PRODUCT WEIGHT

SIZE	KG	LBS
XXS	2,4	5,29
XS	2,5	5,51
S	2,5	5,51
M	2,75	6,06
L	2,8	6,17
XL	2,9	6,39
XXL	2,9	6,39

PRODUCT	CODE	DLR €	10%	SEASONAL ORDER 20%	RRP €
START PRO BCD 2XS	IC721905	249,99	224,99	199,99	369,99
START PRO BCD XS	IC721900	249,99	224,99	199,99	369,99
START PRO BCD S	IC721901	249,99	224,99	199,99	369,99
START PRO BCD M	IC721902	249,99	224,99	199,99	369,99
START PRO BCD L	IC721903	249,99	224,99	199,99	369,99
START PRO BCD XL	IC721904	249,99	224,99	199,99	369,99
START PRO BCD 2XL	IC721906	249,99	224,99	199,99	369,99

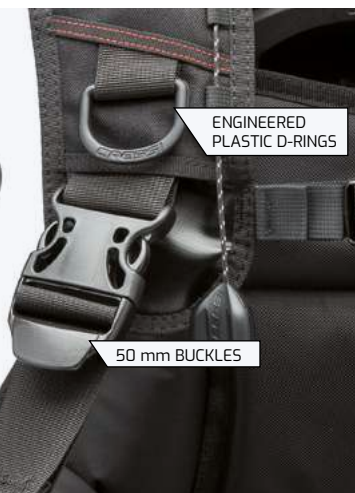
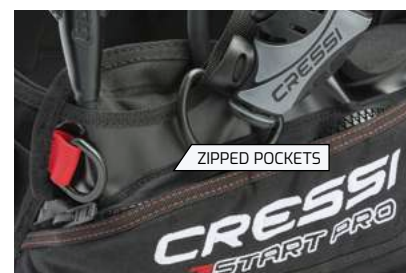

# START

## ROBUST B.C.D.

Simple, robust and efficient jacket designed for diving centers' needs and for professional work

companies that want a reliable product, of great resistance and with affordable price.



### TECHNICAL FEATURES

- It has a sack that combines Cordura® 1000 Deniers on the outside, pockets and shoulder pads, and 500 Deniers on the inside part.
- Manometer and octopus fixation integrated system, really useful especially for diving centers.
- High-capacity pockets with closing by Velcro and a wide lapel.
- Abdominal strap separated from the sack to eliminate the oppression during the inflation.
- Chest strap.
- Very light and resistant semi rigid back pack.
- Size visible on the right shoulder pad.
- Small pocket over the shoulder pad that allows introducing in the octopus' hose folded.
- Direct System with double air filtering system easily removable in case of emergency cleaning.
- Extraordinary relationship size / ascensional capacity thanks to its new pattern and to the spacers installed inside the sack: T/XS 13.3 kg; T/S 14.3 kg; T/M 15.3 kg; T/L 17.3 kg; T/XL 20.4 kg.

### BUOYANCY

SIZE	NEWTON	KG	POUNDS
XS	130	13.2	29.2
S	140	14.2	31.4
M	150	15.2	33.7
L	170	17.3	38.2
XL	200	20.3	44.9

### PRODUCT WEIGHT

SIZE	KG	LBS
XS	2.4	5.29
S	2.5	5.51
M	2.6	5.73
L	2.7	5.95
XL	2.8	6.17

PRODUCT	CODE	DLR €	10%	SEASONAL ORDER 20%	RRP €
START BCD XS	IC721700	218.74	196.87	174.99	324.99
START BCD S	IC721701	218.74	196.87	174.99	324.99
START BCD M	IC721702	218.74	196.87	174.99	324.99
START BCD L	IC721703	218.74	196.87	174.99	324.99
START BCD XL	IC721704	218.74	196.87	174.99	324.99



GAUGE AND OCTOPUS HOLDER



OCTOPUS HOLDER



SIZE ON SHOULDER PAD



COMPACT TANK BACKPACK



# QUARTZ

## DESIGNED FOR DIVE CENTERS

Quartz, that has a good buoyancy, is the ideal B.C. for scuba diving schools and equipment rental centres. The Integrated Cressi Flat-Lock Aid weight System makes it very easy to remove the lead pockets. It features a coloured reinforcement

band in the upper part of the back, at neck level, to enhance visibility in the water and protect the jacket from the abrasive action of the first stage. The sternal attachment is closed by a buckle, which also serves as a safety whistle.

HIGH LIFT CAPACITY | CORDURA 500 D STANDARD CELL | FLAT LOCK AID WEIGHT SYSTEM

### TECHNICAL FEATURES

- 500 denier Cordura material (exterior and interior part)
- Integrated Cressi Flat-Lock Aid weight System
- 2 large accessory holder zip-up pockets
- Light-weight, rigid backplate with carry handle
- 2 overpressure dump valves
- 2 25 mm technopolymer D-rings on the pockets
- Size shown on shoulder straps
- 50 mm shoulder straps with buckles.

### BUOYANCY

SIZE	NEWTON	KG	POUNDS
XS	120	12.2	26.9
S	140	14.2	31.4
M	160	16.3	35.9
L	190	19.3	42.7
XL	220	22.4	49.4

### PRODUCT WEIGHT

SIZE	KG	LBS
XS	2.6	5.73
S	2.7	5.95
M	2.9	6.39
L	2.9	6.39
XL	2.93	6.46



PRODUCT	CODE	DLR €	10%	SEASONAL ORDER 20%	RRP €
QUARTZ BCD DIVE CENTER EDITION XS	JIC741900	262.49	236.24	209.99	389.99
QUARTZ BCD DIVE CENTER EDITION S	JIC741901	262.49	236.24	209.99	389.99
QUARTZ BCD DIVE CENTER EDITION M	JIC741902	262.49	236.24	209.99	389.99
QUARTZ BCD DIVE CENTER EDITION L	JIC741903	262.49	236.24	209.99	389.99
QUARTZ BCD DIVE CENTER EDITION XL	JIC741904	262.49	236.24	209.99	389.99



# SOLID

## DESIGNED FOR DIVE CENTERS

Jacket Solid: Good buoyancy, ideal for scuba diving schools and equipment rental centres. It features a coloured reinforcement band in the upper part of the back, at neck level, to enhance visibility in

the water and protect the jacket from the abrasive action of the first stage. The sternal attachment is closed by a buckle which also serves as a safety whistle.



### TECHNICAL FEATURES

- 500D Cordura (exterior part) and 420D Nylon (interior)
- 2 large accessory holder zip-up pockets
- Light-weight, rigid backplate with carry handle.
- 2 overpressure dump valves
- 2 25 mm technopolymer D-rings on the pockets
- Size shown on shoulder straps
- 50 mm shoulder straps with buckles.

### BUOYANCY

SIZE	NEWTON	KG	POUNDS
XXS	80	8,1	17,9
XS	120	12,2	26,9
S	140	14,2	31,4
M	160	16,3	35,9
L	190	19,3	42,7
XL	220	22,4	49,4
XXL	n/a	n/a	n/a

### PRODUCT WEIGHT

SIZE	KG	LBS
XXS	2,1	4,63
XS	2,2	4,85
S	2,25	4,96
M	2,3	5,07
L	2,35	5,18
XL	2,4	5,29
XXL	n/a	n/a

PRODUCT	CODE	DLR €	10%	SEASONAL ORDER 20%	RRP €
SOLID BCD DIVE CENTER EDITION 2XS	JIC741705	212,49	191,24	169,99	319,99
SOLID BCD DIVE CENTER EDITION XS	JIC741700	212,49	191,24	169,99	319,99
SOLID BCD DIVE CENTER EDITION S	JIC741701	212,49	191,24	169,99	319,99
SOLID BCD DIVE CENTER EDITION M	JIC741702	212,49	191,24	169,99	319,99
SOLID BCD DIVE CENTER EDITION L	JIC741703	212,49	191,24	169,99	319,99
SOLID BCD DIVE CENTER EDITION XL	JIC741704	212,49	191,24	169,99	319,99
SOLID BCD DIVE CENTER EDITION 2XL	JIC741706	212,49	191,24	169,99	319,99



GAUGE AND OCTOPUS HOLDER



HIGH VISIBILITY BACK PAD



50mm BUCKLES



ZIPPED POCKETS



ULTRA RESISTANT MATERIALS



# START PRO SCUBA SET

A READY TO USE SET  
TO START SCUBA DIVING

CONVENIENT AND  
QUALITY EQUIPMENT

A COMPLETE SCUBA SET INCLUDING:  
B.C.D. Start Pro  
1st Stage MC9  
2nd Stage Compact  
Octopus Compact  
Console 2



PRODUCT	CODE	DLR €	10%	SEASONAL ORDER 20%	RRP €
START PRO SCUBA SET/INT XS	IY721800	568.74	511.87	454.99	799.99
START PRO SCUBA SET/INT S	IY721801	568.74	511.87	454.99	799.99
START PRO SCUBA SET/INT M	IY721802	568.74	511.87	454.99	799.99
START PRO SCUBA SET/INT L	IY721803	568.74	511.87	454.99	799.99
START PRO SCUBA SET/INT XL	IY721804	568.74	511.87	454.99	799.99
START PRO SCUBA SET/DIN XS	IY721810	568.74	511.87	454.99	799.99
START PRO SCUBA SET/DIN S	IY721811	568.74	511.87	454.99	799.99
START PRO SCUBA SET/DIN M	IY721812	568.74	511.87	454.99	799.99
START PRO SCUBA SET/DIN L	IY721813	568.74	511.87	454.99	799.99
START PRO SCUBA SET/DIN XL	IY721814	568.74	511.87	454.99	799.99

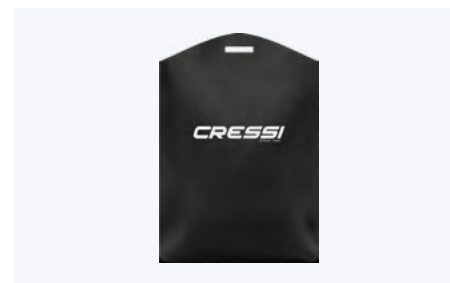

# START SCUBA SET

A COMPLETE SCUBA SET INCLUDING:  
B.C.D. Start  
1st stage AC2  
2nd stage compact  
Octopus compact  
Pressure Gauge



PRODUCT	CODE	DLR €	10%	SEASONAL ORDER 20%	RRP €
START SCUBA SET/INT XS	IY721700	456.24	410.62	364.99	649.99
START SCUBA SET/INT S	IY721701	456.24	410.62	364.99	649.99
START SCUBA SET/INT M	IY721702	456.24	410.62	364.99	649.99
START SCUBA SET/INT L	IY721703	456.24	410.62	364.99	649.99
START SCUBA SET/INT XL	IY721704	456.24	410.62	364.99	649.99
START SCUBA SET/DIN XS	IY721710	456.24	410.62	364.99	649.99
START SCUBA SET/DIN S	IY721711	456.24	410.62	364.99	649.99
START SCUBA SET/DIN M	IY721712	456.24	410.62	364.99	649.99
START SCUBA SET/DIN L	IY721713	456.24	410.62	364.99	649.99
START SCUBA SET/DIN XL	IY721714	456.24	410.62	364.99	649.99

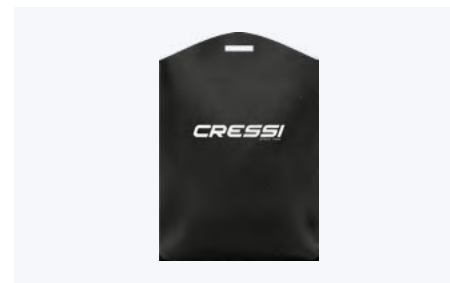

# SOLID SCUBA SET NEW 2023

## SPECIFIC FOR DIVE CENTERS

A COMPLETE SCUBA SET INCLUDING:

- B.C.D. Solid
- 1st stage AC2
- 2nd stage compact
- Octopus compact
- Pressure Gauge



A READY TO USE SET  
TO START SCUBA DIVING

CONVENIENT AND  
QUALITY EQUIPMENT

### TECHNICAL FEATURES 1ST STAGE

- Unbalanced piston
- 1 outlets HP 7/16 UNF
- 4 outlets MP 3/8 UNF
- Service pressure: 300 bar (4350 psi) DIN version, 232 bar (3365 psi) Yoke version
- Calibration pressure: 9,5-10 Bar
- Brass body Electroless Nickel plated
- High capacity conical filter electroless nickel plated
- Aisi 316 long lasting piston
- Easy external direct IP adjustment system
- Stainless steel spring
- Flow rate: 2100 l/min
- Yoke version weight: 635 gr
- Din version weight: 495 gr

### TECHNICAL FEATURES 2ND STAGE

- Downstream system
- Adjustable Venturi effect
- Patented antifriction lever
- Big purge button
- Anti-scratch surface
- Bayonet-type cap holder with security lock
- Removable exhaust tee without tools
- Weight without hose: 135 gr

**Jacketed hose extremely light and flexible weight: 153 gr**

**Certification EN250/2014 A>10° C**

### TECHNICAL FEATURES B.C.D.

- 500D Cordura (exterior part) and 420D Nylon (interior)
- 2 large accessory holder zip-up pockets
- Light-weight, rigid backplate with carry handle.
- 2 overpressure dump valves
- 2 25 mm technopolymer D-rings on the pockets
- Size shown on shoulder straps
- 50 mm shoulder straps with buckles.

### BUOYANCY

SIZE	NEWTON	KG	POUNDS
XXS	80	8,1	17,9
X5	120	12,2	26,9
S	140	14,2	31,4
M	160	16,3	35,9
L	190	19,3	42,7
XL	220	22,4	49,4
XXL	n/a	n/a	n/a

PRODUCT	CODE	DLR €	10%	SEASONAL ORDER 20%	RRP €
SOLID SCUBA SET INT 2XS	IY730100	424,99	382,49	339,99	599,99
SOLID SCUBA SET INT XS	IY730101	424,99	382,49	339,99	599,99
SOLID SCUBA SET INT S	IY730102	424,99	382,49	339,99	599,99
SOLID SCUBA SET INT M	IY730103	424,99	382,49	339,99	599,99
SOLID SCUBA SET INT L	IY730104	424,99	382,49	339,99	599,99
SOLID SCUBA SET INT XL	IY730105	424,99	382,49	339,99	599,99
SOLID SCUBA SET INT 2XL	IY730106	424,99	382,49	339,99	599,99
SOLID SCUBA SET DIN 2XS	IY730200	424,99	382,49	339,99	599,99
SOLID SCUBA SET DIN XS	IY730201	424,99	382,49	339,99	599,99
SOLID SCUBA SET DIN S	IY730202	424,99	382,49	339,99	599,99
SOLID SCUBA SET DIN M	IY730203	424,99	382,49	339,99	599,99
SOLID SCUBA SET DIN L	IY730204	424,99	382,49	339,99	599,99
SOLID SCUBA SET DIN XL	IY730205	424,99	382,49	339,99	599,99
SOLID SCUBA SET DIN 2XL	IY730206	424,99	382,49	339,99	599,99

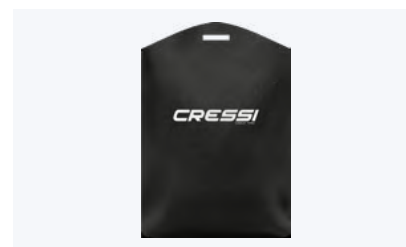



## AVIATOR WAIST BAND



DESCRIPTION	CODE	DLR €	10%	SEASONAL ORDER 20%	RRP €
STANDARD	IZ750140	31,24	28,12	24,99	49,99
EXTENDED +5/10cm	IZ750146	31,24	28,12	24,99	49,98
EXTENDED +10/20cm	IZ750147	31,24	28,12	24,99	49,98

**DESCRIPTION:**  
Interchangeable abdominal bands with Cressi self-pivoting system for Aviator B.C.D. jacket

## ELETTRA WAIST BAND

DESCRIPTION	CODE	DLR €	10%	SEASONAL ORDER 20%	RRP €
ELETTRA WAIST BAND XS	IZ790100	31,24	28,12	24,99	49,98
ELETTRA WAIST BAND S	IZ790101	31,24	28,12	24,99	49,98
ELETTRA WAIST BAND M	IZ790102	31,24	28,12	24,99	49,98
ELETTRA WAIST BAND L	IZ790103	31,24	28,12	24,99	49,98

**DESCRIPTION:**  
Interchangeable abdominal bands with Cressi self-pivoting system for Elettra B.C.D. jacket

## B.C.D.'S INFLATION HOSE

PRODUCT	CODE	DLR €	10%	SEASONAL ORDER 20%	RRP €
STANDARD INFLATION HOSE B.C.D. T5 (CM.69)	IZ750040	24,38	21,94	19,50	38,99

**DESCRIPTION:**  
Standard inflation hose spare part for Cressi Jackets, length 69 cm.  
**SUITABLE FOR:**  
All Cressi B.C.D.'S

## BY-PASS INFLATOR



CODE	DLR €	10%	SEASONAL ORDER 20%	RRP €
IZ750244	33,74	30,37	26,99	53,99

**DESCRIPTION:**  
By-Pass inflator two-piece for jacket  
**SUITABLE FOR:**  
All Cressi B.C.D.'S

## COMPLETE INFLATOR



CODE	DLR €	10%	SEASONAL ORDER 20%	RRP €
IZ750243	67,49	60,74	53,99	107,99

**DESCRIPTION:**  
Complete inflator for jacket. By-Pass included  
**SUITABLE FOR:**  
All Cressi B.C.D.'S

## BACK WEIGHT POCKET



CODE	DLR €	10%	SEASONAL ORDER 20%	RRP €
IC760099	19,99	17,99	15,99	31,99

**DESCRIPTION:**  
Cam Band Trim / Tank Strap Back Weight Pocket  
**SUITABLE FOR:**  
COMMANDER EVOLUTION - PATROL

## FLAT LOCK A.S. POCKET



CODE	DLR €	10%	SEASONAL ORDER 20%	RRP €
IZ750094	23,13	20,82	18,50	36,99

**DESCRIPTION:**  
Flat Lock Aid System weight pocket for Cressi Jacket  
**SUITABLE FOR:**  
Check compatibility at B.C.D.'s comparison table

## S300 LOCK AID SYSTEM



GRÖßE	CODE	DLR €	10%	SEASONAL ORDER 20%	RRP €
M/L/XL	IZ750097	24,38	21,94	19,50	38,99
XS-S	IZ750096	24,38	21,94	19,50	39,88

**SUITABLE FOR:**  
XS-S suitable for old TRAVELIGHT/AIRTRAVEL B.C.D.'S

## WEIGHT POCKET S2011



CODE	DLR €	10%	SEASONAL ORDER 20%	RRP €
IZ750095	16,88	15,19	13,50	26,99

**DESCRIPTION:**  
C.Trim system weight pocket  
**SUITABLE FOR:**  
Cressi S2011 B.C.D. range

/ B.C.D. 'S COMPARISON TABLE



	COMMANDER EVO	CARBON	SCORPION	AQUAWING	AQUAWING PLUS	PATROL	AQUARIDE
<b>TYPE OF AIR CELL MATERIAL</b>	Back Cell Nylon 420 D	Standard Nylon 420 D	Back cell Nylon 420 D	Back Cell Nylon 210 D Cordura 1000 D	Back Cell Nylon 210 D Cordura 1000 D	Back cell Nylon 420 D	Standard Nylon 420 D
<b>BUOYANCY IN NEWTON</b>							
<b>XXS</b>	-	-	-	ONE-SIZE XS-XL	ONE-SIZE XS-XL	-	-
<b>XS</b>	130	80	130			130	80
<b>S</b>	130	90	130			130	90
<b>M</b>	190	130	150			190	130
<b>L</b>	220	160	150			220	160
<b>XL</b>	220	190	150			220	190
<b>XXL</b>	-	-	-			-	-
<b>TYPE OF BACKPLATE / CYLINDER FIXING</b>	Rigid / Single strap	Rigid / Single strap	Soft / Double strap	Rigid / Double strap	Rigid / Double strap	Rigid / Single strap	Rigid / Single strap
<b>COMPATIBLE CYLINDERS LITRES - DIAMETER MM</b>	MONO 10/12/15/18 - 171/203/216	MONO 10/12/15/18 - 171/203/216	MONO 10/12/15/18 - 171/203/216	MONO 10/12/15/18 - 171/203/216	MONO 10/12/15/18 - 171/203/216	MONO 10/12/15/18 - 171/203/216	MONO 10/12/15/18 - 171/203/216
<b>INTEGRATED WEIGHT POCKETS - MAX KG FOR POCKET</b>	Flat lock aid - 4,5+4,5	Flat lock aid - 4,5+4,5	Flat lock aid - 4,5+4,5	NO	Fixed gravity pocket - 3+3	Flat lock aid - 4,5+4,5	Flat lock aid - 4,5+4,5
<b>ABDOMINAL ADJUSTMENT</b>	Buckle	Adjustable waist band + buckle	Buckle	Buckle	Buckle	Buckle + LAS (length adj. system)	Standard waist band + buckle
<b>STERNAL ADJUSTMENT</b>	Fixed	Fixed	Movable	No	No	Fixed	Fixed
<b>SHOULDER STRAP ADJUSTMENT</b>	Standard	Standard	Standard	MAS (Modular Adjustment System)	MAS (Modular Adjustment System)	Standard + LAS (length adj. system)	Standard
<b>QUICK DUMP AND OVER-PRESSURE VALVES</b>							
<b>N°</b>	2	2	2	1	1	2	2
<b>DISCHARGE KNOB POSITION</b>	At the back, lower right area At the front, upper right Area	At the back, lower right area At the front, upper right Area	At the back, lower right area At the front, upper right Area	At the back, lower left area	At the back, lower left area	At the back, lower right area At the front, upper right Area	At the back, lower right area At the front, upper right Area
<b>TOTAL DUMP VALVES</b>	4	4	4	3	3	4	4
<b>N° CHARGE VALVES</b>	2	2	2	2	2	2	2
<b>TYPE OF CONTROL UNIT</b>	FLAT	FLAT	FLAT	FLAT	FLAT	FLAT	FLAT
<b>N° OF POCKETS</b>	2	2	2	-	-	1	2
<b>N° OF BACK POCKETS</b>	2	2	-	2	2	-	2
<b>N° OF "D" RINGS</b>	10	8	4	2	4	6	8
<b>B.C.D. WEIGHT TOTAL BALLAST THAT CAN BE USED (KG)</b>							
<b>XXS</b>	-	-	-	ONE-SIZE XS-XL	ONE-SIZE XS-XL	-	-
<b>XS</b>	3,1 - 14	2,9 - 14	2,4 - 11			2,6 - 9	3,0 - 14
<b>S</b>	3,15 - 14	3 - 14	2,45 - 11			2,6 - 9	3,1 - 14
<b>M</b>	3,25 - 14	3,15 - 14	2,5 - 13			2,75 - 9	3,2 - 14
<b>L</b>	3,4 - 14	3,2 - 14	2,6 - 13			2,9 - 9	3,3 - 14
<b>XL</b>	3,45 - 14	3,3 - 14	2,65 - 13			2,9 - 9	3,4 - 14
<b>XXL</b>	-	-	-			-	-
<b>WEARABILITY: CHEST (CM) - WAIST (CM) - WEIGHT (KG)</b>							
<b>XXS</b>	-	-	-	ONE-SIZE XS-XL	ONE-SIZE XS-XL	-	-
<b>XS</b>	80/90 75/90 55/65	80/90 75/90 55/65	80/90 75/90 55/65			80/90 75/90 55/65	80/90 75/90 55/65
<b>S</b>	90/100 85/95 63/78	90/100 85/95 63/78	90/100 85/95 63/78			90/100 85/95 63/78	90/100 85/95 63/78
<b>M</b>	100/110 95/105 75/85	100/110 95/105 75/85	100/110 95/105 75/85			100/110 95/105 75/85	100/110 95/105 75/85
<b>L</b>	105/115 100/110 80/100	105/115 100/110 80/100	105/115 100/110 80/100			80-130 75-130 55-125	80-130 75-130 55-125
<b>XL</b>	115/125 110/120 110/120	115/125 110/120 110/120	115/125 110/120 110/120			105/115 100/110 80/100	105/115 100/110 80/100
<b>XXL</b>	-	-	-			115/125 110/120 110/120	115/125 110/120 110/120





	ELETTRA	AVIATOR	TRAVELIGHT	START PRO	START	QUARTZ	SOLID
<b>TYPE OF AIR CELL MATERIAL</b>	Standard Nylon 420 D	Standard Nylon 420 D	Standard Nylon 210 D	Standard Cordura 500 D	Standard Cordura 500 D	Standard Cordura 500 D	Standard Cordura 500 D
<b>BUOYANCY IN NEWTON</b>							
<b>XXS</b>	-	-	-	70	-	-	80
<b>XS</b>	100	60	60	130	130	120	120
<b>S</b>	100	80	80	140	140	140	140
<b>M</b>	140	90	90	150	150	160	160
<b>L</b>	160	130	130	170	170	190	190
<b>XL</b>	-	160	160	200	200	220	220
<b>XXL</b>	-	-	-	200	-	-	n/a
<b>TYPE OF BACKPLATE / CYLINDER FIXING</b>	Soft / Double strap	Soft / Double strap	Soft / Double strap	Rigid / Single strap	Rigid / Single strap	Rigid / Single strap	Rigid / Single strap
<b>COMPATIBLE CYLINDERS LITRES - DIAMETER MM</b>	MONO 10/12/15/18 - 171/203/216	MONO 10/12/15/18 - 171/203/216	MONO 10/12/15/18- 171/203/216	MONO 10/12/15/18- 171/203/216	MONO 10/12/15/18- 171/203/216	MONO 10/12/15/18- 171/203/216	MONO 10/12/15/18- 171/203/216
<b>INTEGRATED WEIGHT POCKETS - MAX KG FOR POCKET</b>	Flat lock aid - 4,5+4,5	Flat lock aid - 4,5+4,5	Flat lock aid - 4,5+4,5	Fixed gravity pocket - 2+2 (xxs, xs, s) / 3+3 (m, l, xl)	NO	Flat lock aid - 4,5+4,5	NO
<b>ABDOMINAL ADJUSTMENT</b>	Buckle + SPWB (self pivoting waistband) "B"	Buckle + SPWB (self pivoting waistband) "A"	Standard waist band + buckle	Standard waist band + buckle	Standard waist band + buckle	Standard waist band + buckle	Standard waist band + buckle
<b>STERNAL ADJUSTMENT</b>	Movable	Fixed	Fixed	Fixed	Fixed	Fixed	Fixed
<b>SHOULDER STRAP ADJUSTMENT</b>	Standard	Standard	Standard	Standard	Standard	Standard	Standard
<b>QUICK DUMP AND OVER-PRESSURE VALVES</b>							
<b>N°</b>	2	2	2	2	2	2	2
<b>DISCHARGE KNOB POSITION</b>	At the back, lower right area At the front, upper right Area	At the front, lower right area At the front, upper right Area	At the front, lower right area At the front, upper right Area	At the back, lower right area At the front, upper right Area	At the back, lower right area At the front, upper right Area	At the back, lower right area At the front, upper right Area	At the back, lower right area At the front, upper right Area
<b>TOTAL DUMP VALVES</b>	4	4	4	4	4	4	4
<b>N° CHARGE VALVES</b>	2	2	2	2	2	2	2
<b>TYPE OF CONTROL UNIT</b>	FLAT	FLAT	FLAT	FLAT	FLAT	FLAT	FLAT
<b>N° OF POCKETS</b>	2	2	2	2	2	2	2
<b>N° OF BACK POCKETS</b>	-	2	2	-	-	-	-
<b>N° OF "D" RINGS</b>	6	6	6	6	4	5	3
<b>B.C.D. WEIGHT TOTAL BALLAST THAT CAN BE USED (KG)</b>							
<b>XXS</b>	-	-	-	2,4 - 4	-	-	2,1 - NO
<b>XS</b>	2,95 - 9	2,5 - 14	2,4 - 14	2,5 - 4	2,4 - NO	2,6 - 9	2,2 - NO
<b>S</b>	3 - 9	2,5 - 14	2,4 - 14	2,5 - 4	2,5 - NO	2,7 - 9	2,25 - NO
<b>M</b>	3,1 - 9	2,6 -14	2,5 -14	2,75 - 6	2,6 - NO	2,9 - 9	2,3 - NO
<b>L</b>	3,15 - 9	2,6 -14	2,5 -14	2,8 - 6	2,7 - NO	2,9 - 9	2,35 - NO
<b>XL</b>	-	2,7 -14	2,6 -14	2,9 - 6	2,8 - NO	2,93 - 9	2,4 - NO
<b>XXL</b>	-	-	-	2,9	-	-	n/a
<b>WEARABILITY: CHEST (CM) - WAIST (CM) - WEIGHT (KG)</b>							
<b>XXS</b>	-	-	-	70/85 70/80 48/60	-	-	70/85 70/80 48/60
<b>XS</b>	80/90 75/90 55/65	80/90 75/90 55/65	80/90 75/90 55/65	80/90 75/90 55/65	80/90 75/90 55/65	80/90 75/90 55/65	80/90 75/90 55/65
<b>S</b>	90/100 85/95 63/78	90/100 85/95 63/78	90/100 85/95 63/78	90/100 85/95 63/78	90/100 85/95 63/78	90/100 85/95 63/78	90/100 85/95 63/78
<b>M</b>	100/110 95/105 75/85	100/110 95/105 75/85	100/110 95/105 75/85	100/110 95/105 75/85	100/110 95/105 75/85	100/110 95/105 75/85	100/110 95/105 75/85
<b>L</b>	105/115 100/110 80/100	105/115 100/110 80/100	105/115 100/110 80/100	105/115 100/110 80/100	105/115 100/110 80/100	105/115 100/110 80/100	105/115 100/110 80/100
<b>XL</b>	-	115/125 110/120 110/120	115/125 110/120 110/120	115/125 110/120 110/120	115/125 110/120 110/120	115/125 110/120 110/120	115/125 110/120 110/120
<b>XXL</b>	-	-	-	125/130 120/130 120/125	-	-	125/130 120/130 120/125



# WETSUITS







# GLACIER SPECIALIZED

Retailer-Product

NEW 2023

THICKNESS 4 MM HIGH DENSITY | ANTI-ABRASION X-DIAMOND PADS | ADDITIONAL PROTECTIVE NEOPRENE COLLAR

## HIGH DENSITY 4 mm DRYSUIT

Glacier is a 4mm precompressed high-density neoprene, heavy duty, dry-suit. The main feature of Glacier is in its collar and wrist sealing. It is made of latex. This ensures the best adherence possible to your body and minimizes the chance of water leaking in the suit. Both collar and wrist sealing are customizable. Have them cut to your precise size to have a perfect fit. Collar and wrists are replaceable too, in case they wear out or

accidentally tear. Glacier features a second 1.5 mm neoprene collar, for additional thermal protection. Shoulders, back, hips and knees are reinforced with X-Diamond pad material, making this wetsuit very resistant to abrasion. The feet are made of soft and elastic neoprene for a comfortable fit. Inside the dry-suit a pair of suspenders will hold the suit in place when it is open. The zip is covered by a neoprene flap.

The charging valve is activated by a side button, while the deflating valve is adjustable. Glacier features two large pockets on the sides of the legs to comfortably place the additional gear you want to carry with you underwater.



### TECHNICAL FEATURES

- 4 mm High-density prestressed neoprene (external / internal nylon)
- Double storage pocket (one on the right and one on the left)
- Latex collar and cuffs
- Additional 1.5 mm neoprene thermal protection collar
- Shoulders, upper back, hips and lumbar area, knees with the special anti-abrasion X-Diamond Pad lining.
- Soft neoprene boots
- Internal braces
- Zipper flap
- Side-operated swivel fill valve
- Adjustable discharge relief valve

### LATEX COLLAR + THERMIC NEOPRENE COLLAR

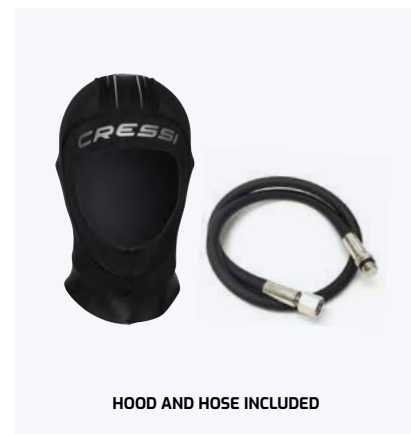
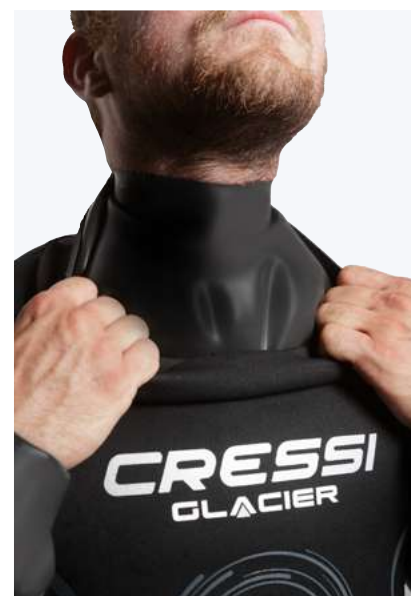

HOOD AND HOSE INCLUDED

PRODUCT	THK	SIZE	CODE	DLR €	10%	SEASONAL ORDER 20%	RRP €
GLACIER DRY SUIT	4 mm	MAN S/2	LQ401302	874,99	787,49	699,99	1249,99
GLACIER DRY SUIT	4 mm	MAN M/3	LQ401303	874,99	787,49	699,99	1249,99
GLACIER DRY SUIT	4 mm	MAN L/4	LQ401304	874,99	787,49	699,99	1249,99
GLACIER DRY SUIT	4 mm	MAN XL/5	LQ401305	874,99	787,49	699,99	1249,99
GLACIER DRY SUIT	4 mm	MAN 2L/6	LQ401306	874,99	787,49	699,99	1249,99
GLACIER DRY SUIT	4 mm	MAN 3XL/7	LQ401307	874,99	787,49	699,99	1249,99
GLACIER DRY SUIT	4 mm	LADY XS/1	LQ401401	874,99	787,49	699,99	1249,99
GLACIER DRY SUIT	4 mm	LADY S/2	LQ401402	874,99	787,49	699,99	1249,99
GLACIER DRY SUIT	4 mm	LADY M/3	LQ401403	874,99	787,49	699,99	1249,99
GLACIER DRY SUIT	4 mm	LADY L/4	LQ401404	874,99	787,49	699,99	1249,99
GLACIER DRY SUIT	4 mm	LADY XL/5	LQ401405	874,99	787,49	699,99	1249,99
GLACIER DRY SUIT	4 mm	LADY 2XL/6	LQ401406	874,99	787,49	699,99	1249,99
INFLATAION HOSE + OR FOR DRY SUIT (86cm)			LZ750038	25,63	23,07	20,50	40,99



# DESERT

## HIGH DENSITY 4 mm DRYSUIT

Comfortable and resistant thanks to its 4mm thick High-Density pre-compressed neoprene dry suit and Liquid Seal protected stitched joints. The seams and outer neoprene lining are covered with a special layer of elastomer so as to simultaneously create an impermeable obstacle for the water and increased resistance at the joints. On the inside, an additional sealing strip guarantees total waterproof-ability. This

double sealing system has been carefully designed to meet the needs of the most discerning and seasoned divers that often require their dry suits to be able to adapt to extreme working or weather conditions. The special Spanflex material has also been used in the outer part so as to increase elasticity and abrasion resistance. The cuffs are made of smooth 3,5 mm-thick neoprene on the inside in order to improve sealability and from

Ultraspan on the outside in order to improve elasticity. The collar is made of the same materials but with 2,5mm-thick neoprene for more comfort and breathability when turned-up. The shoulder neck and knee lines are reinforced with a special anti-abrasion X-Diamond Pad lining. The suit comes with a practical multipurpose pocket placed on the right leg as well as a comfortable hood.



SMOOTH SKIN NEOPRENE (NECK, WRISTS)

ULTRA DURABLE X-DIAMOND PAD (SHOULDERS, CHEST, KNEES)

HIGH VOLUME POCKET D-RING AND HOOD HOLDER

SOFT NEOPRENE SOCKS

### TECHNICAL FEATURES

- 4 mm-thick High-Density pre-compressed neoprene.
- Soft neoprene socks.
- Internal suspender system.
- Fly with concealed zip.
- Heavy duty kneepads
- Side action rotating inflation valve.
- Adjustable discharge relief valve.

### LIQUID SEAL TECHNOLOGY

A layer of polymer is spread along the seams to protect and seal them, thereby increasing the resistance to wear, the lifetime of the suit, and its insulating power.



PRODUCT	THK	SIZE	CODE	DLR €	10%	SEASONAL ORDER 20%	RRP €
DESERT DRY SUIT HD	4 mm	MAN S/2	LQ401002	787,49	708,74	629,99	1109,99
DESERT DRY SUIT HD	4 mm	MAN M/3	LQ401003	787,49	708,74	629,99	1109,99
DESERT DRY SUIT HD	4 mm	MAN L/4	LQ401004	787,49	708,74	629,99	1109,99
DESERT DRY SUIT HD	4 mm	MAN XL/5	LQ401005	787,49	708,74	629,99	1109,99
DESERT DRY SUIT HD	4 mm	MAN 2L/6	LQ401006	787,49	708,74	629,99	1109,99
DESERT DRY SUIT HD	4 mm	MAN 3XL/7	LQ401007	787,49	708,74	629,99	1109,99
DESERT DRY SUIT HD	4 mm	LADY XS/1	LQ401101	787,49	708,74	629,99	1109,99
DESERT DRY SUIT HD	4 mm	LADY S/2	LQ401102	787,49	708,74	629,99	1109,99
DESERT DRY SUIT HD	4 mm	LADY M/3	LQ401103	787,49	708,74	629,99	1109,99
DESERT DRY SUIT HD	4 mm	LADY L/4	LQ401104	787,49	708,74	629,99	1109,99
DESERT DRY SUIT HD	4 mm	LADY XL/5	LQ401105	787,49	708,74	629,99	1109,99
INFLATION HOSE + OR FOR DRY SUIT (86cm)			LZ750038	25,63	23,07	20,50	40,99

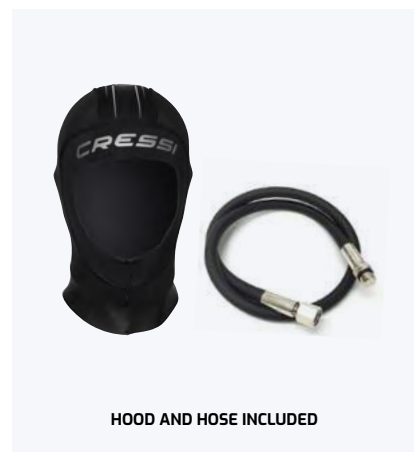

HOOD AND HOSE INCLUDED

# DRYSUIT UNDERSUIT

RECYCLED MATERIALS

BASE LAYER NEW FLEECE FABRIC

## THERMAL UNDERSUIT

The Undersuit is an undersuit to wear underneath your scuba diving drysuit for more warmth. It is lightweight with a front vertical zipper, plus elastic feet and hand stirrups for a more convenient experience. It is composed of recycled polyester and recycled spandex.

### TECHNICAL FEATURES

- Suit for diving
- Recycled polyester + recycled spandex
- Thumb-hole design
- 550g/yd



PRODUCT	SIZE	CODE	DLR €	10%	SEASONAL ORDER 20%	RRP €
UNDERSUIT for DRY SUIT	UNISEX XS/1	LW475011	93,74	84,37	74,99	149,99
UNDERSUIT for DRY SUIT	UNISEX S/2	LW475012	93,74	84,37	74,99	149,99
UNDERSUIT for DRY SUIT	UNISEX M/3	LW475013	93,74	84,37	74,99	149,99
UNDERSUIT for DRY SUIT	UNISEX L/4	LW475014	93,74	84,37	74,99	149,99
UNDERSUIT for DRY SUIT	UNISEX XL/5	LW475015	93,74	84,37	74,99	149,99
UNDERSUIT for DRY SUIT	UNISEX 2XL/6	LW475016	93,74	84,37	74,99	149,99
UNDERSUIT for DRY SUIT	UNISEX 3XL/7	LW475017	93,74	84,37	74,99	149,99



**ICE**  **SPECIALIZED**  
Retailer-Product

THICKNESS  
7 MM

DRY BACK  
ZIP

100% HIGH  
STRETCH CONCEPT

ELASTIC  
PLUSH INSIDE

10-18° C  
50-64.4° F  
CE CERTIFICATION  
DIVING WETSUIT  
EN 14225-1:2017: B



**SEMI-DRYSUIT 7 mm**

One-piece 7 mm semi-dry suit for cold water. Very easy to wear thanks to special outer ELASTIC SPAN cover and internal ELASTIC PLUSH lining. To facilitate the diver who carries important accessories, the suit is equipped with a convenient double compartment side pocket. One of them has a zipper closure while the other, intended for objects needing faster retrieved, has a Velcro

closing. Two D-RINGS allow you to secure objects. It has a HOOD HOLDER for attaching the hood and special SMALL DYMOND anti-abrasion reinforcements on the shoulders, knees and on the back side. Double cuffs on wrists and ankles. Comfortable waterproof MASTER SEAL rear zip.



**TECHNICAL FEATURES**

- 7 mm-thick neoprene
- Elastic-span
- Elastic plush inside
- High volume pocket d-ring and hood holder
- Ankles and wrists with double cuffs



HIGH VOLUME POCKET D-RING AND HOOD HOLDER



HORIZONTAL DRY BACK TIZIP® MASTERSEAL

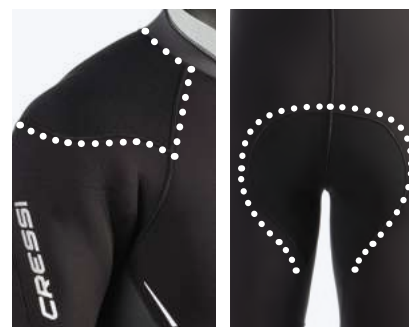

REINFORCED NEOPRENE

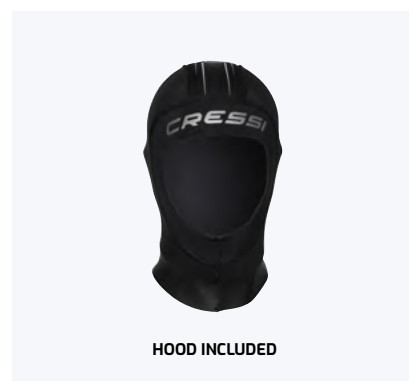

HOOD INCLUDED

PRODUCT	THK	SIZE	CODE	DLR €	10%	SEASONAL ORDER 20%	RRP €
ICE SEMI-DRY WETSUIT	7 mm	MAN S/2	LQ403002	437.49	393.74	349.99	649.99
ICE SEMI-DRY WETSUIT	7 mm	MAN M/3	LQ403003	437.49	393.74	349.99	649.99
ICE SEMI-DRY WETSUIT	7 mm	MAN L/4	LQ403004	437.49	393.74	349.99	649.99
ICE SEMI-DRY WETSUIT	7 mm	MAN XL/5	LQ403005	437.49	393.74	349.99	649.99
ICE SEMI-DRY WETSUIT	7 mm	MAN 2XL/6	LQ403006	437.49	393.74	349.99	649.99
ICE SEMI-DRY WETSUIT	7 mm	MAN 3XL/7	LQ403007	437.49	393.74	349.99	649.99
ICE SEMI-DRY WETSUIT	7 mm	LADY XS/1	LQ403101	437.49	393.74	349.99	649.99
ICE SEMI-DRY WETSUIT	7 mm	LADY S/2	LQ403102	437.49	393.74	349.99	649.99
ICE SEMI-DRY WETSUIT	7 mm	LADY M/3	LQ403103	437.49	393.74	349.99	649.99
ICE SEMI-DRY WETSUIT	7 mm	LADY L/4	LQ403104	437.49	393.74	349.99	649.99
ICE SEMI-DRY WETSUIT	7 mm	LADY XL/5	LQ403105	437.49	393.74	349.99	649.99

# FACILE SPECIALIZED

Retailer-Product

MULTI THICKNESS  
8+6+5 MM

FRONT  
ZIP

ELASTIC SPAN  
OUTSIDE

X-PLUSH  
INSIDE

7-12° C  
44,6-53,6° F  
CE CERTIFICATION  
DIVING WETSUIT  
EN 14225-1:2017: A



## MULTI THICKNESS WETSUIT 8+6+5 mm

One-piece wetsuit with different thicknesses (8, 6.5 e 5 mm) and attached hood for cold water. The suit is characterized by the WATER STOP SYSTEM, whereby a particular bib inside in ULTRASTRETCH material creates a double barrier against water infiltration and improves thermal insulation.

Transverse front zipper, along with the special ELASTIC SPAN cover and X-PLUSH lining, greatly facilitate the fit and donning. Special 6.5 mm inserts on the arms and legs improve the joint anatomy, enabling smoother motion. Additional pre-bent embossing in the folds of the joints.

SMALL DIAMOND anti abrasion reinforcements on the shoulder and back side (buttocks). Protective reinforcement on the knees. 5 mm hood with Air Free valve to remove the air. Wrists and ankles have double cuffs with a zip; the size is printed in evidence on the inside wrists.



### TECHNICAL FEATURES

- Multi thickness wetsuit
- Front zip
- Elastic span outside, x-plush inside
- Ankles and wrists with double cuffs

### Thickness composition



WATER STOP SYSTEM

HOOD, AIR FREE VALVE



REINFORCED NEOPRENE

PRODUCT	THK	SIZE	CODE	DLR €	10%	SEASONAL ORDER 20%	RRP €
FACILE MONOPIECE WETSUIT	8 mm	LADY XS/1	LT473501	262,49	236,24	209,99	409,99
FACILE MONOPIECE WETSUIT	8 mm	LADY S/2	LT473502	262,49	236,24	209,99	409,99
FACILE MONOPIECE WETSUIT	8 mm	LADY M/3	LT473503	262,49	236,24	209,99	409,99
FACILE MONOPIECE WETSUIT	8 mm	LADY L/4	LT473504	262,49	236,24	209,99	409,99
FACILE MONOPIECE WETSUIT	8 mm	LADY XL/5	LT473505	262,49	236,24	209,99	409,99
FACILE MONOPIECE WETSUIT	8 mm	MAN S/2	LT473402	262,49	236,24	209,99	409,99
FACILE MONOPIECE WETSUIT	8 mm	MAN M/3	LT473403	262,49	236,24	209,99	409,99
FACILE MONOPIECE WETSUIT	8 mm	MAN L/4	LT473404	262,49	236,24	209,99	409,99
FACILE MONOPIECE WETSUIT	8 mm	MAN XL/5	LT473405	262,49	236,24	209,99	409,99
FACILE MONOPIECE WETSUIT	8 mm	MAN 2XL/6	LT473406	262,49	236,24	209,99	409,99



# COMFORT

THICKNESS  
7 MM

BACK  
ZIP

100%  
ELASTIC SPAN

ELASTIC  
PLUSH INSIDE

10-18° C  
50-64.4° F  
CE CERTIFICATION  
DIVING WETSUIT  
EN 14225-1:2017: B



## 100% HIGH-STRETCH MONOPIECE WETSUIT 7 mm

One piece cold water wetsuit made of 7 mm neoprene, with an outer layer in Elastic-Span and inner lining in Elastic-Plush. These materials make the suit warm and extremely elastic, making it very easy to put on. A YKK zipper (ensuring optimal quality) runs vertically on the back. The knees

are reinforced with special protective patches. A very handy pocket on the right leg has two compartments and a useful D-ring. Double sleeves and zippers on wrists and ankles. A special sealing system on the collar minimises water infiltration.

### TECHNICAL FEATURES

- 7 mm-thick neoprene
- Elastic-span
- Elastic plush inside
- High volume pocket d-ring and hood holder
- Ankles and wrists with zips and double cuffs
- Anti-seepage collar



PRODUCT	THK	SIZE	CODE	DLR €	10%	SEASONAL ORDER 20%	RRP €
COMFORT MONOPIECE WETSUIT	7 mm	MAN S/2	LS507202	249.99	224.99	199.99	399.99
COMFORT MONOPIECE WETSUIT	7 mm	MAN M/3	LS507203	249.99	224.99	199.99	399.99
COMFORT MONOPIECE WETSUIT	7 mm	MAN L/4	LS507204	249.99	224.99	199.99	399.99
COMFORT MONOPIECE WETSUIT	7 mm	MAN XL/5	LS507205	249.99	224.99	199.99	399.99
COMFORT MONOPIECE WETSUIT	7 mm	MAN 2XL/6	LS507206	249.99	224.99	199.99	399.99
COMFORT MONOPIECE WETSUIT	7 mm	MAN 3XL/7	LS507207	249.99	224.99	199.99	399.99
COMFORT MONOPIECE WETSUIT	7 mm	LADY XS/1	LS507301	249.99	224.99	199.99	399.99
COMFORT MONOPIECE WETSUIT	7 mm	LADY S/2	LS507302	249.99	224.99	199.99	399.99
COMFORT MONOPIECE WETSUIT	7 mm	LADY M/3	LS507303	249.99	224.99	199.99	399.99
COMFORT MONOPIECE WETSUIT	7 mm	LADY L/4	LS507304	249.99	224.99	199.99	399.99
COMFORT MONOPIECE WETSUIT	7 mm	LADY XL/5	LS507305	249.99	224.99	199.99	399.99
COMFORT MONOPIECE WETSUIT	7 mm	LADY 2XL/6	LS507306	249.99	224.99	199.99	399.99

# COMFORT

THICKNESS  
5 MM

BACK  
ZIP

100%  
ELASTIC SPAN

ELASTIC  
PLUSH INSIDE

16-24° C  
60.8-75.2° F  
CE CERTIFICATION  
DIVING WETSUIT  
EN 14225-1:2017: C



## 100% HIGH-STRETCH MONOPIECE WETSUIT 5 mm

One piece wet suit for temperate waters. Made of 5mm-thick neoprene with Elastic-Span external lining and Elastic-Plush internal lining. These materials enhance elasticity, heat level and wearability.

The zip is a YKK in order to guarantee maximum quality and is placed vertically on the rear-side of the suit. The suit includes heavy duty kneepads for extra protection.

### TECHNICAL FEATURES

- 5 mm-thick neoprene
- Elastic-span
- Elastic plush inside
- Hood holder



PRODUCT	THK	SIZE	CODE	DLR €	10%	SEASONAL ORDER 20%	RRP €
COMFORT MONOPIECE WETSUIT BLACK	5 mm	MAN S/2	LS507002	199.99	179.99	159.99	329.99
COMFORT MONOPIECE WETSUIT BLACK	5 mm	MAN M/3	LS507003	199.99	179.99	159.99	329.99
COMFORT MONOPIECE WETSUIT BLACK	5 mm	MAN L/4	LS507004	199.99	179.99	159.99	329.99
COMFORT MONOPIECE WETSUIT BLACK	5 mm	MAN XL/5	LS507005	199.99	179.99	159.99	329.99
COMFORT MONOPIECE WETSUIT BLACK	5 mm	MAN 2XL/6	LS507006	199.99	179.99	159.99	329.99
COMFORT MONOPIECE WETSUIT BLACK	5 mm	MAN 3XL/7	LS507007	199.99	179.99	159.99	329.99
COMFORT MONOPIECE WETSUIT BLACK	5 mm	LADY XS/1	LS507101	199.99	179.99	159.99	329.99
COMFORT MONOPIECE WETSUIT BLACK	5 mm	LADY S/2	LS507102	199.99	179.99	159.99	329.99
COMFORT MONOPIECE WETSUIT BLACK	5 mm	LADY M/3	LS507103	199.99	179.99	159.99	329.99
COMFORT MONOPIECE WETSUIT BLACK	5 mm	LADY L/4	LS507104	199.99	179.99	159.99	329.99
COMFORT MONOPIECE WETSUIT BLACK	5 mm	LADY XL/5	LS507105	199.99	179.99	159.99	329.99
COMFORT MONOPIECE WETSUIT BLACK	5 mm	LADY 2XL/6	LS507106	199.99	179.99	159.99	329.99



# FAST SPECIALIZED MONOPIECE WETSUIT 7 mm

THICKNESS 7 MM | BACK ZIP

10-18° C  
50-64.4° F  
CE CERTIFICATION  
DIVING WETSUIT  
EN 14225-1:2017: B



Stylish, warm and versatile, the Fast can be used in the widest range of temperate and cold waters. Durable 7 mm, double-lined neoprene, stands up

well to compression at depth for maximum heat retention. Pre-shaped legs improve flexibility for easier kicking.



## TECHNICAL FEATURES

- One-piece 7 mm wetsuit in double lined neoprene
- Ultraspan neoprene on arms and calves
- Pre-shaped legs
- YKK back zip with under zip lining and water-stop system
- Anti-abrasion reinforcement on the knees
- Wrists and ankles with water-stop system / watertight seals



WATERTIGHT SEALS



UNDER ZIP LINING



NEW DESIGN KNEEPAD

PRODUCT	THK	SIZE	CODE	DLR €	10%	SEASONAL ORDER 20%	RRP €
FAST MONOPIECE WETSUIT	7 mm	MAN S/2	LR108702	181.24	163.12	144.99	274.99
FAST MONOPIECE WETSUIT	7 mm	MAN M/3	LR108703	181.24	163.12	144.99	274.99
FAST MONOPIECE WETSUIT	7 mm	MAN L/4	LR108704	181.24	163.12	144.99	274.99
FAST MONOPIECE WETSUIT	7 mm	MAN XL/5	LR108705	181.24	163.12	144.99	274.99
FAST MONOPIECE WETSUIT	7 mm	MAN 2XL/6	LR108706	181.24	163.12	144.99	274.99
FAST MONOPIECE WETSUIT	7 mm	MAN 3XL/7	LR108707	181.24	163.12	144.99	274.99
FAST MONOPIECE WETSUIT	7 mm	LADY XS/1	LR109701	181.24	163.12	144.99	274.99
FAST MONOPIECE WETSUIT	7 mm	LADY S/2	LR109702	181.24	163.12	144.99	274.99
FAST MONOPIECE WETSUIT	7 mm	LADY M/3	LR109703	181.24	163.12	144.99	274.99
FAST MONOPIECE WETSUIT	7 mm	LADY L/4	LR109704	181.24	163.12	144.99	274.99
FAST MONOPIECE WETSUIT	7 mm	LADY XL/5	LR109705	181.24	163.12	144.99	274.99



**FAST**  **SPECIALIZED**  
Retailer-Product

**MONOPIECE WETSUIT 5 mm**

Stylish, warm and versatile, the Fast can be used in the widest range of temperate waters. Durable 5 mm, double-lined neoprene, stands up well to

compression at depth for maximum heat retention. Pre-shaped legs improve flexibility for easier kicking.

THICKNESS  
5 MM

BACK  
ZIP

16-24° C  
60.8-75.2° F  
CE CERTIFICATION  
DIVING WETSUIT  
EN 14225-1:2017: C



ANTI-ABRASION  
REINFORCEMENT

**TECHNICAL FEATURES**

- One-piece wetsuit in 5 mm double lined neoprene
- Pre-shaped legs
- YKK back zip with under zip lining and water-stop system
- Anti-abrasion reinforcement on the knees
- Wrists and ankles with water-stop system / watertight seals



WATERTIGHT SEALS



UNDER ZIP LINING



NEW DESIGN KNEEPAD

PRODUCT	THK	SIZE	CODE	DLR €	10%	SEASONAL ORDER 20%	RRP €
FAST MONOPIECE WETSUIT	5 mm	MAN S/2	LR108502	143.74	129.37	114.99	219.99
FAST MONOPIECE WETSUIT	5 mm	MAN M/3	LR108503	143.74	129.37	114.99	219.99
FAST MONOPIECE WETSUIT	5 mm	MAN L/4	LR108504	143.74	129.37	114.99	219.99
FAST MONOPIECE WETSUIT	5 mm	MAN XL/5	LR108505	143.74	129.37	114.99	219.99
FAST MONOPIECE WETSUIT	5 mm	MAN 2XL/6	LR108506	143.74	129.37	114.99	219.99
FAST MONOPIECE WETSUIT	5 mm	MAN 3XL/7	LR108507	143.74	129.37	114.99	219.99
FAST MONOPIECE WETSUIT	5 mm	LADY XS/1	LR109501	143.74	129.37	114.99	219.99
FAST MONOPIECE WETSUIT	5 mm	LADY S/2	LR109502	143.74	129.37	114.99	219.99
FAST MONOPIECE WETSUIT	5 mm	LADY M/3	LR109503	143.74	129.37	114.99	219.99
FAST MONOPIECE WETSUIT	5 mm	LADY L/4	LR109504	143.74	129.37	114.99	219.99
FAST MONOPIECE WETSUIT	5 mm	LADY XL/5	LR109505	143.74	129.37	114.99	219.99





**FAST**  **SPECIALIZED**  
Retailer-Product

**MONOPIECE WETSUIT 3 mm**

Stylish, warm and versatile, the Fast can be used in the widest range of temperate waters. Durable 3 mm neoprene, pre-shaped legs improve flexibility

for easier kicking and anti-abrasion reinforcement on the knees.

THICKNESS  
3 MM

BACK  
ZIP

 >22° C  
>71.6° F  
CE CERTIFICATION  
SURFACE WETSUIT  
EN 14225-1:2017: D



**TECHNICAL FEATURES**

- One-piece wetsuit in 3 mm double lined neoprene
- Pre-shaped legs
- YKK back zip with under zip lining
- Anti-abrasion reinforcement on the knees

PRODUCT	THK	SIZE	CODE	DLR €	10%	SEASONAL ORDER 20%	RRP €
FAST MONOPIECE WETSUIT	3 mm	MAN S/2	LR108302	104,99	94,49	83,99	164,99
FAST MONOPIECE WETSUIT	3 mm	MAN M/3	LR108303	104,99	94,49	83,99	164,99
FAST MONOPIECE WETSUIT	3 mm	MAN L/4	LR108304	104,99	94,49	83,99	164,99
FAST MONOPIECE WETSUIT	3 mm	MAN XL/5	LR108305	104,99	94,49	83,99	164,99
FAST MONOPIECE WETSUIT	3 mm	MAN 2XL/6	LR108306	104,99	94,49	83,99	164,99
FAST MONOPIECE WETSUIT	3 mm	MAN 3XL/7	LR108307	104,99	94,49	83,99	164,99
FAST MONOPIECE WETSUIT	3 mm	LADY XS/1	LR109301	104,99	94,49	83,99	164,99
FAST MONOPIECE WETSUIT	3 mm	LADY S/2	LR109302	104,99	94,49	83,99	164,99
FAST MONOPIECE WETSUIT	3 mm	LADY M/3	LR109303	104,99	94,49	83,99	164,99
FAST MONOPIECE WETSUIT	3 mm	LADY L/4	LR109304	104,99	94,49	83,99	164,99
FAST MONOPIECE WETSUIT	3 mm	LADY XL/5	LR109305	104,99	94,49	83,99	164,99

# FISTERRA SPECIALIZED Retailer-Product

AVAILABLE IN TWO THICKNESS: 8 OR 5 MM

TWO-PIECE WETSUIT

ULTRA DURABLE NEOPRENE

 7-12° C  
 44.6-53.6° F  
CE CERTIFICATION DIVING WETSUIT EN 14225-1:2017: A

**8 mm**  
**CE**

 16-24° C  
 60.8-75.2° F  
CE CERTIFICATION DIVING WETSUIT EN 14225-1:2017: C

**5 mm**  
**CE**

## TWO-PIECE WETSUIT 8 mm, 5 mm

### ROBUST WETSUIT ALSO IDEAL FOR COMMERCIAL FISHING

Fisterra was originally born in version 8mm, to respond to the need of professional divers in cold waters. The demand for professional divers, diving instructors and users who demand maximum thermal performance and comfort has encouraged us to incorporate a 5 mm version for temperate waters into the collection.

Fisterra 5 mm is a resistant, very watertight and highly thermal combination with jacket without zippers and high trousers with dungarees. A combination that combines, therefore,

characteristics that place it at the apex of pure performance in a wetsuit of this thickness. Low-compression LC neoprene that guarantees optimum thermal protection at the bottom due to its high resistance to compression ideal for professional work or long duration diving. Nylon outer lining of high weight very resistant, interior X-Plush elastic terry loop, waterproof and great sliding that facilitates the placement and removal of the suit at the same time has a large thermal memory. Wide anti-abrasion knee-spin pads and elbow pads in Supratex®.

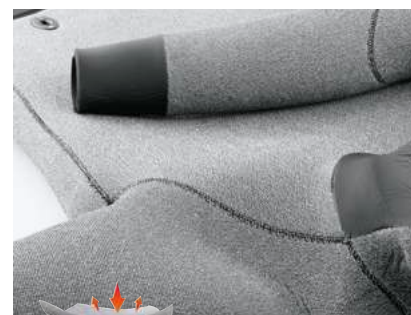

ELASTIC PLUSH INSIDE



PRODUCT	THK	SIZE	CODE	DLR €	10%	SEASONAL ORDER 20%	RRP €
FISTERRA TWO-PIECE WETSUIT	8 mm	S/2	LK489502	249,99	224,99	199,99	379,99
FISTERRA TWO-PIECE WETSUIT	8 mm	M/3	LK489503	249,99	224,99	199,99	379,99
FISTERRA TWO-PIECE WETSUIT	8 mm	L/4	LK489504	249,99	224,99	199,99	379,99
FISTERRA TWO-PIECE WETSUIT	8 mm	XL/5	LK489505	249,99	224,99	199,99	379,99
FISTERRA TWO-PIECE WETSUIT	8 mm	2XL/6	LK489506	249,99	224,99	199,99	379,99
FISTERRA TWO-PIECE WETSUIT	5 mm	S/2	LK489002	193,74	174,37	154,99	294,99
FISTERRA TWO-PIECE WETSUIT	5 mm	M/3	LK489003	193,74	174,37	154,99	294,99
FISTERRA TWO-PIECE WETSUIT	5 mm	L/4	LK489004	193,74	174,37	154,99	294,99
FISTERRA TWO-PIECE WETSUIT	5 mm	XL/5	LK489005	193,74	174,37	154,99	294,99
FISTERRA TWO-PIECE WETSUIT	5 mm	2XL/6	LK489006	193,74	174,37	154,99	294,99





# MEDAS

## TWO-PIECE WETSUIT 5 mm

The Medas is a classic 5+5 mm suit apt for dives in temperate waters, and also useful in cold waters with use of an inner vest.

Renovated pattern, with larger more anatomical panels, in a discrete and elegant combination of black and blue for the male version and black and turquoise for the female version, with contrasting seams and the new logos sporting a more modern look. The pattern of this model is derived from the

most sophisticated Cressi dive models and thus is very anatomical, with preformed legs and arms for an always-natural position and without any seams in the armpit area.

The purchase price is contained, the pattern, the production, and the attention to details make it a great choice and it is one of the most widely used globally.

THICKNESS  
5 MM

FRONT  
ZIP

TWO-PIECE  
WETSUIT

16-24° C  
60.8-75.2° F  
CE CERTIFICATION  
DIVING WETSUIT  
EN 14225-1:2017: C



### TECHNICAL FEATURES

- Wrists and ankles with "Glide Skin" smooth neoprene micro cuff seals
- Powertex® knee-shin pads
- RIRI® 8 pitch diagonal frontal zipper with metallic pull to prevent tearing
- The facial contouring and neck area have a smooth neoprene insert to minimize leaks.
- Pants with a high closed bib and zipper for greater insulation
- Clip closure in male version and swimsuit style in female version



PRODUCT	THK	SIZE	CODE	DLR €	10%	SEASONAL ORDER 20%	RRP €
MEDAS TWO-PIECE WETSUIT	5 mm	MAN S/2	LK486502	199,99	179,99	159,99	299,99
MEDAS TWO-PIECE WETSUIT	5 mm	MAN M/3	LK486503	199,99	179,99	159,99	299,99
MEDAS TWO-PIECE WETSUIT	5 mm	MAN L/4	LK486504	199,99	179,99	159,99	299,99
MEDAS TWO-PIECE WETSUIT	5 mm	MAN XL/5	LK486505	199,99	179,99	159,99	299,99
MEDAS TWO-PIECE WETSUIT	5 mm	MAN 2XL/6	LK486506	199,99	179,99	159,99	299,99
MEDAS TWO-PIECE WETSUIT	5 mm	LADY XS/1	LK486401	199,99	179,99	159,99	299,99
MEDAS TWO-PIECE WETSUIT	5 mm	LADY S/2	LK486402	199,99	179,99	159,99	299,99
MEDAS TWO-PIECE WETSUIT	5 mm	LADY M/3	LK486403	199,99	179,99	159,99	299,99
MEDAS TWO-PIECE WETSUIT	5 mm	LADY L/4	LK486404	199,99	179,99	159,99	299,99
MEDAS TWO-PIECE WETSUIT	5 mm	LADY XL/5	LK486405	199,99	179,99	159,99	299,99

# FREE

## TWO-PIECE WETSUIT 3.5 mm

This two-piece wetsuit has been specially conceived for free diving. Designed to facilitate penetration into the water, it features a very smooth outer surface made of neoprene that has undergone

the "Second Skin" treatment, for greatly reduced friction in the water. The low-waist pants without shoulder straps do not apply pressure to the chest and promote effective ventilation.

THICKNESS 3.5 MM | TWO-PIECE WETSUIT | SECOND SKIN SMOOTH NEOPRENE | X-THERMIC MATERIAL LINING



### TECHNICAL FEATURES



SINGLE-PIECE UNDERARM SECTION TO IMPROVE ARM EXTENSION



DOUBLE VELCRO SYSTEM



PRODUCT	THK	SIZE	CODE	DLR €	10%	SEASONAL ORDER 20%	RRP €
FREE TWO-PIECE WETSUIT	3.5 mm	MAN XS/1	LF451001	287,49	258,74	229,99	449,99
FREE TWO-PIECE WETSUIT	3.5 mm	MAN S/2	LF451002	287,49	258,74	229,99	449,99
FREE TWO-PIECE WETSUIT	3.5 mm	MAN M/3	LF451003	287,49	258,74	229,99	449,99
FREE TWO-PIECE WETSUIT	3.5 mm	MAN L/4	LF451004	287,49	258,74	229,99	449,99
FREE TWO-PIECE WETSUIT	3.5 mm	MAN XL/5	LF451005	287,49	258,74	229,99	449,99
FREE TWO-PIECE WETSUIT	3.5 mm	LADY XS/1	LF451101	287,49	258,74	229,99	449,99
FREE TWO-PIECE WETSUIT	3.5 mm	LADY S/2	LF451102	287,49	258,74	229,99	449,99
FREE TWO-PIECE WETSUIT	3.5 mm	LADY M/3	LF451103	287,49	258,74	229,99	449,99
FREE TWO-PIECE WETSUIT	3.5 mm	LADY L/4	LF451104	287,49	258,74	229,99	449,99



# MOREA

## MONOPIECE WETSUIT 3 mm

The Morea is a 3 mm neoprene one-piece without a hood, sporting long sleeves and pants, perfect for

warm waters, snorkeling, swimming, tropical seas and for any aquatic sport.

THICKNESS  
3 MM

BACK  
ZIP

JUNIOR SIZES  
AVAILABLE

MIXED ULTRASPAN  
MATERIAL

CE >22° C  
>71.6° F  
CE CERTIFICATION  
SURFACE WETSUIT  
EN 14225-1:2017: D



  
PREMIUM  
ULTRA STRETCH  
NEOPRENE  
ON ARMS

  
PREMIUM  
ULTRA STRETCH  
NEOPRENE  
ON LEGS

### TECHNICAL FEATURES

- 3-mm neoprene with Ultraspans ends on the arms and legs.
- Rubberized neoprene on the chest and protection on the knees.



PRODUCT	THK	SIZE	CODE	DLR €	10%	SEASONAL ORDER 20%	RRP €
MOREA MONOPIECE BLACK/BLUE	3 mm	MAN S/2	LU476002	114,99	103,49	91,99	184,99
MOREA MONOPIECE BLACK/BLUE	3 mm	MAN M/3	LU476003	114,99	103,49	91,99	184,99
MOREA MONOPIECE BLACK/BLUE	3 mm	MAN L/4	LU476004	114,99	103,49	91,99	184,99
MOREA MONOPIECE BLACK/BLUE	3 mm	MAN XL/5	LU476005	114,99	103,49	91,99	184,99
MOREA MONOPIECE BLACK/BLUE	3 mm	MAN 2XL/6	LU476006	114,99	103,49	91,99	184,99
MOREA MONOPIECE BLACK/TURQUOISE	3 mm	LADY XS/1	LU476501	114,99	103,49	91,99	184,99
MOREA MONOPIECE BLACK/TURQUOISE	3 mm	LADY S/2	LU476502	114,99	103,49	91,99	184,99
MOREA MONOPIECE BLACK/TURQUOISE	3 mm	LADY M/3	LU476503	114,99	103,49	91,99	184,99
MOREA MONOPIECE BLACK/TURQUOISE	3 mm	LADY L/4	LU476504	114,99	103,49	91,99	184,99
MOREA MONOPIECE BLACK/TURQUOISE	3 mm	LADY XL/5	LU476505	114,99	103,49	91,99	184,99
MOREA MONOPIECE JR	3 mm	JR 3/4Y	LU476611	102,49	92,24	81,99	164,99
MOREA MONOPIECE JR	3 mm	JR 5/6Y	LU476612	102,49	92,24	81,99	164,99
MOREA MONOPIECE JR	3 mm	JR 6/7Y	LU476601	102,49	92,24	81,99	164,99
MOREA MONOPIECE JR	3 mm	JR 8/9Y	LU476602	102,49	92,24	81,99	164,99
MOREA MONOPIECE JR	3 mm	JR 10/11Y	LU476603	102,49	92,24	81,99	164,99
MOREA MONOPIECE JR	3 mm	JR 12/13Y	LU476604	102,49	92,24	81,99	164,99
MOREA MONOPIECE JR	3 mm	JR 13/14Y	LU476605	102,49	92,24	81,99	164,99

/ SHORTY WETSUITS

# LUI, LEI

## MONOPIECE WETSUIT 2.5 mm

THICKNESS  
2.5 MM

FRONT  
ZIP

CE >22° C  
>71.6° F  
CE CERTIFICATION  
SURFACE WETSUIT  
EN 14225-1:2017: D



### TECHNICAL FEATURES

- Separate anatomical cuts for both men and women
- Front zip entry for easier donning
- YKK zipper and Aquastop under zip lining
- Aquastop wrist and ankle seals limit water exchange
- Pre-shaped legs improve flexibility for easy kicking

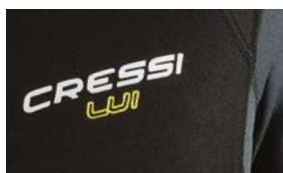

COLOR	THK	SIZE	CODE	DLR €	10%	SEASONAL ORDER 20%	RRP €
BLACK/YELLOW	2.5 mm	MAN S/2	LU479002	112,49	101,24	89,99	179,99
BLACK/YELLOW	2.5 mm	MAN M/3	LU479003	112,49	101,24	89,99	179,99
BLACK/YELLOW	2.5 mm	MAN L/4	LU479004	112,49	101,24	89,99	179,99
BLACK/YELLOW	2.5 mm	MAN XL/5	LU479005	112,49	101,24	89,99	179,99
BLACK/YELLOW	2.5 mm	MAN 2XL/6	LU479006	112,49	101,24	89,99	179,99
BLACK/YELLOW	2.5 mm	MAN 3XL/7	LU479007	112,49	101,24	89,99	179,99
BLACK/PINK	2.5 mm	LADY XS/1	LU478001	112,49	101,24	89,99	179,99
BLACK/PINK	2.5 mm	LADY S/2	LU478002	112,49	101,24	89,99	179,99
BLACK/PINK	2.5 mm	LADY M/3	LU478003	112,49	101,24	89,99	179,99
BLACK/PINK	2.5 mm	LADY L/4	LU478004	112,49	101,24	89,99	179,99
BLACK/PINK	2.5 mm	LADY XL/5	LU478005	112,49	101,24	89,99	179,99

# SKIN

## FULLSUIT 1 mm

Crafted from 1 mm material (86% Polyester / 14% Spandex), the Skin is a versatile and a must-have fullsuit for traveling divers. The high-stretch material is effortless to swim in and naturally conforms to the body to reduce drag. The Skin provides UV protection on the surface and just the warmth needed for extended snorkeling or diving sessions in tropical waters. A long front zip makes the Skin easy to put on and the suit easily layers under thicker dive wear.

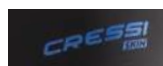

THICKNESS  
1 MM

FRONT  
ZIP

86% POLYESTER  
14% SPANDEX

### TECHNICAL FEATURES

- High-stretch 1 mm material easy to swim in
- Heel straps providing a secure fit
- Easy to don with front-entry zipper



PRODUCT	THK	SIZE	CODE	DLR €	10%	SEASONAL ORDER 20%	RRP €
BLACK/BLUE	1 mm	MAN S/2	WDG050202	47,49	42,74	37,99	75,99
BLACK/BLUE	1 mm	MAN M/3	WDG050203	47,49	42,74	37,99	75,99
BLACK/BLUE	1 mm	MAN L/4	WDG050204	47,49	42,74	37,99	75,99
BLACK/BLUE	1 mm	MAN XL/5	WDG050205	47,49	42,74	37,99	75,99
BLACK/BLUE	1 mm	MAN 2XL/6	WDG050206	47,49	42,74	37,99	75,99
BLACK/PINK	1 mm	LADY XS/1	WDG050401	47,49	42,74	37,99	75,99
BLACK/PINK	1 mm	LADY S/2	WDG050402	47,49	42,74	37,99	75,99
BLACK/PINK	1 mm	LADY M/3	WDG050403	47,49	42,74	37,99	75,99
BLACK/PINK	1 mm	LADY L/4	WDG050404	47,49	42,74	37,99	75,99
BLACK/PINK	1 mm	LADY XL/5	WDG050405	47,49	42,74	37,99	75,99



# LIDO

NEW 2023

THICKNESS  
2 MM

FRONT  
ZIP

## MONOPIECE WETSUIT 2 mm

The easy-entry, front zipper placement of the Lido makes it effortless to put on. It is perfect for snorkeling in tropical waters, swimming, surfing and other activities. Highly flexible 2 mm Neoprene and a flattering cut conform easily to most body shapes for a great fit. The absence of seams under

the arms prevents the intrusion of water. Fabric cuts are anatomical for both men and women. The legs and sleeves are finished with a simple, economic, and reliable Overlock cuff.

### TECHNICAL FEATURES

- Full front-zip wetsuit.
- Designed and created using innovative and patented manufacturing technology.
- Double-lined neoprene for durability and warmth.
- YKK zippers for durability - Front zip entry for easier donning.
- Always a comfortable fit.



PRODUCT	THK	SIZE	CODE	DLR €	10%	SEASONAL ORDER 20%	RRP €
LIDO MONOPIECE BLACK/BLUE	2 mm	MAN XS/1	XLV452001	97,49	87,74	77,99	154,99
LIDO MONOPIECE BLACK/BLUE	2 mm	MAN S/2	XLV452002	97,49	87,74	77,99	154,99
LIDO MONOPIECE BLACK/BLUE	2 mm	MAN M/3	XLV452003	97,49	87,74	77,99	154,99
LIDO MONOPIECE BLACK/BLUE	2 mm	MAN L/4	XLV452004	97,49	87,74	77,99	154,99
LIDO MONOPIECE BLACK/BLUE	2 mm	MAN XL/5	XLV452005	97,49	87,74	77,99	154,99
LIDO MONOPIECE BLACK/BLUE	2 mm	MAN 2XL/6	XLV452006	97,49	87,74	77,99	154,99
LIDO MONOPIECE BLACK/BLUE	2 mm	MAN 3XL/7	XLV452007	97,49	87,74	77,99	154,99
LIDO MONOPIECE BLACK/BLUE	2 mm	MAN 4XL/8	XLV452008	97,49	87,74	77,99	154,99
LIDO MONOPIECE BLACK/AQUAMARINE	2 mm	LADY XS/1	XLV458541	97,49	87,74	77,99	154,99
LIDO MONOPIECE BLACK/AQUAMARINE	2 mm	LADY S/2	XLV458542	97,49	87,74	77,99	154,99
LIDO MONOPIECE BLACK/AQUAMARINE	2 mm	LADY M/3	XLV458543	97,49	87,74	77,99	154,99
LIDO MONOPIECE BLACK/AQUAMARINE	2 mm	LADY L/4	XLV458544	97,49	87,74	77,99	154,99
LIDO MONOPIECE BLACK/AQUAMARINE	2 mm	LADY XL/5	XLV458545	97,49	87,74	77,99	154,99
LIDO MONOPIECE BLACK/AQUAMARINE	2 mm	LADY 2XL/6	XLV458546	97,49	87,74	77,99	154,99

# ALTUM

## 100% HIGH-STRETCH SHORTY WETSUIT 3 mm

Stylish, warm and versatile, the Fast can be used in the widest range of temperate waters. Durable 3 mm neoprene, pre-shaped legs improve flexibility

for easier kicking and anti-abrasion reinforcement on the knees.

THICKNESS  
3 mm

BACK  
ZIP

ULTRAELASTIC  
FABRIC

CE >22° C  
>71.6° F  
CE CERTIFICATION  
SURFACE WETSUIT  
EN 14225-1:2017. D



PRODUCT	THK	SIZE	CODE	DLR €	10%	SEASONAL ORDER 20%	RRP €
ALTUM SHORTY WETSUIT BLACK/RED	3 mm	MAN S/2	XLV436022	82,49	74,24	65,99	131,99
ALTUM SHORTY WETSUIT BLACK/RED	3 mm	MAN M/3	XLV436023	82,49	74,24	65,99	131,99
ALTUM SHORTY WETSUIT BLACK/RED	3 mm	MAN L/4	XLV436024	82,49	74,24	65,99	131,99
ALTUM SHORTY WETSUIT BLACK/RED	3 mm	MAN XL/5	XLV436025	82,49	74,24	65,99	131,99
ALTUM SHORTY WETSUIT BLACK/RED	3 mm	MAN 2XL/6	XLV436026	82,49	74,24	65,99	131,99
ALTUM SHORTY WETSUIT BLACK/RED	3 mm	MAN 3XL/7	XLV436027	82,49	74,24	65,99	131,99
ALTUM SHORTY WETSUIT BLACK/PINK	3 mm	LADY XS/1	XLV436061	82,49	74,24	65,99	131,99
ALTUM SHORTY WETSUIT BLACK/PINK	3 mm	LADY S/2	XLV436062	82,49	74,24	65,99	131,99
ALTUM SHORTY WETSUIT BLACK/PINK	3 mm	LADY M/3	XLV436063	82,49	74,24	65,99	131,99
ALTUM SHORTY WETSUIT BLACK/PINK	3 mm	LADY L/4	XLV436064	82,49	74,24	65,99	131,99
ALTUM SHORTY WETSUIT BLACK/PINK	3 mm	LADY XL/5	XLV436065	82,49	74,24	65,99	131,99



# MED X

## SHORTY WETSUIT 2.5 mm

This is the new version of the most known Cressi one-piece wetsuit for water sports and tropical seas. It's presented with a new pattern, and new captivating aesthetic. It's available in man, woman and kids version.

Monoshort without hook, with short pants and sleeves in double fodder neoprene 2.5mm.

It's ideal to snorkeling, swimming, tropical seas and any kind of water sport.

Flat neoprene on the chest area to obtain more elasticity. There are insertions in flat neoprene on wrists and legs to minimize water filtrations.

YKK® 8 pitch dorsal zip with Velcro® closing.

THICKNESS  
2.5 MM

BACK  
ZIP

JUNIOR SIZES  
AVAILABLE

 >22° C  
>71.6° F  
CE CERTIFICATION  
SURFACE WETSUIT  
EN 14225-1:2017: D



### TECHNICAL FEATURES

- Rear zip.
- Adjustable collar with Velcro closure.
- Children's sizes available.



PRODUCT	THK	SIZE	CODE	DLR €	10%	SEASONAL ORDER 20%	RRP €
MED X SHORTY WETSUIT	2.5 mm	MAN XS/1	LV437001	64,99	58,49	51,99	104,99
MED X SHORTY WETSUIT	2.5 mm	MAN S/2	LV437002	64,99	58,49	51,99	104,99
MED X SHORTY WETSUIT	2.5 mm	MAN M/3	LV437003	64,99	58,49	51,99	104,99
MED X SHORTY WETSUIT	2.5 mm	MAN L/4	LV437004	64,99	58,49	51,99	104,99
MED X SHORTY WETSUIT	2.5 mm	MAN XL/5	LV437005	64,99	58,49	51,99	104,99
MED X SHORTY WETSUIT	2.5 mm	MAN 2XL/6	LV437006	64,99	58,49	51,99	104,99
MED X SHORTY WETSUIT	2.5 mm	LADY XS/1	LV437501	64,99	58,49	51,99	104,99
MED X SHORTY WETSUIT	2.5 mm	LADY S/2	LV437502	64,99	58,49	51,99	104,99
MED X SHORTY WETSUIT	2.5 mm	LADY M/3	LV437503	64,99	58,49	51,99	104,99
MED X SHORTY WETSUIT	2.5 mm	LADYL/4	LV437504	64,99	58,49	51,99	104,99
MED X SHORTY WETSUIT	2.5 mm	JR 3XS/(age 3/4)	LV438011	53,13	47,82	42,50	84,99
MED X SHORTY WETSUIT	2.5 mm	JR 2XS/(age 5/6)	LV438012	53,13	47,82	42,50	84,99
MED X SHORTY WETSUIT	2.5 mm	JR XS/(age 6/7)	LV438001	53,13	47,82	42,50	84,99
MED X SHORTY WETSUIT	2.5 mm	JR S/(age 8/9)	LV438002	53,13	47,82	42,50	84,99
MED X SHORTY WETSUIT	2.5 mm	JR M/(age10/11)	LV438003	53,13	47,82	42,50	84,99
MED X SHORTY WETSUIT	2.5 mm	JRL/(age12/13)	LV438004	53,13	47,82	42,50	84,99
MED X SHORTY WETSUIT	2.5 mm	JR XL/(age 14/15)	LV438005	53,13	47,82	42,50	84,99

# PLAYA

## SHORTY WETSUIT 2.5 mm

Hoodless one piece with shorts and short sleeves, in 2.5-mm double-lined neoprene. Plastic YKK® zipper that's impervious to external agents, located on the front to make it easier to put on the suit. Flat stitching with scratch-resistant thread and sleeves and legs hemmed with neoprene for

improved durability and comfort. Playa is perfect for snorkeling, swimming, sailing, and water sports in general.



THICKNESS  
2.5 MM

FRONT  
ZIP

>22° C  
>71.6° F  
CE CERTIFICATION  
SURFACE WETSUIT  
EN 14225-1:2017: D



### TECHNICAL FEATURES

- Separate anatomical cuts for both men and women
- Single neoprene cuff seals
- Front zip entry for easier donning



PRODUCT	THK	SIZE	CODE	DLR €	10%	SEASONAL ORDER 20%	RRP €
PLAYA SHORTY WETSUIT BLACK/RED	2.5 mm	MAN XS/1	LV445001	74,99	67,49	59,99	119,99
PLAYA SHORTY WETSUIT BLACK/RED	2.5 mm	MAN S/2	LV445002	74,99	67,49	59,99	119,99
PLAYA SHORTY WETSUIT BLACK/RED	2.5 mm	MAN M/3	LV445003	74,99	67,49	59,99	119,99
PLAYA SHORTY WETSUIT BLACK/RED	2.5 mm	MAN L/4	LV445004	74,99	67,49	59,99	119,99
PLAYA SHORTY WETSUIT BLACK/RED	2.5 mm	MAN XL/5	LV445005	74,99	67,49	59,99	119,99
PLAYA SHORTY WETSUIT BLACK/RED	2.5 mm	MAN 2XL/6	LV445006	74,99	67,49	59,99	119,99
PLAYA SHORTY WETSUIT BLACK/PINK	2.5 mm	LADY XS/1	LV446001	74,99	67,49	59,99	119,99
PLAYA SHORTY WETSUIT BLACK/PINK	2.5 mm	LADY S/2	LV446002	74,99	67,49	59,99	119,99
PLAYA SHORTY WETSUIT BLACK/PINK	2.5 mm	LADY M/3	LV446003	74,99	67,49	59,99	119,99
PLAYA SHORTY WETSUIT BLACK/PINK	2.5 mm	LADY L/4	LV446004	74,99	67,49	59,99	119,99
PLAYA SHORTY WETSUIT BLACK/PINK	2.5 mm	LADY XL/5	LV446005	74,99	67,49	59,99	119,99



# LIDO

## SHORTY WETSUIT 2 mm

Highly flexible 2 mm neoprene and a flattering cut conform easily to most body shapes for a great fit.

THICKNESS 2 MM | FRONT ZIP | JUNIOR SIZES AVAILABLE



### TECHNICAL FEATURES

- Separate anatomical cuts for both men and women
- Double-lined neoprene
- Front zip entry for easier donning



PRODUCT	THK	SIZE	CODE	DLR €	10%	SEASONAL ORDER 20%	RRP €
LIDO SHORTY BLACK/BLUE	2 mm	MAN XS/1	LV455001	49.99	44.99	39.99	79.99
LIDO SHORTY BLACK/BLUE	2 mm	MAN S/2	LV455002	49.99	44.99	39.99	79.99
LIDO SHORTY BLACK/BLUE	2 mm	MAN M/3	LV455003	49.99	44.99	39.99	79.99
LIDO SHORTY BLACK/BLUE	2 mm	MAN L/4	LV455004	49.99	44.99	39.99	79.99
LIDO SHORTY BLACK/BLUE	2 mm	MAN XL/5	LV455005	49.99	44.99	39.99	79.99
LIDO SHORTY BLACK/BLUE	2 mm	MAN 2XL/6	LV455006	49.99	44.99	39.99	79.99
LIDO SHORTY BLACK/BLUE	2 mm	MAN 3XL/7	LV455007	49.99	44.99	39.99	79.99
LIDO SHORTY BLACK/AQUAMARINE	2 mm	LADY XS/1	LV457001	49.99	44.99	39.99	79.99
LIDO SHORTY BLACK/AQUAMARINE	2 mm	LADY S/2	LV457002	49.99	44.99	39.99	79.99
LIDO SHORTY BLACK/AQUAMARINE	2 mm	LADY M/3	LV457003	49.99	44.99	39.99	79.99
LIDO SHORTY BLACK/AQUAMARINE	2 mm	LADY L/4	LV457004	49.99	44.99	39.99	79.99
LIDO SHORTY BLACK/AQUAMARINE	2 mm	LADY XL/5	LV457005	49.99	44.99	39.99	79.99
LIDO SHORTY BLACK/BLUE	2 mm	JR XS (age 6/7)	LV458001	43.74	39.37	34.99	74.99
LIDO SHORTY BLACK/BLUE	2 mm	JR S (age 8/9)	LV458002	43.74	39.37	34.99	74.99
LIDO SHORTY BLACK/BLUE	2 mm	JR M (age 10/11)	LV458003	43.74	39.37	34.99	74.99
LIDO SHORTY BLACK/BLUE	2 mm	JR L (age 12/13)	LV458004	43.74	39.37	34.99	74.99

# DIVER

## MONOPIECE WETSUIT 7 mm, 5 mm

AVAILABLE IN TWO THICKNESS: 7 OR 5 MM

FRONT ZIP

JUNIOR SIZES AVAILABLE

10-18° C  
50-64,4° F  
CE CERTIFICATION  
DIVING WETSUIT  
EN 14225-1:2017: B

7 mm  
CE

16-24° C  
60,8-75,2° F  
CE CERTIFICATION  
DIVING WETSUIT  
EN 14225-1:2017: C

5 mm  
CE

All-in-one suit available in 5 and 7 mm double lined neoprene, with incorporated hood and front zip fastening which has recently been up dated, both technically and aesthetically. Traditional all-in-one suit for dives in warm waters, very easy to put on and take off, designed to offer great freedom of movement. The legs are pre-shaped to allow the natural, typical bending of the limbs when swimming. The front zip stretches from the waist to the right cheek.

A smooth neoprene seal runs along the edge of the facial profile of the hood thus limiting water infiltration and increasing comfort. There are reinforced anti-wear pads on the knees. At the wrists the seal is guaranteed by double lined cuffs, the same solution is also used at the ankles, in this case, however, they have handy zips to help the user put on and take off the suit. Available in men's, women's and children's versions.

### WHO IT IS FOR

Diver is a wetsuit that has been designed for scuba diving in warm waters, like those of the Mediterranean during the summer months, or those of the tropics during the winter seasons. Quick and easy to put on and take off, it offers great freedom of movement and is much appreciated by diving guides and by those who have to perform several dives on the same day.



REINFORCED NEOPRENE



ANKLE ZIPPER



THK	SIZE	CODE	DLR €	10%	SEASONAL ORDER 20%	RRP €
5 mm	MAN S/2	LU489502	174,99	157,49	139,99	269,99
5 mm	MAN M/3	LU489503	174,99	157,49	139,99	269,99
5 mm	MAN L/4	LU489504	174,99	157,49	139,99	269,99
5 mm	MAN XL/5	LU489505	174,99	157,49	139,99	269,99
5 mm	MAN 2XL/6	LU489506	174,99	157,49	139,99	269,99
5 mm	MAN 3XL/7	LU489507	174,99	157,49	139,99	269,99
5 mm	LADY XS/1	LU488001	174,99	157,49	139,99	269,99
5 mm	LADY S/2	LU488002	174,99	157,49	139,99	269,99
5 mm	LADY M/3	LU488003	174,99	157,49	139,99	269,99
5 mm	LADY L/4	LU488004	174,99	157,49	139,99	269,99
5 mm	LADY XL/5	LU488005	174,99	157,49	139,99	269,99
5 mm	JR 3X5 (age 8/9)	LU489001	149,99	134,99	119,99	239,99
5 mm	JR 2X5 (age10/11)	LU489002	149,99	134,99	119,99	239,99
5 mm	JR XS (age12/13)	LU489003	149,99	134,99	119,99	239,99

THK	SIZE	CODE	DLR €	10%	SEASONAL ORDER 20%	RRP €
7 mm	MAN S/2	LU489602	199,99	179,99	159,99	309,99
7 mm	MAN M/3	LU489603	199,99	179,99	159,99	309,99
7 mm	MAN L/4	LU489604	199,99	179,99	159,99	309,99
7 mm	MAN XL/5	LU489605	199,99	179,99	159,99	309,99
7 mm	MAN 2XL/6	LU489606	199,99	179,99	159,99	309,99
7 mm	LADY XS/1	LU489701	199,99	179,99	159,99	309,99
7 mm	LADY S/2	LU489702	199,99	179,99	159,99	309,99
7 mm	LADY M/3	LU489703	199,99	179,99	159,99	309,99
7 mm	LADY L/4	LU489704	199,99	179,99	159,99	309,99
7 mm	LADY XL/5	LU489705	199,99	179,99	159,99	309,99



# ENDURANCE

## MONOPIECE WETSUIT 5 mm

5 mm one piece double lined neoprene diving suit. Conceived for intensive use in tepid waters. Easy to put on thanks to its YKK zippers: a heavy duty one on the front and two on the ankles. In the areas most exposed to wear on the part of the jacket,

such as the belly and the shoulders, "Xdiamond", a special neoprene ensuring superior resistance to abrasion, is used. Special neoprene also covers the back and the knees, which are subjected to high stresses.

THICKNESS  
5 MM

FRONT  
ZIP

JUNIOR SIZES  
AVAILABLE

16-24° C  
60.8-75.2° F  
CE CERTIFICATION  
DIVING WETSUIT  
EN 14225-1:2017: C

5 mm  
CE



### TECHNICAL FEATURES

- Shoulder, waist, back and knee reinforced pads with X-diamond ultraresistant material
- YKK front zip
- Ankle zipper

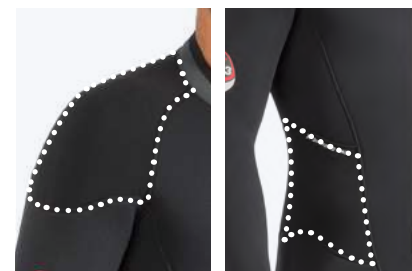

PRODUCT	THK	SIZE	CODE	DLR €	10%	SEASONAL ORDER 20%	RRP €
ENDURANCE MONO. WETSUIT	5 mm	MAN S/2	JLV495002	156,24	140,62	124,99	249,99
ENDURANCE MONO. WETSUIT	5 mm	MAN M/3	JLV495003	156,24	140,62	124,99	249,99
ENDURANCE MONO. WETSUIT	5 mm	MAN L/4	JLV495004	156,24	140,62	124,99	249,99
ENDURANCE MONO. WETSUIT	5 mm	MAN XL/5	JLV495005	156,24	140,62	124,99	249,99
ENDURANCE MONO. WETSUIT	5 mm	MAN 2XL/6	JLV495006	156,24	140,62	124,99	249,99
ENDURANCE MONO. WETSUIT	5 mm	LADY XS/1	JLV497001	156,24	140,62	124,99	249,99
ENDURANCE MONO. WETSUIT	5 mm	LADY S/2	JLV497002	156,24	140,62	124,99	249,99
ENDURANCE MONO. WETSUIT	5 mm	LADY M/3	JLV497003	156,24	140,62	124,99	249,99
ENDURANCE MONO. WETSUIT	5 mm	LADY L/4	JLV497004	156,24	140,62	124,99	249,99

# ENDURANCE

## SHORTY WETSUIT 3 mm

3 mm one piece shorty wetsuit. Easy to put on thanks to its YKK zipper: a heavy duty one on the front. In the areas most exposed to wear on the part of the jacket, such as the belly and the shoulders, "Xdiamond", a special neoprene ensuring superior resistance to abrasion, is used. Special neoprene also covers the back, which is subjected to high stresses.

THICKNESS  
3 MM

FRONT  
ZIP

JUNIOR SIZES  
AVAILABLE

>22° C  
>71.6° F  
CE CERTIFICATION  
DIVING WETSUIT  
EN 14225-1:2017: D



### TECHNICAL FEATURES

- Shoulder, waist, back reinforced pads with X-diamond ultraresistant material
- YKK front zip



PRODUCT	THK	SIZE	CODE	DLR €	10%	SEASONAL ORDER 20%	RRP €
ENDURANCE SHORTY WETSUIT	3 mm	MAN S/2	JLV475002	81.24	73.12	64.99	124.99
ENDURANCE SHORTY WETSUIT	3 mm	MAN M/3	JLV475003	81.24	73.12	64.99	124.99
ENDURANCE SHORTY WETSUIT	3 mm	MAN L/4	JLV475004	81.24	73.12	64.99	124.99
ENDURANCE SHORTY WETSUIT	3 mm	MAN XL/5	JLV475005	81.24	73.12	64.99	124.99
ENDURANCE SHORTY WETSUIT	3 mm	MAN 2XL/6	JLV475006	81.24	73.12	64.99	124.99
ENDURANCE SHORTY WETSUIT	3 mm	LADY XS/1	JLV477001	81.24	73.12	64.99	124.99
ENDURANCE SHORTY WETSUIT	3 mm	LADY S/2	JLV477002	81.24	73.12	64.99	124.99
ENDURANCE SHORTY WETSUIT	3 mm	LADY M/3	JLV477003	81.24	73.12	64.99	124.99
ENDURANCE SHORTY WETSUIT	3 mm	LADY L/4	JLV477004	81.24	73.12	64.99	124.99





QUICK DRY FABRIC

50+ UV PROTECTION

HIGHLY STRETCHABLE

SHORT & LONG SLEEVE OPTIONS AVAILABLE

# DIVE CENTER

## LONG SLEEVES RASHGUARD

Ideal for diving, snorkeling, surfing and other water sports, this rash guard helps protect the torso from equipment abrasion and delivers SPF 40 protection from harmful UV rays. Available in a full range of

men's, women's, the quality 190 gms/m<sup>2</sup> material is high-stretch for easier swimming and is styled and cut for a flattering fit.



### TECHNICAL FEATURES

- This protective t-shirt is made from special, stretchy material
- It offers excellent protection from the sun, wind and low temperatures either in the water or when dry
- Flat-lock stitching for comfort and durability
- Ideal for diving, snorkeling, surfing and other water sports.
- White pad to write name or number



MAN	(1) CHEST	(2) LENGTH
2XS	36 cm (14 in)	54 cm (21 in)
XS	40 cm (16 in)	57.5 cm (23 in)
S	40 cm (16 in)	59 cm (23 in)
M	45.5 cm (18 in)	62 cm (24 in)
L	48.8 cm (19 in)	66 cm (26 in)
XL	52.5 cm (21 in)	67.5 cm (27 in)
2XL	55.5 cm (22 in)	70.5 cm (28 in)
3XL	58 cm (23 in)	73.5 cm (29 in)
4XL	60.5 cm (24 in)	76 cm (30 in)

LADY	(1) CHEST	(2) LENGTH
2XS	35 cm (14 in)	50 cm (20 in)
XS	38 cm (15 in)	54 cm (21 in)
S	40.5 cm (16 in)	56.5 cm (22 in)
M	42 cm (17 in)	56.5 cm (22 in)
L	43.5 cm (17 in)	59 cm (23 in)
XL	44 cm (17 in)	61 cm (24 in)
2XL	45.7 cm (18 in)	63.5 cm (25 in)

PRODUCT	SIZE	CODE	DLR €	10%	SEASONAL ORDER 20%	RRP €
DIVE CENTER RASH GUARD LONG/SL BLACK	MAN S/2 (48)	JLW478502	29.99	26.99	23.99	47.99
DIVE CENTER RASH GUARD LONG/SL BLACK	MAN M/3 (50)	JLW478503	29.99	26.99	23.99	47.99
DIVE CENTER RASH GUARD LONG/SL BLACK	MAN L/4 (52)	JLW478504	29.99	26.99	23.99	47.99
DIVE CENTER RASH GUARD LONG/SL BLACK	MAN XL/5 (54)	JLW478505	29.99	26.99	23.99	47.99
DIVE CENTER RASH GUARD LONG/SL BLACK	MAN 2XL/6 (56)	JLW478506	29.99	26.99	23.99	47.99
DIVE CENTER RASH GUARD LONG/SL BLACK	MAN 3XL/7 (58)	JLW478507	29.99	26.99	23.99	47.99
DIVE CENTER RASH GUARD LONG/SL BLACK	LADY XS/1 (36)	JLW478601	29.99	26.99	23.99	47.99
DIVE CENTER RASH GUARD LONG/SL BLACK	LADY S/2 (38)	JLW478602	29.99	26.99	23.99	47.99
DIVE CENTER RASH GUARD LONG/SL BLACK	LADY M/3 (40)	JLW478603	29.99	26.99	23.99	47.99
DIVE CENTER RASH GUARD LONG/SL BLACK	LADY L/4 (42)	JLW478604	29.99	26.99	23.99	47.99
DIVE CENTER RASH GUARD LONG/SL BLACK	LADY XL/5 (44)	JLW478605	29.99	26.99	23.99	47.99





QUICK DRY FABRIC

50+ UV PROTECTION

HIGHLY STRETCHABLE

SHORT & LONG SLEEVE OPTIONS AVAILABLE

# DIVE CENTER

## SHORT SLEEVES RASHGUARD

Ideal for diving, snorkeling, surfing and other water sports, this rash guard helps protect the torso from equipment abrasion and delivers 50+ protection from harmful UV rays. Available in a full range of

men's, women's, the quality 190 gms/m<sup>2</sup> material is high-stretch for easier swimming and is styled and cut for a flattering fit.



WRITABLE WHITE PAD



### TECHNICAL FEATURES

- This protective t-shirt is made from special, stretchy material
- It offers excellent protection from the sun, wind and low temperatures either in the water or when dry
- Flat-lock stitching for comfort and durability
- Ideal for diving, snorkeling, surfing and other water sports.
- White pad to write name or number



MAN	(1) CHEST	(2) LENGTH
2XS	36 cm (14 in)	54 cm (21 in)
XS	40 cm (16 in)	57,5 cm (23 in)
S	40 cm (16 in)	59 cm (23 in)
M	45,5 cm (18 in)	62 cm (24 in)
L	48,8 cm (19 in)	66 cm (26 in)
XL	52,5 cm (21 in)	67,5 cm (27 in)
2XL	55,5 cm (22 in)	70,5 cm (28 in)
3XL	58 cm (23 in)	73,5 cm (29 in)
4XL	60,5 cm (24 in)	76 cm (30 in)

LADY	(1) CHEST	(2) LENGTH
2XS	35 cm (14 in)	50 cm (20 in)
XS	38 cm (15 in)	54 cm (21 in)
S	40,5 cm (16 in)	56,5 cm (22 in)
M	42 cm (17 in)	56,5 cm (22 in)
L	43,5 cm (17 in)	59 cm (23 in)
XL	44 cm (17 in)	61 cm (24 in)
2XL	45,7 cm (18 in)	63,5 cm (25 in)

PRODUCT	SIZE	CODE	DLR €	10%	SEASONAL ORDER 20%	RRP €
DIVE CENTER RASH GUARD SHORT/SL BLACK	MAN S/2 (48)	JLW478302	24,99	22,49	19,99	39,99
DIVE CENTER RASH GUARD SHORT/SL BLACK	MAN M/3 (50)	JLW478303	24,99	22,49	19,99	39,99
DIVE CENTER RASH GUARD SHORT/SL BLACK	MAN L/4 (52)	JLW478304	24,99	22,49	19,99	39,99
DIVE CENTER RASH GUARD SHORT/SL BLACK	MAN XL/5 (54)	JLW478305	24,99	22,49	19,99	39,99
DIVE CENTER RASH GUARD SHORT/SL BLACK	MAN 2XL/6 (56)	JLW478306	24,99	22,49	19,99	39,99
DIVE CENTER RASH GUARD SHORT/SL BLACK	MAN 3XL/7 (58)	JLW478307	24,99	22,49	19,99	39,99
DIVE CENTER RASH GUARD SHORT/SL BLACK	LADY XS/1 (36)	JLW478401	24,99	22,49	19,99	39,99
DIVE CENTER RASH GUARD SHORT/SL BLACK	LADY S/2(38)	JLW478402	24,99	22,49	19,99	39,99
DIVE CENTER RASH GUARD SHORT/SL BLACK	LADY M/3 (40)	JLW478403	24,99	22,49	19,99	39,99
DIVE CENTER RASH GUARD SHORT/SL BLACK	LADY L/4 (42)	JLW478404	24,99	22,49	19,99	39,99
DIVE CENTER RASH GUARD SHORT/SL BLACK	LADY XL/5 (44)	JLW478405	24,99	22,49	19,99	39,99





# SWIMMING WETSUITS



# KUWAE

MULTI THICKNESS  
4+3+2 MM

BACK  
ZIP

UV  
PROTECTION

QUICK  
DRYING

HYPERSTRETCH  
NEOPRENE

12 - 18 °C  
55 - 64° F



## MULTI THICKNESS MONOPIECE WETSUIT 4+3+2 mm

The new Cressi swimming suit is inspired by the underwater caldera Kuwae, located in the Vanuatu archipelago in the South Pacific Ocean. The coral colour of the upper part of the wetsuit recalls the lava of the volcanic eruption, like the truly explosive design. This particular colour was also chosen to give the swimmer maximum visibility when in open water. Kuwae has been entirely designed with the help of sophisticated 3D software for the modelling of wetsuits, which made it possible to study the fitting of the materials and the different sizes on virtual mannequins. In this way, Cressi not only

facilitates an innovative approach to research and development, but also obtains a positive environmental impact by eliminating unnecessary sample collections.

Kuwae is the ideal wetsuit in cold water with temperatures between 12 and 18°C. The different thicknesses (2-3-4 mm) of the super-elastic materials favour buoyancy, help the swimmer to achieve a perfect trim when swimming on the surface and improve the fit in the arms/armpits, while ensuring complete freedom of movement. The striped material insert applied in the wrist area helps to move more water during the classic

freestyle stroke. The new low neckline design has been studied to avoid any friction around the neck, while maintaining a perfect seal against water infiltration.

On the inner part of the under zip panel it is possible to customize the wetsuit with your name and insert the key of any means of transport in the special pocket. The YKK back zip guarantees tightness and resistance over time: the slider is made of anti-corrosion metal material, to ensure greater sturdiness when pulling the lanyard during the closing/opening of the wetsuit.



TOP/ARMS 2 mm  
COMPLETE FREEDOM OF  
MOVEMENT

FRONT 3 mm  
COLD WATER  
PROTECTION

LEGS 4 mm  
IMPROVED BUOYANCY



### TECHNICAL FEATURES

- The ultimate swimming wetsuit
- Completely designed with a sophisticated 3d modelling software
- Graphics inspired by underwater volcanic eruption
- Maximum visibility for the swimmer when in open water
- Back zip
- Different thicknesses (2-3-4 mm)



NEW LOW NECKLINE DESIGN

PRODUCT	THK	SIZE	CODE	DLR €	10%	SEASONAL ORDER 20%	RRP €
KUWAE SWIMSUIT BLACK/RED	2/3/4mm	MAN XS/1	DG002411	274,99	247,49	219,99	419,99
KUWAE SWIMSUIT BLACK/RED	2/3/4mm	MAN S/2	DG002412	274,99	247,49	219,99	419,99
KUWAE SWIMSUIT BLACK/RED	2/3/4mm	MAN M/3	DG002413	274,99	247,49	219,99	419,99
KUWAE SWIMSUIT BLACK/RED	2/3/4mm	MAN L/4	DG002414	274,99	247,49	219,99	419,99
KUWAE SWIMSUIT BLACK/RED	2/3/4mm	MAN XL/5	DG002415	274,99	247,49	219,99	419,99
KUWAE SWIMSUIT BLACK/RED	2/3/4mm	MAN 2XL/6	DG002416	274,99	247,49	219,99	419,99
KUWAE SWIMSUIT BLACK/LILAC	2/3/4mm	LADY XS/1	DG002611	274,99	247,49	219,99	419,99
KUWAE SWIMSUIT BLACK/LILAC	2/3/4mm	LADY S/2	DG002612	274,99	247,49	219,99	419,99
KUWAE SWIMSUIT BLACK/LILAC	2/3/4mm	LADY M/3	DG002613	274,99	247,49	219,99	419,99
KUWAE SWIMSUIT BLACK/LILAC	2/3/4mm	LADY L/4	DG002614	274,99	247,49	219,99	419,99
KUWAE SWIMSUIT BLACK/LILAC	2/3/4mm	LADY XL/5	DG002615	274,99	247,49	219,99	419,99

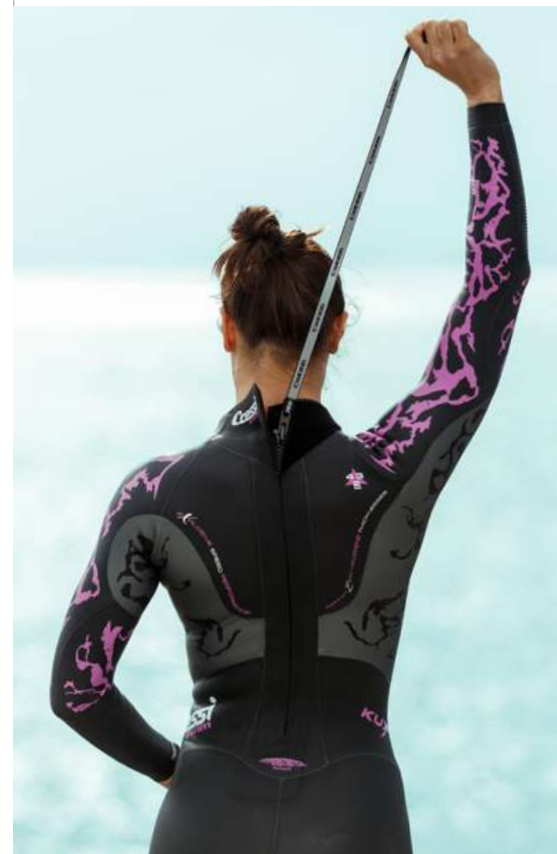



# KUWAE

NEW 2023

THICKNESS 2 MM | BACK ZIP | UV PROTECTION | QUICK DRYING | HYPERSTRETCH NEOPRENE | 18 - 26 °C | 65 - 79° F

## SWIM MONOPIECE WETSUIT 2 mm

The new Cressi swimming suit is inspired by the underwater caldera Kuwae, located in the Vanuatu archipelago in the South Pacific Ocean. The fluorescent colour of the upper part of the wetsuit recalls the lava of the volcanic eruption, as does the truly explosive design. This particular colour was also chosen to give the swimmer maximum visibility when in open water. Kuwae has been entirely designed with the help of sophisticated 3D software for the modelling of wetsuits, which made it possible to study the fitting of the materials and the different sizes on virtual mannequins. In this way, Cressi not only

facilitates an innovative approach to research and development, but also obtains a positive environmental impact by eliminating unnecessary sample collections.

Kuwae is the ideal swimming wetsuit in water temperatures between 18°C and 26°C.

The 2.0 mm high-density Hyperstretch neoprene optimizes comfort, provides UV protection, and protects swimmers against scratches while ensuring complete freedom of movement. The smooth exterior finish and the Glide Skin XT waterproof treatment guarantee exceptional hydrodynamics.

The new low neckline design has been studied to avoid any friction around the neck, while maintaining a perfect seal against water infiltration. On the inner part of the under-zip panel you can customize the wetsuit with your name and stash a key for any means of transport in the special pocket. The YKK back zip guarantees tightness and durability over time: the slider is made of anti-corrosion metal material, to ensure greater sturdiness when pulling the lanyard to zip/unzip the wetsuit.



### TECHNICAL FEATURES

- The ultimate swimming wetsuit
- Completely designed with a sophisticated 3d modelling software
- Graphics inspired by underwater volcanic eruption
- Maximum visibility for the swimmer when in open water
- Back zip

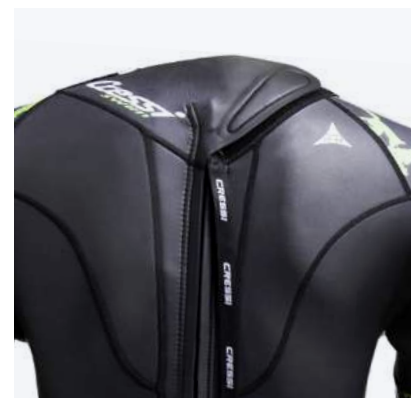

PRODUCT	THK	SIZE	CODE	DLR €	10%	SEASONAL ORDER 20%	RRP €
KUWAE SWIMSUIT BLACK/GREEN	2 mm	MAN XS/1	DG002701	212,49	191,24	169,99	329,99
KUWAE SWIMSUIT BLACK/GREEN	2 mm	MAN S/2	DG002702	212,49	191,24	169,99	329,99
KUWAE SWIMSUIT BLACK/GREEN	2 mm	MAN M/3	DG002703	212,49	191,24	169,99	329,99
KUWAE SWIMSUIT BLACK/GREEN	2 mm	MAN L/4	DG002704	212,49	191,24	169,99	329,99
KUWAE SWIMSUIT BLACK/GREEN	2 mm	MAN XL/5	DG002705	212,49	191,24	169,99	329,99
KUWAE SWIMSUIT BLACK/GREEN	2 mm	MAN 2XL/6	DG002706	212,49	191,24	169,99	329,99
KUWAE SWIMSUIT BLACK/ORANGE	2 mm	LADY XS/1	DG002801	212,49	191,24	169,99	329,99
KUWAE SWIMSUIT BLACK/ORANGE	2 mm	LADY S/2	DG002802	212,49	191,24	169,99	329,99
KUWAE SWIMSUIT BLACK/ORANGE	2 mm	LADY M/3	DG002803	212,49	191,24	169,99	329,99
KUWAE SWIMSUIT BLACK/ORANGE	2 mm	LADY L/4	DG002804	212,49	191,24	169,99	329,99
KUWAE SWIMSUIT BLACK/ORANGE	2 mm	LADY XL/5	DG002805	212,49	191,24	169,99	329,99

# KARUA

NEW 2023

MULTI THICKNESS  
3+2 MM

BACK  
ZIP

UV  
PROTECTION

QUICK  
DRYING

ULTRASTRETCH  
NEOPRENE

18 - 26 ° C  
65 - 79° F



## MULTI THICKNESS MONOPIECE WETSUIT 3+2 mm

The new Cressi hybrid wetsuit is inspired by the underwater caldera Karua, located in the Vanuatu archipelago in the South Pacific Ocean. The graphics at the wetsuit's sleeves recall the lava of the volcanic eruption. The fluorescent-coloured sleeves, the upper back panel, and the ankles give maximum visibility when in open water. Karua has been entirely designed with the help of sophisticated 3D software for the modelling of wetsuits, which made it possible to study the fitting of the materials and the different sizes on virtual mannequins. In this way, Cressi not only facilitates an innovative approach to research

and development, but also obtains a positive environmental impact by eliminating unnecessary sample collections. Karua is an ideal wetsuit for all kinds of watersport activities in water temperatures between 18 and 26°C. Both the exterior and interior are smooth, comfortable and durable nylon-covered 3mm Ultrastretch neoprene, which provides a great flexibility, UV protection, and protects swimmers against scratches while ensuring complete freedom of movement. The perfect thin hybrid wetsuit for those who are looking for a suit for swimming, snorkelling, surfing, paddling,

canyoning, and all other experiences in the water. The new low neckline design with the 2mm Glide Skin XT neoprene has been studied to avoid any friction around the neck, while maintaining a perfect seal against water infiltration. On the inner part of the under-zip panel, you can customize the wetsuit with your name and stash a key for any means of transport in the special pocket. The YKK back zip guarantees tightness and durability over time: the slider is made of anti-corrosion metal material, to ensure greater sturdiness when pulling the lanyard to zip/unzip the wetsuit.



FRICTION FREE  
LOW NECKLINE  
2 MM NEOPRENE

OUTSIDE / INSIDE  
NYLON COVERED  
3MM NEOPRENE

COMPLETE FREEDOM OF  
MOVEMENT



### TECHNICAL FEATURES

- The ultimate swimming wetsuit
- Completely designed with a sophisticated 3d modelling software
- Graphics inspired by underwater volcanic eruption
- Maximum visibility for the swimmer when in open water
- Back zip
- Different thicknesses (2-3 mm)



PRODUCT	THK	SIZE	CODE	DLR €	10%	S.O. 20%	RRP €
KARUA SWIMSUIT BLACK/LIME	3/2 mm	MAN XS/1	DG002901	124.99	112.49	99.99	199.99
KARUA SWIMSUIT BLACK/LIME	3/2 mm	MAN S/2	DG002902	124.99	112.49	99.99	199.99
KARUA SWIMSUIT BLACK/LIME	3/2 mm	MAN M/3	DG002903	124.99	112.49	99.99	199.99
KARUA SWIMSUIT BLACK/LIME	3/2 mm	MAN L/4	DG002904	124.99	112.49	99.99	199.99
KARUA SWIMSUIT BLACK/LIME	3/2 mm	MAN XL/5	DG002905	124.99	112.49	99.99	199.99
KARUA SWIMSUIT BLACK/LIME	3/2 mm	MAN 2XL/6	DG002906	124.99	112.49	99.99	199.99
KARUA SWIMSUIT BLACK/TURQUOISE	3/2 mm	LADY XS/1	DG003001	124.99	112.49	99.99	199.99
KARUA SWIMSUIT BLACK/TURQUOISE	3/2 mm	LADY S/2	DG003002	124.99	112.49	99.99	199.99
KARUA SWIMSUIT BLACK/TURQUOISE	3/2 mm	LADY M/3	DG003003	124.99	112.49	99.99	199.99
KARUA SWIMSUIT BLACK/TURQUOISE	3/2 mm	LADY L/4	DG003004	124.99	112.49	99.99	199.99



# TRITON

THICKNESS  
1.5 MM

BACK  
ZIP

UV  
PROTECTION

QUICK  
DRYING

SUPER  
STRETCH

18 - 26 ° C  
65 - 79 ° F

## MONOPIECE WETSUIT 1.5 mm

Wetsuit made of 1.5 mm neoprene ULTRASKIN for swimming in open water. For safety, it has a special insert in the forearms, fluorescent green for men or fluorescent

orange for women, that allows immediate sighting during the activity. It also features a key pocket and a label for a name.



### TECHNICAL FEATURES

- Designed for optimizes comfort and prevents scraping
- 1.5 mm high density neoprene
- Smooth exterior finish and Glide Skin water-proof treatment
- Exceptional hydrodynamics

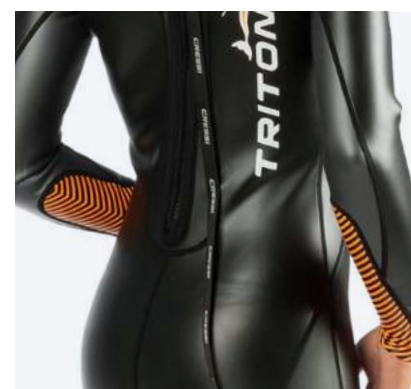

HIGH VISIBILITY PADS



ANTI-SEEPAGE COLLAR



PRODUCT	THK	SIZE	CODE	DLR €	10%	SEASONAL ORDER 20%	RRP €
TRITON SWIMSUIT BLACK/GREEN	1.5 mm	MAN XS/1	DG002201	187,49	168,74	149,99	289,99
TRITON SWIMSUIT BLACK/GREEN	1.5 mm	MAN S/2	DG002202	187,49	168,74	149,99	289,99
TRITON SWIMSUIT BLACK/GREEN	1.5 mm	MAN M/3	DG002203	187,49	168,74	149,99	289,99
TRITON SWIMSUIT BLACK/GREEN	1.5 mm	MAN L/4	DG002204	187,49	168,74	149,99	289,99
TRITON SWIMSUIT BLACK/GREEN	1.5 mm	MAN XL/5	DG002205	187,49	168,74	149,99	289,99
TRITON SWIMSUIT BLACK/GREEN	1.5 mm	MAN 2XL/6	DG002206	187,49	168,74	149,99	289,99
TRITON SWIMSUIT BLACK/ORANGE	1.5 mm	LADY XS/1	DG002301	187,49	168,74	149,99	289,99
TRITON SWIMSUIT BLACK/ORANGE	1.5 mm	LADY S/2	DG002302	187,49	168,74	149,99	289,99
TRITON SWIMSUIT BLACK/ORANGE	1.5 mm	LADY M/3	DG002303	187,49	168,74	149,99	289,99
TRITON SWIMSUIT BLACK/ORANGE	1.5 mm	LADY L/4	DG002304	187,49	168,74	149,99	289,99

# SWIM HOOD

## 2 mm

THICKNESS  
2 MM

HIGH VISIBILITY  
STRIPES

PRODUCT	THK	SIZE	CODE	DLR €	10%	SEASONAL ORDER 20%	RRP €
SWIM HOOD	2 mm	S/M	DG002397	28,74	25,87	22,99	45,99
SWIM HOOD	2 mm	L/XL	DG002398	28,74	25,87	22,99	45,99



/ SWIMMING WETSUITS

# TERMICO

## NEOPRENE SWIMSUIT, LONG SLEEVES 2 mm

Women's all-in-one suit that is shaped like a one-piece swimsuit. The first suit that provides thermal comfort. In soft 2 mm neoprene.

Designed specifically for swimming, snorkeling and water sports in general, it allows great freedom of movement thanks to the special style and elasticity of the material. It is made from double lined 2 mm neoprene and comes with a front zip that makes it easy to put on and take off.

2-MM ULTRASPAN LINED NEOPRENE

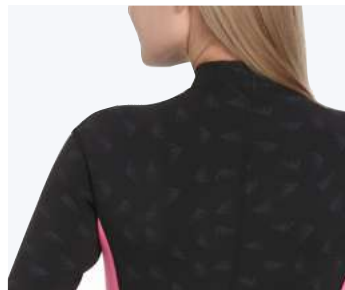
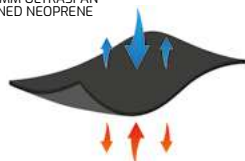

THICKNESS 2 MM | FRONT ZIP | SUPER STRETCH | 18 - 26 ° C 65 - 79° F

PRODUCT	THK	SIZE	CODE	DLR €	10%	SEASONAL ORDER 20%	RRP €
TERMICO LONG/SL LADY SWIMSUIT PINK/WHITE	2 mm	XS/1	XDG0001011	74,99	67,49	59,99	119,99
TERMICO LONG/SL LADY SWIMSUIT PINK/WHITE	2 mm	S/2	XDG0001012	74,99	67,49	59,99	119,99
TERMICO LONG/SL LADY SWIMSUIT PINK/WHITE	2 mm	M/3	XDG0001013	74,99	67,49	59,99	119,99
TERMICO LONG/SL LADY SWIMSUIT PINK/WHITE	2 mm	L/4	XDG0001014	74,99	67,49	59,99	119,99
TERMICO LONG/SL LADY SWIMSUIT PINK/WHITE	2 mm	XL/5	XDG0001015	74,99	67,49	59,99	119,99
TERMICO LONG/SL LADY SWIMSUIT PINK/WHITE	2 mm	2XL/6	XDG0001016	74,99	67,49	59,99	119,99

# TERMICO

## NEOPRENE SWIMSUIT 2 mm

Women's all-in-one suit that is shaped like a one-piece swimsuit. The first suit that provides thermal comfort. In soft 2 mm neoprene.

Designed specifically for swimming, snorkeling and water sports in general, it allows great freedom of movement thanks to the special style and elasticity of the material. It is made from double lined 2 mm neoprene and comes with a front zip that makes it easy to put on and take off.

2-MM ULTRASPAN LINED NEOPRENE

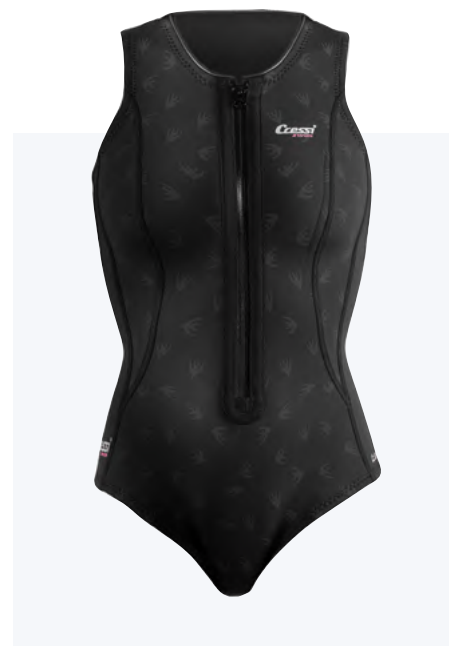
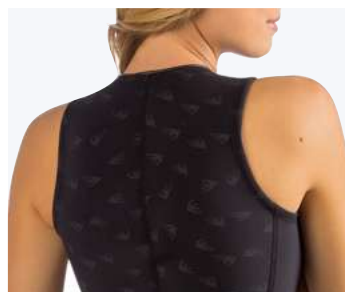
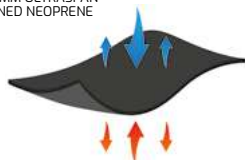

THICKNESS 2 MM | FRONT ZIP | SUPER STRETCH | 18 - 26 ° C 65 - 79° F

PRODUCT	THK	SIZE	CODE	DLR €	10%	SEASONAL ORDER 20%	RRP €
TERMICO LADY SWIMSUIT BLACK	2 mm	XS/1	DG000501	64,99	58,49	51,99	105,99
TERMICO LADY SWIMSUIT BLACK	2 mm	S/2	DG000502	64,99	58,49	51,99	105,99
TERMICO LADY SWIMSUIT BLACK	2 mm	M/3	DG000503	64,99	58,49	51,99	105,99
TERMICO LADY SWIMSUIT BLACK	2 mm	L/4	DG000504	64,99	58,49	51,99	105,99
TERMICO LADY SWIMSUIT BLACK	2 mm	XL/5	DG000505	64,99	58,49	51,99	105,99



# DEA

## NEOPRENE SWIMSUIT 1 mm

THICKNESS 1 MM | ZIPLESS DESIGN | SUPER STRETCH | 18 - 26 ° C 65 - 79° F 

### TECHNICAL FEATURES

- Anatomically designed to give women maximum comfort and wearability
- Elegant, without zipper
- 100% Ultrastretch
- Upper part in smooth neoprene inside
- Suitable for open water, swimming pool and aquagym

2-MM ULTRASPAN LINED NEOPRENE

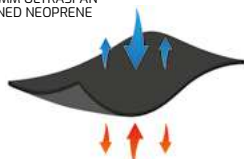

PRODUCT	THK	SIZE	CODE	DLR €	10%	SEASONAL ORDER 20%	RRP €
DEA NEOPRENE SWIMSUIT BLACK/BLACK	1 mm	XS/1	DG005401	56,24	50,62	44,99	87,99
DEA NEOPRENE SWIMSUIT BLACK/BLACK	1 mm	S/2	DG005402	56,24	50,62	44,99	87,99
DEA NEOPRENE SWIMSUIT BLACK/BLACK	1 mm	M/3	DG005403	56,24	50,62	44,99	87,99
DEA NEOPRENE SWIMSUIT BLACK/BLACK	1 mm	L/4	DG005404	56,24	50,62	44,99	87,99
DEA NEOPRENE SWIMSUIT BLACK/BLACK	1 mm	XL/5	DG005405	56,24	50,62	44,99	87,99

# TERMICO MAN

## SHORTY NEOPRENE SWIMSUIT 2 mm

THICKNESS 2 MM | FRONT ZIP | SUPER STRETCH | 18 - 26 ° C 65 - 79° F 

Thermal comfort shorty for swimming, in highly elastic 2-mm Ultraspan lined neoprene. Glide-skin anti-friction treatment in the underarm area. Glide-skin anti-seepage seals at the neck and legs.

2-MM ULTRASPAN LINED NEOPRENE

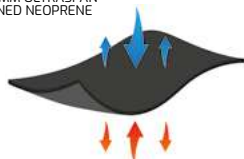

PRODUCT	THK	SIZE	CODE	DLR €	10%	SEASONAL ORDER 20%	RRP €
TERMICO MAN SHORTY SWIMSUIT	2 mm	S/2	DG000902	103,74	93,37	82,99	164,99
TERMICO MAN SHORTY SWIMSUIT	2 mm	M/3	DG000903	103,74	93,37	82,99	164,99
TERMICO MAN SHORTY SWIMSUIT	2 mm	L/4	DG000904	103,74	93,37	82,99	164,99
TERMICO MAN SHORTY SWIMSUIT	2 mm	XL/5	DG000905	103,74	93,37	82,99	164,99
TERMICO MAN SHORTY SWIMSUIT	2 mm	2XL/6	DG000906	103,74	93,37	82,99	164,99

# WETSUITS SIZE CHARTS

- Dry suits
- Semi-dry suits
- Monopieces
- Two-pieces (Jacket + Pants)
- Shorties

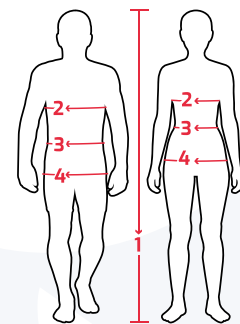

		WEIGHT		(1) HEIGHT		(2) CHEST		(3) WAIST		(4) HIP		FOOT			
		Size	kg	lbs	cm	in	cm	in	cm	in	cm	in	EU	UK	US
DRY SUIT MEN	S-II-48	60-68	132-150	164-170	65-67	78-83	31-33	65-71	25-28	78-83	31-33	40-42	7-8	7.5-8.5	
	M-III-50	70-78	154-172	169-175	67-69	86-91	34-36	71-77	28-30	84-89	33-35	41-43	7.5-8.5	8-9	
	L-IV-52	80-88	176-194	174-180	69-71	94-99	37-39	77-83	30-33	90-95	35-37	42-44	8-10	8.5-10.5	
	XL-V-54	90-98	198-216	179-185	71-73	102-107	40-42	83-89	33-35	96-101	38-40	43-45	8.5-11	9-11.5	
	XXL-VI-56	100-108	220-238	184-190	73-75	110-115	43-45	89-95	35-37	102-107	40-42	44-46	10-11.5	10.5-12	
DRY SUIT WOMEN	XS-I-42	47-52	104-115	157-162	62-64	77-82	30-32	56-61	22-24	83-87	32-34	37-39	4.5-6.5	5-7	
	S-II-44	53-58	117-128	162-167	64-66	82-87	32-34	60-65	24-26	87-91	34-36	38-40	5.5-7	6-7.5	
	M-III-46	59-64	130-141	167-172	66-68	87-92	34-36	64-69	25-27	91-95	36-37	39-41	6.5-7.5	7-8	
	L-IV-48	64-70	141-154	172-177	68-70	92-97	36-38	68-73	27-29	95-99	37-39	40-42	7-8	7.5-8.5	
	XL-V-50	70-80	154-176	177-182	70-72	97-102	38-40	72-77	28-30	99-103	39-41	41-43	7.5-8.5	8-9	
SEMI DRY, MONOPIECE, TWO-PIECE, WETSUIT MEN	S-II-48	60-68	132-150	164-173	65-68	78-83	31-33	65-71	25-28	78-83	31-33	-	-	-	
	M-III-50	70-78	154-172	169-178	67-70	86-91	34-36	71-77	28-30	84-89	33-35	-	-	-	
	L-IV-52	80-88	176-194	174-183	69-72	94-99	37-39	77-83	30-33	90-95	35-37	-	-	-	
	XL-V-54	90-98	198-216	179-188	71-74	102-107	40-42	83-89	33-35	96-101	38-40	-	-	-	
	XXL-VI-56	100-108	220-238	184-193	72-76	110-115	43-45	89-95	35-37	102-107	40-42	-	-	-	
XXXL-VII-58	105-115	231-254	191-198	75-78	118-123	46-48	95-101	37-40	108-113	43-45	-	-	-		
SEMI DRY, MONOPIECE, TWO-PIECE, WETSUIT WOMEN	XS-I-40	47-52	104-115	160-165	63-65	77-82	30-32	56-61	22-24	83-87	32-34	-	-	-	
	S-II-42	53-58	117-128	165-170	65-67	82-87	32-34	60-65	24-26	87-91	34-36	-	-	-	
	M-III-44	59-64	130-141	170-175	67-69	87-92	34-36	64-69	25-27	91-95	36-37	-	-	-	
	L-IV-46	64-70	141-154	175-180	69-71	92-97	36-38	68-73	27-29	95-99	37-39	-	-	-	
	XL-V-48	70-80	154-176	180-185	71-73	97-102	38-40	72-77	28-30	99-103	39-41	-	-	-	
SHORTY WETSUIT MEN	XS-I-46	50-58	110-128	156-165	61-65	70-75	28-30	59-65	23-26	72-77	28-30	-	-	-	
	S-II-48	60-68	132-150	164-173	65-68	78-83	31-33	65-71	26-28	78-83	31-33	-	-	-	
	M-III-50	70-78	154-172	169-178	67-70	86-91	34-36	71-77	28-30	84-89	33-35	-	-	-	
	L-IV-52	80-88	176-194	174-183	69-72	94-99	37-39	77-83	30-33	90-95	35-37	-	-	-	
	XL-V-54	90-98	198-216	179-188	71-74	102-107	40-42	83-89	33-35	96-101	38-40	-	-	-	
XXL-VI-56	100-108	220-238	184-193	72-76	110-115	43-45	89-95	35-37	102-107	40-42	-	-	-		
SHORTY WETSUIT WOMEN	XS-I-40	47-52	104-115	160-165	63-65	77-82	30-32	56-61	22-24	83-87	32-34	-	-	-	
	S-II-42	53-58	117-128	165-170	65-67	82-87	32-34	60-65	24-26	87-91	34-36	-	-	-	
	M-III-44-46	59-64	130-141	170-175	67-69	87-92	34-36	64-69	25-27	91-95	36-37	-	-	-	
	L-IV-48-50	64-70	141-154	175-180	69-71	92-97	36-38	68-73	27-29	95-99	37-39	-	-	-	

Photo by: Kayleigh Burns & Cam Grant





Photo by: Krystal Klear



CRESSI  
SINCE 1941

2mm

# NEOPRENE ACCESSORIES



# SHELL JACKET

## OVERSUIT 5+3.5 mm

Multi thickness neoprene jacket, designed to be worn over the wetsuit.

Back and chest: 5 mm  
Underarms and inseam: 3.5 mm

OVERSUIT WEAR | MULTI THICKNESS 5+3.5 MM



PRODUCT	THK	SIZE	CODE	DLR €	10%	SEASONAL ORDER 20%	RRP €
SHELL JACKET	5 mm	MAN S/2	LS560002	106,24	95,62	84,99	159,99
SHELL JACKET	5 mm	MAN M/3	LS560003	106,24	95,62	84,99	159,99
SHELL JACKET	5 mm	MAN L/4	LS560004	106,24	95,62	84,99	159,99
SHELL JACKET	5 mm	MAN XL/5	LS560005	106,24	95,62	84,99	159,99
SHELL JACKET	5 mm	MAN 2XL/6	LS560006	106,24	95,62	84,99	159,99
SHELL JACKET	5 mm	MAN 3XL/7	LS560007	106,24	95,62	84,99	159,99
SHELL JACKET	5 mm	LADY XS/1	LS561001	106,24	95,62	84,99	159,99
SHELL JACKET	5 mm	LADY S/2	LS561002	106,24	95,62	84,99	159,99
SHELL JACKET	5 mm	LADY M/3	LS561003	106,24	95,62	84,99	159,99
SHELL JACKET	5 mm	LADY L/4	LS561004	106,24	95,62	84,99	159,99
SHELL JACKET	5 mm	LADY XL/5	LS561005	106,24	95,62	84,99	159,99



# HOOD VEST

## BASE LAYER 2.5+5 mm

Multi thickness neoprene vest, designed to be worn under the wetsuit.

Vest: 2.5 mm  
Hood: 5 mm

UNDERSUIT WEAR | MULTI THICKNESS 2.5 +5 MM



PRODUCT	THK	SIZE	CODE	DLR €	10%	SEASONAL ORDER 20%	RRP €
BASE LAYER HOOD VEST	2.5 mm	MAN S/2	LW476212	84,99	76,49	67,99	134,99
BASE LAYER HOOD VEST	2.5 mm	MAN M/3	LW476213	84,99	76,49	67,99	134,99
BASE LAYER HOOD VEST	2.5 mm	MAN L/4	LW476214	84,99	76,49	67,99	134,99
BASE LAYER HOOD VEST	2.5 mm	MAN XL/5	LW476215	84,99	76,49	67,99	134,99
BASE LAYER HOOD VEST	2.5 mm	MAN 2XL/6	LW476216	84,99	76,49	67,99	134,99
BASE LAYER HOOD VEST	2.5 mm	MAN 3XL/7	LW476217	84,99	76,49	67,99	134,99
BASE LAYER HOOD VEST	2.5 mm	LADY XS/1	LW476231	84,99	76,49	67,99	134,99
BASE LAYER HOOD VEST	2.5 mm	LADY S/2	LW476232	84,99	76,49	67,99	134,99
BASE LAYER HOOD VEST	2.5 mm	LADY M/3	LW476233	84,99	76,49	67,99	134,99
BASE LAYER HOOD VEST	2.5 mm	LADY L/4	LW476234	84,99	76,49	67,99	134,99
BASE LAYER HOOD VEST	2.5 mm	LADY XL/5	LW476235	84,99	76,49	67,99	134,99

# SHORTS VEST

UNDERSUIT WEAR | THICKNESS 2.5 MM

## BASE LAYER 2.5 mm

2.5 mm neoprene shorty undersuit, designed to be worn under the wetsuit.



PRODUCT	THK	SIZE	CODE	DLR €	10%	SEASONAL ORDER 20%	RRP €
BASE LAYER SHORTS VEST	2.5 mm	MAN S/2	LW476512	62.49	56.24	49.99	99.99
BASE LAYER SHORTS VEST	2.5 mm	MAN M/3	LW476513	62.49	56.24	49.99	99.99
BASE LAYER SHORTS VEST	2.5 mm	MAN L/4	LW476514	62.49	56.24	49.99	99.99
BASE LAYER SHORTS VEST	2.5 mm	MAN XL/5	LW476515	62.49	56.24	49.99	99.99
BASE LAYER SHORTS VEST	2.5 mm	MAN 2XL/6	LW476516	62.49	56.24	49.99	99.99
BASE LAYER SHORTS VEST	2.5 mm	MAN 3XL/7	LW476517	62.49	56.24	49.99	99.99
BASE LAYER SHORTS VEST	2.5 mm	LADY XS/1	LW476521	62.49	56.24	49.99	99.99
BASE LAYER SHORTS VEST	2.5 mm	LADY S/2	LW476522	62.49	56.24	49.99	99.99
BASE LAYER SHORTS VEST	2.5 mm	LADY M/3	LW476523	62.49	56.24	49.99	99.99
BASE LAYER SHORTS VEST	2.5 mm	LADY L/4	LW476524	62.49	56.24	49.99	99.99
BASE LAYER SHORTS VEST	2.5 mm	LADY XL/5	LW476525	62.49	56.24	49.99	99.99

# CORE VEST

UNDERSUIT WEAR | THICKNESS 2.5 MM

## BASE LAYER 2.5 mm

2.5 mm neoprene core vest, designed to be worn under the wetsuit.



PRODUCT	THK	SIZE	CODE	DLR €	10%	SEASONAL ORDER 20%	RRP €
BASE LAYER CORE VEST	2.5 mm	MAN S/2	LW476102	56.24	50.62	44.99	87.99
BASE LAYER CORE VEST	2.5 mm	MAN M/3	LW476103	56.24	50.62	44.99	87.99
BASE LAYER CORE VEST	2.5 mm	MAN L/4	LW476104	56.24	50.62	44.99	87.99
BASE LAYER CORE VEST	2.5 mm	MAN XL/5	LW476105	56.24	50.62	44.99	87.99
BASE LAYER CORE VEST	2.5 mm	MAN 2XL/6	LW476106	56.24	50.62	44.99	87.99
BASE LAYER CORE VEST	2.5 mm	MAN 3XL/7	LW476107	56.24	50.62	44.99	87.99
BASE LAYER CORE VEST	2.5 mm	LADY XS/1	LW476111	56.24	50.62	44.99	87.99
BASE LAYER CORE VEST	2.5 mm	LADY S/2	LW476112	56.24	50.62	44.99	87.99
BASE LAYER CORE VEST	2.5 mm	LADY M/3	LW476113	56.24	50.62	44.99	87.99
BASE LAYER CORE VEST	2.5 mm	LADY L/4	LW476114	56.24	50.62	44.99	87.99
BASE LAYER CORE VEST	2.5 mm	LADY XL/5	LW476115	56.24	50.62	44.99	87.99



# ORUST

## HOOD 5 mm

Hood with an oversized crew neck that allows a better water tightness for those who want to use it by inserting it under the neck of the wetsuit. It is particularly suitable for one-piece wetsuits with a front zip. Anatomical cut. 100% high-stretch material. 3 mm smooth skin with watertight seals around the face and the neck.

THICKNESS 5 MM | 100% HIGH STRETCH MATERIAL



PRODUCT	THK	SIZE	CODE	DLR €	10%	SEASONAL ORDER 20%	RRP €
ORUST HOOD	5 mm	UNISEX S/2	LS601502	37,49	33,74	29,99	59,99
ORUST HOOD	5 mm	UNISEX M/3	LS601503	37,49	33,74	29,99	59,99
ORUST HOOD	5 mm	UNISEX L/4	LS601504	37,49	33,74	29,99	59,99
ORUST HOOD	5 mm	UNISEX XL/5	LS601505	37,49	33,74	29,99	59,99
ORUST HOOD	5 mm	UNISEX 2XL/6	LS601506	37,49	33,74	29,99	59,99



# DRAGET PLUS

## WITH HOOD HOLDER 5 mm

Neoprene hood with integrated hook

THICKNESS 5 MM | INTEGRATED HOOD HOLDER



PRODUCT	THK	SIZE	CODE	DLR €	10%	SEASONAL ORDER 20%	RRP €
HOOD DRAGET PLUS	5 mm	MAN S/2	LS550601	31,24	28,12	24,99	49,99
HOOD DRAGET PLUS	5 mm	MAN M/3-4	LS550602	31,24	28,12	24,99	49,99
HOOD DRAGET PLUS	5 mm	MAN L/5-6-7	LS550603	31,24	28,12	24,99	49,99
HOOD DRAGET PLUS	5 mm	LADY XS/0	LS551200	31,24	28,12	24,99	49,99
HOOD DRAGET PLUS	5 mm	LADY S/2-2	LS551201	31,24	28,12	24,99	49,99
HOOD DRAGET PLUS	5 mm	LADY M/4-4	LS551202	31,24	28,12	24,99	49,99



# DRAGET

## HOOD 5 mm, 3 mm

Neoprene hood available in two different thickness: 5 mm or 3 mm.

AVAILABLE IN TWO THICKNESS: 5 OR 3 MM



PRODUCT	THK	SIZE	CODE	DLR €	10%	SEASONAL ORDER 20%	RRP €
HOOD DRAGET	5 mm	MAN S/2	LR107401	19,99	17,99	15,99	31,99
HOOD DRAGET	5 mm	MAN M/3-4	LR107402	19,99	17,99	15,99	31,99
HOOD DRAGET	5 mm	MAN L/5-6-7	LR107403	19,99	17,99	15,99	31,99
HOOD DRAGET	5 mm	LADY XS/0	LR107500	19,99	17,99	15,99	31,99
HOOD DRAGET	5 mm	LADY S/2-2	LR107501	19,99	17,99	15,99	31,99
HOOD DRAGET	5 mm	LADY M/4-4	LR107502	19,99	17,99	15,99	31,99
HOOD DRAGET	3 mm	UNISEX XS	LR108001	19,99	17,99	15,99	31,99
HOOD DRAGET	3 mm	UNISEX S	LR108002	19,99	17,99	15,99	31,99
HOOD DRAGET	3 mm	UNISEX M	LR108003	19,99	17,99	15,99	31,99
HOOD DRAGET	3 mm	UNISEX L	LR108004	19,99	17,99	15,99	31,99

# CEMENT

## NEOPRENE GLUE



**DESCRIPTION:**  
Neoprene repairing glue, 30 gr

CODE	DLR €	10%	S.O. 20%	RRP €
TA650000	4,99	4,49	3,99	8,99

# PVC GLUE

## POLYURETHANE ADHESIVE



**DESCRIPTION:**  
Polyurethane adhesive for pvc patches, ideal for puncture repairing, 30 ml.

CODE	DLR €	10%	S.O. 20%	RRP €
NZ000400	9,29	8,36	7,43	12,99

# HANGER

## MULTI PURPOSE HANGER



**DESCRIPTION:**  
Wetsuits and equipment hanger

CODE	DLR €	10%	S.O. 20%	RRP €
TA700001	12,49	11,24	9,99	19,99

# KORSOR

THICKNESS 5 MM RIGID HARD SOLE

## HARD SOLE NEOPRENE BOOTS 5 mm

VELCRO ANKLE STRIP



SIZE	EU	CODE	DLR €	10%	SEASONAL ORDER 20%	RRP €
S	38-39	LX433401	68,74	61,87	54,99	109,99
M	40-41	LX433402	68,74	61,87	54,99	109,99
L	42-43	LX433403	68,74	61,87	54,99	109,99
XL	44-45	LX433404	68,74	61,87	54,99	109,99
2XL	46-47	LX433405	68,74	61,87	54,99	109,99

# ULTRASPAN

THICKNESS 5 MM

## NEOPRENE BOOTS 5 mm

Boots with non-slip soles are ideal for use with open heel fins. Reinforcements on the back of the foot and the heel provide protection against wear and tear.



SIZE	EU	CODE	DLR €	10%	SEASONAL ORDER 20%	RRP €
XS	36-37	LX432700	37,49	33,74	29,99	59,99
S	38-39	LX432701	37,49	33,74	29,99	59,99
M	40-41	LX432702	37,49	33,74	29,99	59,99
L	42-43	LX432703	37,49	33,74	29,99	59,99
XL	44-45	LX432704	37,49	33,74	29,99	59,99
2XL	46-47	LX432705	37,49	33,74	29,99	59,99

# ISLA

THICKNESSES AVAILABLE: 3.5-5-7 MM

## NEOPRENE BOOTS 3.5 mm, 5 mm, 7 mm



THK	SIZE	EU	CODE	DLR €	10%	SEASONAL ORDER 20%	RRP €
3.5 mm	XS	36-37	LX432000	34,99	31,49	27,99	55,99
3.5 mm	S	38-39	LX432001	34,99	31,49	27,99	55,99
3.5 mm	M	40-41	LX432002	34,99	31,49	27,99	55,99
3.5 mm	L	42-43	LX432003	34,99	31,49	27,99	55,99
3.5 mm	XL	44-45	LX432004	34,99	31,49	27,99	55,99
3.5 mm	2XL	46-47	LX432005	34,99	31,49	27,99	55,99
5 mm	XS	36-37	LX432500	37,49	33,74	29,99	59,99
5 mm	S	38-39	LX432501	37,49	33,74	29,99	59,99
5 mm	M	40-41	LX432502	37,49	33,74	29,99	59,99
5 mm	L	42-43	LX432503	37,49	33,74	29,99	59,99
5 mm	XL	44-45	LX432504	37,49	33,74	29,99	59,99
5 mm	2XL	46-47	LX432505	37,49	33,74	29,99	59,99
7 mm	XS	36-37	LX432600	39,99	35,99	31,99	64,99
7 mm	S	38-39	LX432601	39,99	35,99	31,99	64,99
7 mm	M	40-41	LX432602	39,99	35,99	31,99	64,99
7 mm	L	42-43	LX432603	39,99	35,99	31,99	64,99
7 mm	XL	44-45	LX432604	39,99	35,99	31,99	64,99
7 mm	2XL	46-47	LX432605	39,99	35,99	31,99	64,99

# LOW

THICKNESS 3 MM

## LOW BOOTS 3 mm

3 mm neoprene boots, with non-slip soles, highly elastic and comfortable.



SIZE	EU	CODE	DLR €	10%	SEASONAL ORDER 20%	RRP €
XS	36-37	XLX430900	26,24	23,62	20,99	41,99
S	38-39	XLX430901	26,24	23,62	20,99	41,99
M	40-41	XLX430902	26,24	23,62	20,99	41,99
L	42-43	XLX430903	26,24	23,62	20,99	41,99
XL	44-45	XLX430904	26,24	23,62	20,99	41,99
2XL	46-47	XLX430905	26,24	23,62	20,99	41,99





/ SOCKS

# SARAGO

## THERMAL SOCKS

### 3 mm, 5 mm

THICKNESSES AVAILABLE: 3-5 MM  
 SOFT HIGHLY ELASTIC NYLON-LINED NEOPRENE  
 ANTI-SLIP GRIP SOLE  
 SMOOTH SKIN NEOPRENE ANKLE  
 BLINDSTICH SEAM CONSTRUCTION

SMOOTH SKIN NEOPRENE

ANTI-SLIP GRIP SOLE



These socks for fins with strap or foot pocket are made of soft highly elastic nylon-lined neoprene. They prevent heat loss and keep feet warm. The smooth skin neoprene on the ankle allows maximum adherence between the sock and the leg of the wetsuit, reducing the passage of water. The sole is entirely non-slip. The construction of the blind stitch seam further improves comfort and aesthetics.

SIZE	EU	THK	CODE	DLR €	10%	SEASONAL ORDER 20%	RRP €
S	38-39	3 mm	XLX434301	21,24	19,12	16,99	34,99
M	40-41	3 mm	XLX434302	21,24	19,12	16,99	34,99
L	42-43	3 mm	XLX434303	21,24	19,12	16,99	34,99
XL	44-45	3 mm	XLX434304	21,24	19,12	16,99	34,99
2XL	46-47	3 mm	XLX434305	21,24	19,12	16,99	34,99
S	38-39	5 mm	XLX440502	23,74	21,37	18,99	37,99
M	40-41	5 mm	XLX440503	23,74	21,37	18,99	37,99
L	42-43	5 mm	XLX440504	23,74	21,37	18,99	37,99
XL	44-45	5 mm	XLX440505	23,74	21,37	18,99	37,99
2XL	46-47	5 mm	XLX440506	23,74	21,37	18,99	37,99

# FINS SOCKS

## TEXTILE SOCKS

ULTRA STRETCH TEXTILE MATERIALS



These fin-socks are designed for people who live in their fins and need that perfect snug fit of a full foot fin. But also for people who seldom use fins or have sensitive feet. These socks are the solution that will allow you wearing your fins for hours and more without chafing your feet.

SIZE	EU	CODE	DLR €	10%	SEASONAL ORDER 20%	RRP €
S/M	36-41	USW030000K	11,24	10,12	8,99	17,99
L/XL	42-46	USW031000K	11,24	10,12	8,99	17,99

# ORATA

## NEOPRENE SOCKS 2.5 mm

SMOOTH SKIN NEOPRENE | THICKNESS 2.5 MM

SMOOTH SKIN NEOPRENE

ANTI-SLIP GRIP SOLE



These are single-lined, thin, high stretch neoprene boots. The inner is lined in Metallite so they are easy to put on. The sole has an effective non-slip lining. They can be used with both closed foot fins to protect the skin from scratches and chafing, as well as with firm-soled boots, using open-heel fins.

SIZE	EU	CODE	DLR €	10%	SEASONAL ORDER 20%	RRP €
S	36-38	LX433001	20,63	18,57	16,50	32,99
M	39-40	LX433002	20,63	18,57	16,50	32,99
L	41-42	LX433003	20,63	18,57	16,50	32,99
XL	43-44	LX433004	20,63	18,57	16,50	32,99

# ULTRASTRETCH

## NEOPRENE SOCKS 1.5 mm

THICKNESS 1.5 MM  
NON-SLIP SOLE



GREY | BLACK

SMOOTH SKIN NEOPRENE ON THE INTERNAL UPPER PART

ANTI-SLIP GRIP SOLE



Created in extremely supple, 1.5 mm thick, double-lined Ultraspan neoprene, these boots have non-slip and anti-wear soles and an Aquastop sealin single-lined neoprene at the top.

SIZE	EU	GREY	BLACK	DLR €	10%	SEASONAL ORDER 20%	RRP €
S	36-39	DF200030	XDF200150	24,99	22,49	19,99	39,99
M	40-42	DF200031	XDF200151	24,99	22,49	19,99	39,99
L	43-45	DF200032	XDF200152	24,99	22,49	19,99	39,99
XL	46-48	-	XDF200153	24,99	22,49	19,99	39,99

# ULTRASPAN

THICKNESS  
3.5 MM

## 100% HIGH-STRETCH NEOPRENE GLOVES 3.5 mm

5 finger neoprene gloves Ultraspán in addition to the already 'full range of gloves Cressi want to combine the flexibility of these new materials come onto the market over the past years with the wear resistance of previous models.

Technical Features For this particular model have been studied as important as the depth of the fingers, perfect closing of the wrist, not through seams.



SIZE	CODE	DLR €	10%	SEASONAL ORDER 20%	RRP €
XS	LX476310	37,49	33,74	29,99	59,99
S	LX476311	37,49	33,74	29,99	59,99
M	LX476312	37,49	33,74	29,99	59,99
L	LX476313	37,49	33,74	29,99	59,99
XL	LX476314	37,49	33,74	29,99	59,99

# HIGH STRETCH

THICKNESSES AVAILABLE:  
2.5 mm, 3.5 mm, 5 mm

## NEOPRENE GLOVES 2.5 mm, 3.5 mm & 5 mm

5-finger gloves made from single-lined soft, high-stretch neoprene. The inside is covered in Metallite to make them easy to put on. The preformed shape favours the natural position of the hand, with semi-bent fingers. The entire surface is covered with a non-slip finish for a sure grip in all situations.

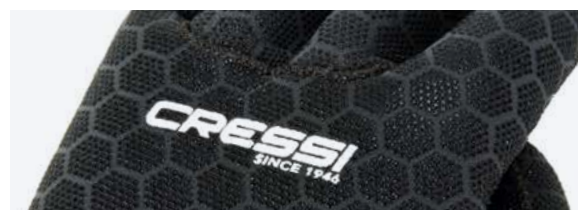

SIZE	2.5 mm	DLR €	10%	SEASONAL ORDER 20%	RRP €
S	LX475701	23,74	21,37	18,99	37,99
M	LX475702	23,74	21,37	18,99	37,99
L	LX475703	23,74	21,37	18,99	37,99
XL	LX475704	23,74	21,37	18,99	37,99

SIZE	3.5 mm	DLR €	10%	SEASONAL ORDER 20%	RRP €
S	LX475801	24,99	22,49	19,99	39,99
M	LX475802	24,99	22,49	19,99	39,99
L	LX475803	24,99	22,49	19,99	39,99
XL	LX475804	24,99	22,49	19,99	39,99

SIZE	5 mm	DLR €	10%	SEASONAL ORDER 20%	RRP €
S	LX475901	28,74	25,87	22,99	44,99
M	LX475902	28,74	25,87	22,99	44,99
L	LX475903	28,74	25,87	22,99	44,99
XL	LX475904	28,74	25,87	22,99	44,99

# DEFENDER

## HPPE GLOVES 2 mm

These gloves are made from HPPE, High Performance Poly Ethylene, a material that provides the hands with superior protection from cuts and abrasions. The finger reinforcement is made from rubber coating, works as a non-slip finish and facilitates a sure grip in all situations. Flexibility, lightweight and comfort are optimal.

ANTI-ABRASION MATERIAL HPPE  
 FIBERS DYNEEMA  
 RUBBER-COATED FINGERS  
 THICKNESS 2 MM



SIZE	CODE	DLR €	10%	SEASONAL ORDER 20%	RRP €
S	LX478601	18,74	16,87	14,99	29,99
M	LX478602	18,74	16,87	14,99	29,99
L	LX478603	18,74	16,87	14,99	29,99
XL	LX478604	18,74	16,87	14,99	29,99

# TROPICAL

## LIGHT GLOVES 2 mm

Five fingered gloves 2 mm thick neoprene, made from two different soft and light materials. The palm and finger area uses a light grey napa that becomes extraordinarily soft upon contact with the water. However, the upper part of the glove and the wrist area are made from very thin, supple neoprene. A large area that corresponds to the upper side of the wrist allows for instant adjustment, both before and during the dive. These are particularly suitable gloves when you need the very best touch sensitivity in the fingers. The palm also offers good resistance to abrasions.

THICKNESS 2 MM



SIZE	CODE	DLR €	10%	SEASONAL ORDER 20%	RRP €
S	LX475301	16,24	14,62	12,99	25,99
M	LX475302	16,24	14,62	12,99	25,99
L	LX475303	16,24	14,62	12,99	25,99
XL	LX475304	16,24	14,62	12,99	25,99
2XL	LX475305	16,24	14,62	12,99	25,99



# FINS



Photo by: Kayleigh Burns & Cam Grant

# THOR EBS SPECIALIZED Retailer-Product

FLOW CONVECTION EFFECT

SPECIAL ARCHED PROFILE

## ELASTIC BUNGEE SYSTEM SCUBA FINS

Brand new design for this extremely effective and yet very easy to use fin. The special arched profile of the fins combined with the two central ribs promote a significant flow convection effect, known as "spoon effect", which stabilises and boosts propulsion. Two lateral holes discharge the

negative forces typically associated with this area and at the same time make for enhanced stability. The blades are moulded from two different materials for improved reactivity. These fins are perfect for scuba diving, whether you are an experienced diver or a novice.



### TECHNICAL FEATURES



Cressi has developed this special strap to meet the needs of the most demanding divers, who need a comfortable fastening for their foot but one that is still practical and manageable. Its special amply sized slot makes it very easy to put on, even when wearing thick gloves or three-fingered gloves for winter water.

The wrapping section is highly flexible, making adjustments unnecessary, and as a result it's much easier to get all your equipment right in the first few meters of your descent and the fin stays in place against your foot despite the increase in hydrostatic pressure.



BLACK/SILVER

YELLOW

BLUE



PINK

RED

PRODUCT	SIZE	EU	CODE	PACK	DLR €	10%	SEASONAL ORDER 20%	RRP €
THOR EBS BLACK/GREY	XS/S	36/38	BE155036	3	63.74	57.37	50.99	109.99
THOR EBS BLACK/GREY	S/M	39/41	BE155039	3	63.74	57.37	50.99	109.99
THOR EBS BLACK/GREY	L	42/44	BE155042	3	63.74	57.37	50.99	109.99
THOR EBS BLACK/GREY	XL	45/49	BE155045	3	63.74	57.37	50.99	109.99
THOR EBS YELLOW	XS/S	36/38	BE151036	3	63.74	57.37	50.99	109.99
THOR EBS YELLOW	S/M	39/41	BE151039	3	63.74	57.37	50.99	109.99
THOR EBS YELLOW	L	42/44	BE151042	3	63.74	57.37	50.99	109.99
THOR EBS YELLOW	XL	45/49	BE151045	3	63.74	57.37	50.99	109.99
THOR EBS BLUE	XS/S	36/38	BE152036	3	63.74	57.37	50.99	109.99
THOR EBS BLUE	S/M	39/41	BE152039	3	63.74	57.37	50.99	109.99
THOR EBS BLUE	L	42/44	BE152042	3	63.74	57.37	50.99	109.99
THOR EBS BLUE	XL	45/49	BE152045	3	63.74	57.37	50.99	109.99
THOR EBS PINK	XS/S	36/38	BE154036	3	63.74	57.37	50.99	109.99
THOR EBS PINK	S/M	39/41	BE154039	3	63.74	57.37	50.99	109.99
THOR EBS RED	XS/S	36/38	BE155836	3	63.74	57.37	50.99	109.99
THOR EBS RED	S/M	39/41	BE155839	3	63.74	57.37	50.99	109.99
THOR EBS RED	L	42/44	BE155842	3	63.74	57.37	50.99	109.99
THOR EBS RED	XL	45/49	BE155845	3	63.74	57.37	50.99	109.99





# ARA EBS SPECIALIZED Retailer-Product

## ELASTIC BUNGEE SYSTEM SCUBA FINS

The main feature of this fin is its polypropylene blade that provides an excellent response. And weight is no longer a problem. These fins provide more thrust power to a diver's kicking, which results into an excellent effort/performance ratio. Special grooving for water channelling moulded on the surface provides outstanding stability and direction. The thermorubber foot pocket (with varying levels of hardness) is very comfortable

to wear and a proper fit is ensured by ergonomic design. The heel strap, an exclusive Cressi design, is a special round bungee cord band that perfectly adjusts to all foot sizes and shapes and provides a comfortable, practical and manageable fastening. It features a special ample slot for easy don and doff even when wearing thick gloves for cold-water diving.



### TECHNICAL FEATURES



Cressi has developed this special strap to meet the needs of the most demanding divers, who need a comfortable fastening for their foot but one that is still practical and manageable. Its special ample sized slot makes it very easy to put on, even when wearing thick gloves or three-fingered gloves for winter water.

The wrapping section is highly flexible, making adjustments unnecessary, and as a result it's much easier to get all your equipment right in the first few meters of your descent and the fin stays in place against your foot despite the increase in hydrostatic pressure.



PRODUCT	SIZE	EU	CODE	PACK	DLR €	10%	SEASONAL ORDER 20%	RRP €
ARA EBS FINS BLACK	S/M	39/41	BE135540	3	68.74	61.87	54.99	119.99
ARA EBS FINS BLACK	M/L	41/43	BE135542	3	68.74	61.87	54.99	119.99
ARA EBS FINS BLACK	L/XL	44/47	BE135544	3	68.74	61.87	54.99	119.99





# REACTION EBS

## ELASTIC BUNGEE SYSTEM SCUBA FINS

Cressi's most technically advanced fin, the Reaction uses a completely new polypropylene blade material that is more reactive, flexible and trim than previous designs. It kicks easily yet powerfully and is suitable for divers of every experience level. The longer blade efficiently transfers energy from the computer-designed foot pocket, and like other

Cressi fins, the blade extends from the top of the foot pocket to maximize its effective surface area for more thrust. Other innovations include new locking strap buckles and anti-slip material for better traction out of the water.



### TECHNICAL FEATURES



Cressi has developed this special strap to meet the needs of the most demanding divers, who need a comfortable fastening for their foot but one that is still practical and manageable.

Its special amply sized slot makes it very easy to put on, even when wearing thick gloves or three-fingered gloves for winter water.

The wrapping section is highly flexible, making adjustments unnecessary, and as a result it's much easier to get all your equipment right in the first few meters of your descent and the fin stays in place against your foot despite the increase in hydrostatic pressure.



BLUE/AZURE



BLACK/SILVER



WHITE/PINK



YELLOW/SILVER

PRODUCT	SIZE	EU	CODE	PACK	DLR €	10%	SEASONAL ORDER 20%	RRP €
REACTION EBS BLUE/AZURE	XS/S	36/39	BE092038	3	57,49	51,74	45,99	99,99
REACTION EBS BLUE/AZURE	S/M	39/42	BE092040	3	57,49	51,74	45,99	99,99
REACTION EBS BLUE/AZURE	M/L	42/45	BE092042	3	57,49	51,74	45,99	99,99
REACTION EBS BLUE/AZURE	L/XL	45/47	BE092044	3	57,49	51,74	45,99	99,99
REACTION EBS FINS BLACK/SILVER	XS/S	36/39	BE095538	3	57,49	51,74	45,99	99,99
REACTION EBS FINS BLACK/SILVER	S/M	39/42	BE095540	3	57,49	51,74	45,99	99,99
REACTION EBS FINS BLACK/SILVER	M/L	42/45	BE095542	3	57,49	51,74	45,99	99,99
REACTION EBS FINS BLACK/SILVER	L/XL	45/47	BE095544	3	57,49	51,74	45,99	99,99
REACTION EBS WHITE/PINK	XS/S	36/39	BE096438	3	57,49	51,74	45,99	99,99
REACTION EBS WHITE/PINK	S/M	39/42	BE096440	3	57,49	51,74	45,99	99,99
REACTION EBS YELLOW/SILVER	XS/S	36/39	BE091038	3	57,49	51,74	45,99	99,99
REACTION EBS YELLOW/SILVER	S/M	39/42	BE091040	3	57,49	51,74	45,99	99,99
REACTION EBS YELLOW/SILVER	M/L	42/45	BE091042	3	57,49	51,74	45,99	99,99
REACTION EBS YELLOW/SILVER	L/XL	45/47	BE091044	3	57,49	51,74	45,99	99,99

# FROG PLUS

## SCUBA FINS

The Frog Plus utilizes Cressi's patented three material injection molding process. The three materials consist of a nice comfortable rubber on the foot pocket that extends up the side rails of the blade. The second material is the revolutionary new dual density techno polymer which forms the blade, and in conjunction with the third silicone based material creates a channeling effect.

Cressi's latest addition to its extensive line of world renowned fins is the Frog Plus open heel scuba diving fin. The Frog Plus features many of the great characteristics of a traditional paddle fin along with introducing a revolutionary new blade material that is both extremely durable and nearly indestructible.



DOUBLE DENSITY TECHNOLOGY | SUPERIOR PERFORMANCE

### TECHNICAL FEATURES

- Made of a combination of 3 materials: Main body in polypropylene, flexible elastomer used in the liner and in areas that require flexibility and elasticity, compact elastomer for side stringers, sole and foot support band.
- Below blade foot pocket.
- Blade profile with decreasing thickness
- Reinforced liner in the upper area
- 360° rotating buckles
- Oversized heel strap
- EBS buckle system



BLACK/SILVER



BLACK/YELLOW



BLUE/SILVER



BLACK/PINK



BLACK/WHITE

PRODUCT	SIZE	EU	CODE	PACK	DLR €	10%	SEASONAL ORDER 20%	RRP €
FROG PLUS BLACK/SILVER	X5/S	36/39	BF205538	3	46.24	41.62	36.99	79.99
FROG PLUS BLACK/SILVER	S/M	39/42	BF205540	3	46.24	41.62	36.99	79.99
FROG PLUS BLACK/SILVER	M/L	42/45	BF205542	3	46.24	41.62	36.99	79.99
FROG PLUS BLACK/SILVER	L/XL	45/47	BF205544	3	46.24	41.62	36.99	79.99
FROG PLUS BLACK/YELLOW	X5/S	36/39	BF205138	3	46.24	41.62	36.99	79.99
FROG PLUS BLACK/YELLOW	S/M	39/42	BF205140	3	46.24	41.62	36.99	79.99
FROG PLUS BLACK/YELLOW	M/L	42/45	BF205142	3	46.24	41.62	36.99	79.99
FROG PLUS BLACK/YELLOW	L/XL	45/47	BF205144	3	46.24	41.62	36.99	79.99
FROG PLUS BLUE/SILVER	X5/S	36/39	BF202038	3	46.24	41.62	36.99	79.99
FROG PLUS BLUE/SILVER	S/M	39/42	BF202040	3	46.24	41.62	36.99	79.99
FROG PLUS BLUE/SILVER	M/L	42/45	BF202042	3	46.24	41.62	36.99	79.99
FROG PLUS BLUE/SILVER	L/XL	45/47	BF202044	3	46.24	41.62	36.99	79.99
FROG PLUS BLACK/PINK	X5/S	36/39	BF205438	3	46.24	41.62	36.99	79.99
FROG PLUS BLACK/PINK	S/M	39/42	BF205440	3	46.24	41.62	36.99	79.99
FROG PLUS BLACK/WHITE	X5/S	36/39	BF203038	3	46.24	41.62	36.99	79.99
FROG PLUS BLACK/WHITE	S/M	39/42	BF203040	3	46.24	41.62	36.99	79.99
FROG PLUS BLACK/WHITE	M/L	42/45	BF203042	3	46.24	41.62	36.99	79.99
FROG PLUS BLACK/WHITE	L/XL	45/47	BF203044	3	46.24	41.62	36.99	79.99



OPTIONAL EBS STRAP

# PRO LIGHT

## SCUBA FINS

A highly advanced design for this fin that is moulded from two materials with very different characteristics: a strong polypropylene for the blade and soft elastomers (thermo rubber) for the foot and protective inserts. The result is an extremely light and well-balanced fin, of average size, with surprising reaction time and a formidable thrust. The side stringers that

extend all along the blade and two flaps situated along the end of the blade itself make the fin very directional. The blade originates from the upper part of the foot pocket, with a 20% increase in useful surface area compared to a traditional fin of the same length. The foot pocket is computer designed and guarantees ideal transmission of the leg-fin thrust.

The lightness and perfect balance of the materials, together with the extremely modern design, make Rondine Pro Light a generous fin that provides exuberant performance without too much physical effort. These fins are perfect both for beginners and for professionals and are very common amongst instructors and technical divers.



PRODUCT	SIZE	EU	CODE	PACK	DLR €	10%	SEASONAL ORDER 20%	RRP €
PRO LIGHT BLACK	XS/S	37/39	BG175038	3	43,74	39,37	34,99	69,99
PRO LIGHT BLACK	S/M	40/41	BG175040	3	43,74	39,37	34,99	69,99
PRO LIGHT BLACK	M/L	41/43	BG175042	3	43,74	39,37	34,99	69,99
PRO LIGHT BLACK	L/XL	44/45	BG175044	3	43,74	39,37	34,99	69,99
PRO LIGHT BLACK	XL/2XL	46/47	BG175046	3	43,74	39,37	34,99	69,99
PRO LIGHT BLACK/BLUE	XS/S	37/39	BG172038	3	43,74	39,37	34,99	69,99
PRO LIGHT BLACK/BLUE	S/M	40/41	BG172040	3	43,74	39,37	34,99	69,99
PRO LIGHT BLACK/BLUE	M/L	41/43	BG172042	3	43,74	39,37	34,99	69,99
PRO LIGHT BLACK/BLUE	L/XL	44/45	BG172044	3	43,74	39,37	34,99	69,99
PRO LIGHT BLACK/YELLOW	XS/S	37/39	BG171038	3	43,74	39,37	34,99	69,99
PRO LIGHT BLACK/YELLOW	S/M	40/41	BG171040	3	43,74	39,37	34,99	69,99
PRO LIGHT BLACK/YELLOW	M/L	41/43	BG171042	3	43,74	39,37	34,99	69,99
PRO LIGHT BLACK/YELLOW	L/XL	44/45	BG171044	3	43,74	39,37	34,99	69,99
PRO LIGHT SILVER	XS/S	37/39	WBG175138	3	43,74	39,37	34,99	69,99
PRO LIGHT SILVER	S/M	40/41	WBG175140	3	43,74	39,37	34,99	69,99
PRO LIGHT SILVER	M/L	41/43	WBG175142	3	43,74	39,37	34,99	69,99
PRO LIGHT SILVER	L/XL	44/45	WBG175144	3	43,74	39,37	34,99	69,99
PRO LIGHT PINK	XS/S	37/39	WBG174038	3	43,74	39,37	34,99	69,99
PRO LIGHT PINK	S/M	40/41	WBG174040	3	43,74	39,37	34,99	69,99



BLACK



BLACK/BLUE



BLACK/YELLOW



SILVER



PINK



OPTIONAL EBS STRAP



# FROG

## SCUBA FINS

A classic in the Cressi range, this has been on the market for many years and has a huge number of appreciators in every corner of the planet. The fin is made with a skilful combination of a strong copolymer and a soft elastomer, the latter used for the foot pocket, for the side stringers and for some inserts.

The blade originates from the upper part of the foot pocket, with a 20% increase in useful surface area compared to a traditional fin of the same length. The foot pocket is computer designed and offers great comfort; it guarantees excellent transmission of the leg-fin thrust. The Frog is heavier than the

more recently designed equivalent Cressi models. It is this feature that makes it agreeable to whoever uses very thick suits or watertight suits. Anyone who works underwater will appreciate this fin a great deal because it is strong and comfortable, very popular also in diving schools and excellent for rental



PRODUCT	SIZE	EU	CODE	PACK	DLR €	10%	SEASONAL ORDER 20%	RRP €
FROG BLACK	XS/S	36/39	BF195038	3	66.24	59.62	52.99	109.99
FROG BLACK	S/M	39/42	BF195040	3	66.24	59.62	52.99	109.99
FROG BLACK	M/L	42/45	BF195042	3	66.24	59.62	52.99	109.99
FROG BLACK	L/XL	45/47	BF195044	3	66.24	59.62	52.99	109.99
FROG BLACK/RED	XS/S	36/39	JBF195838	3	66.24	59.62	52.99	109.99
FROG BLACK/RED	S/M	39/42	JBF195840	3	66.24	59.62	52.99	109.99
FROG BLACK/RED	M/L	42/45	JBF195842	3	66.24	59.62	52.99	109.99
FROG BLACK/RED	L/XL	45/47	JBF195844	3	66.24	59.62	52.99	109.99

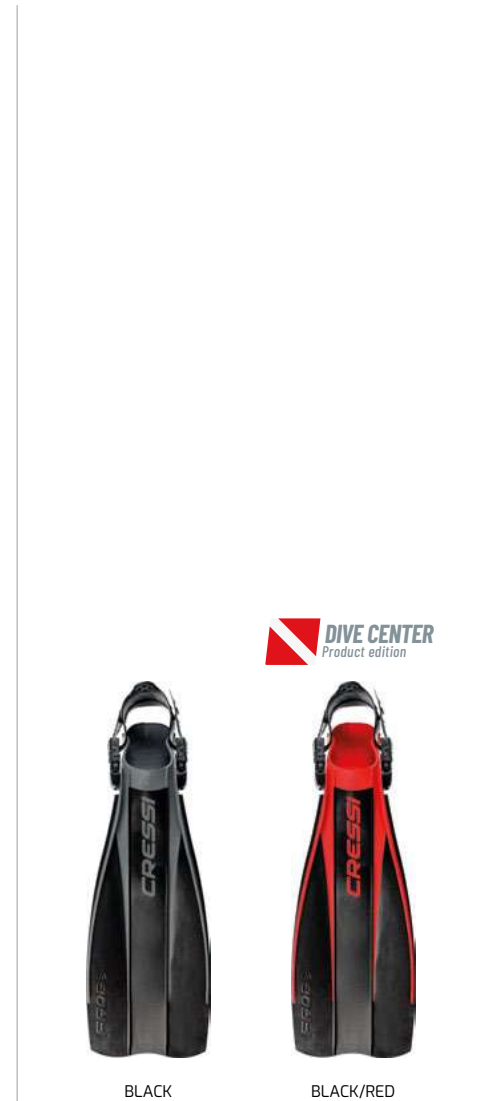

# FREE FROG NEW COLOR 2023

## FULL FOOT FINS

The Free Frog is back! The fin has been remade with the new molding technology. The foot pocket has been improved to fit better to most different foot shapes. The Free Frog enjoys the exclusive characteristics of the Cressi diving fins maintaining the spirit

of the legendary Frog. It features a below blade foot pocket in order to have a bigger surface that increasing the kicking thrust. It is manufactured in a variant of low-modulus polypropylene that, combined with a particular structure, combines great flexibility, softness, and

resistance to a demanding use (even as in rent and school in a diving center), durability and an unprecedented aesthetics in fins projected with this philosophy.



BLACK

BLUE



BLACK/RED

PRODUCT	EU	CODE	PACK	DLR €	10%	SEASONAL ORDER 20%	RRP €
FREE FROG BLACK	37/38	BR155037	3	43,74	39,37	34,99	69,99
FREE FROG BLACK	39/40	BR155039	3	43,74	39,37	34,99	69,99
FREE FROG BLACK	41/42	BR155041	3	43,74	39,37	34,99	69,99
FREE FROG BLACK	43/44	BR155043	3	43,74	39,37	34,99	69,99
FREE FROG BLACK	45/46	BR155045	3	43,74	39,37	34,99	69,99
FREE FROG BLUE	37/38	BR152237	3	43,74	39,37	34,99	69,99
FREE FROG BLUE	39/40	BR152239	3	43,74	39,37	34,99	69,99
FREE FROG BLUE	41/42	BR152241	3	43,74	39,37	34,99	69,99
FREE FROG BLUE	43/44	BR152243	3	43,74	39,37	34,99	69,99
FREE FROG BLUE	45/46	BR152245	3	43,74	39,37	34,99	69,99
FREE FROG BLACK/RED	37/38	JBR155837	3	43,74	39,37	34,99	69,99
FREE FROG BLACK/RED	39/40	JBR155839	3	43,74	39,37	34,99	69,99
FREE FROG BLACK/RED	41/42	JBR155841	3	43,74	39,37	34,99	69,99
FREE FROG BLACK/RED	43/44	JBR155843	3	43,74	39,37	34,99	69,99
FREE FROG BLACK/RED	45/46	JBR155845	3	43,74	39,37	34,99	69,99

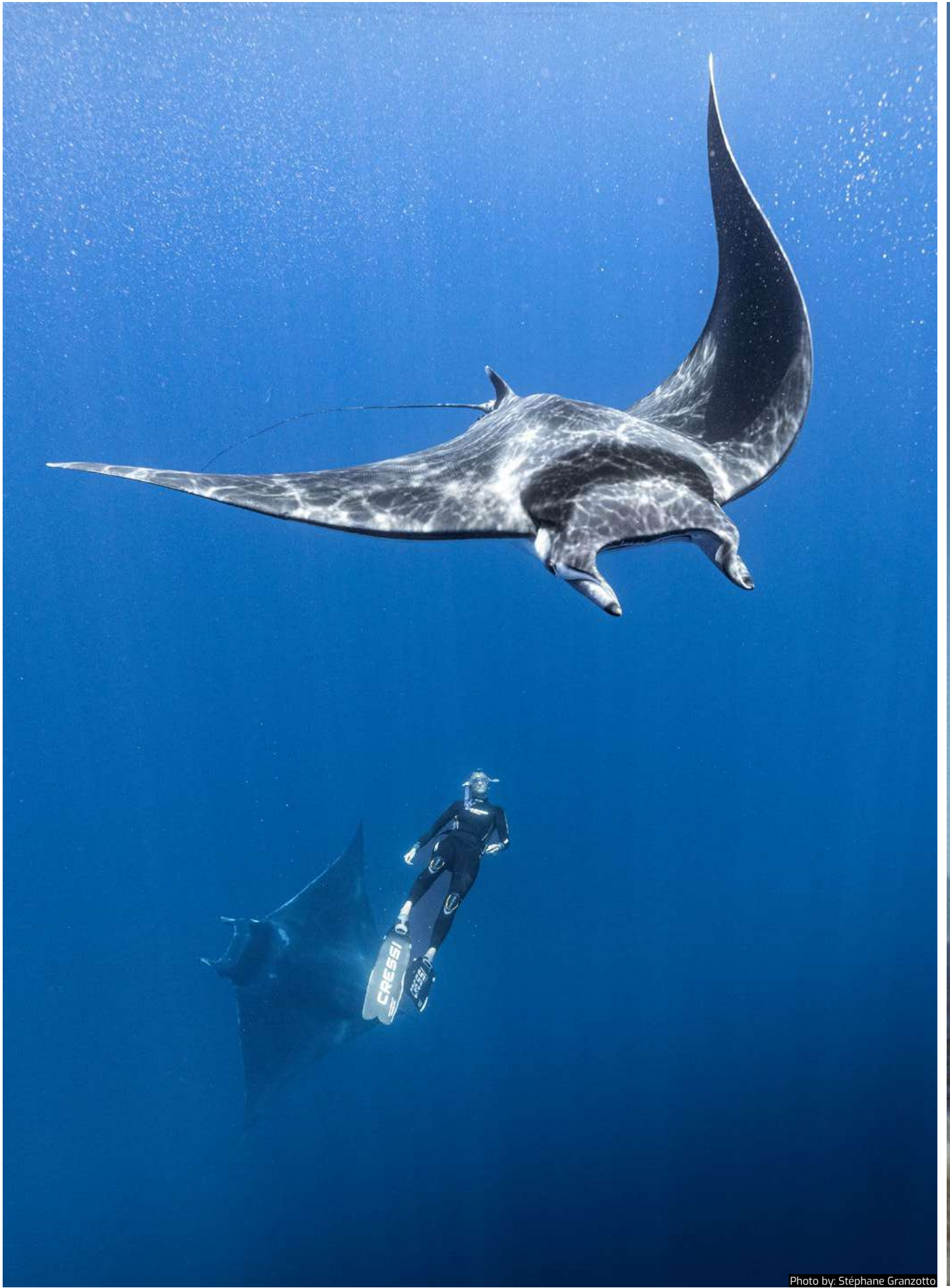

Photo by: Stéphane Granzotto



# GARA



# GARA TURBO CARBON



## HIGH PERFORMANCE COMPACT FIN RAILS

Following the Impulse project we have successfully transferred the same design parameters for S-shaped undulating deformation to this innovative carbon fin. This particular movement permits a notable accumulation of elastic potential energy in the blade, which is released in the return kick, transforming into thrust. The effect has been achieved using a finite elements programme that enables the performance offered by carbonfibre to be exploited to the full. The blade is all-carbonfibre with an angle of 29°. The fibre is imported from Japan. The shaped and processed sheet is then produced in a specialist plant in Turkey. The blade is subsequently finished with an industrial

co-moulding process at Cressi's Genoa plant. The elevated chemical bonding achieved between blade and rail, effectively creating a single piece, has permitted the elimination of the rigid glue that prevented the carbonfibre blade from flexing naturally. The thermoplastic rubber used for the water channelling rails is extremely flexible and soft so as not to undermine the intrinsic characteristics of the carbonfibre. The blade is therefore less fragile and more protected by the rubber. The end result is a very light fin, with every square millimetre exploiting the flexibility of the carbonfibre to the full.

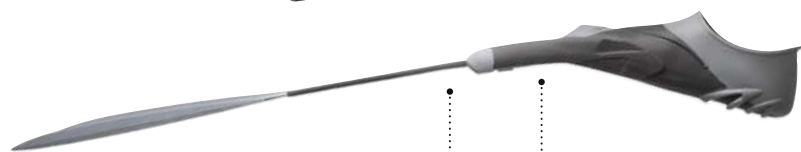

29° DEGREE ANGLED

SHORTER FOOT POCKET

### TECHNICAL FEATURES

- 29 degree angled interchangeable carbon blade
- Modular detachable fin
- Superior performance
- Superior comfort
- Self adjusting foot pocket



GARA TURBO FOOT POCKET



### INCLUDED GARA MODULAR INSOLE

The new insole for Gara Modular fins is recommended for use with thin boots in temperate waters, because it improves the kick performance. The semi-rigid material of the insole is completely recycled. The insoles are supplied as a pair (right and left foot) and can be cut into their shape in three different sizes, according to pre-printed guidelines.

- Down-size Gara Fins foot pocket preformed sole
- Easily adjust size
- Non- corrosive plastic construction



PRODUCT	CODE	DLR €	10%	SEASONAL ORDER 20%	RRP €
GARA TURBO CARBON FINS 36/37	BH165036	312.49	281.24	249.99	449.00
GARA TURBO CARBON FINS 38/39	BH165038	312.49	281.24	249.99	449.00
GARA TURBO CARBON FINS 40/41	BH165040	312.49	281.24	249.99	449.00
GARA TURBO CARBON FINS 42/43	BH165042	312.49	281.24	249.99	449.00
GARA TURBO CARBON FINS 44/45	BH165044	312.49	281.24	249.99	449.00
GARA TURBO CARBON FINS 46/47	BH165046	312.49	281.24	249.99	449.00
INSOLE FOR GARA FINS	BZ180022	11.24	10.12	8.99	19.99





# GARA TURBO CARBON



**SPECIALIZED**  
Retailer-Product

**NEW 2023**

## SUPERIOR PERFORMANCE CAMOUFLAGE FINS

The blades are made with an ultra performing carbon fibre of incredible strength and flexibility. The fabrication of this carbon fiber is done with an high vacuum 100% industrial procedure, to obtain an exceptional compactness of the carbon fibre.

Average carbon fibre used for fin blades in the industry has 3.000 fibers per thread. Our Carbon has 12.000 fibers per thread. Four times as much. Four times the resistance. Four times the flexibility and elasticity, kick response compared to other

carbon blades on the market. Each thread in this carbon fiber is very very small. So small that the TOTAL DENSITY of the blade is an incredible, and unmatched, 20.000 fibers per square millimeter.



**XLD**

High flexibility blade

Dedicated to those divers who prefer a very soft and smooth fin. It is indicated if your fishing sessions include long sessions and if you cover long distances.



**MD**

Medium flexibility blade

It is perfect if you fish using a boat to move from spot to spot, using a constant weight.



**HF**

Stiff blade

It is ideal for strong, powerful athletes with a higher bodyweight. It is also useful in waters with strong currents and when fishing in rougher sea conditions.

SIZE	XLD	MD	HF	DLR €	10%	SEASONAL ORDER 20%	RRP €
36/37	BH167036	BH167536	BH169036	343.74	309.37	274.99	499.99
38/39	BH167038	BH167538	BH169038	343.74	309.37	274.99	499.99
40/41	BH167040	BH167540	BH169040	343.74	309.37	274.99	499.99
42/43	BH167042	BH167542	BH169042	343.74	309.37	274.99	499.99
44/45	BH167044	BH167544	BH169044	343.74	309.37	274.99	499.99
46/47	BH167046	BH167546	BH169046	343.74	309.37	274.99	499.99

### INCLUDED GARA MODULAR INSOLE



The new insole for Gara Modular fins is recommended for use with thin boots in temperate waters, because it improves the kick performance. The semi-rigid material of the insole is completely recycled. The insoles are supplied as a pair (right and left foot) and can be cut into their shape in three different sizes, according to pre-printed guidelines.

- Down-size Gara Fins foot pocket preformed sole
- Easily adjust size
- Non- corrosive plastic construction

### GARA TURBO FOOT POCKET



### TECHNICAL FEATURES

- 29 degree angled interchangeable carbon blade
- Modular detachable fin
- Superior performance
- Superior comfort
- Self adjusting foot pocket

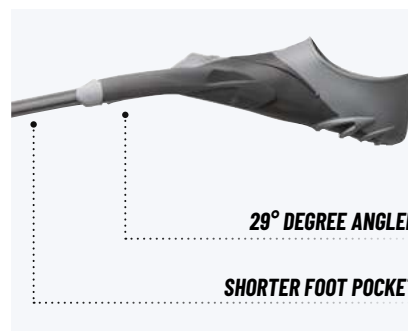



# GARA TURBO IMPULSE

**SPECIALIZED**  
Retailer-Product

NEW COLOR 2023

## HIGH PERFORMANCE COMPACT FIN RAILS

Following the Impulse project we have successfully transferred the same design parameters for S-shaped undulating deformation to this innovative fin. This particular movement permits a notable accumulation of elastic potential energy in the blade, which is released in the return kick,

transforming into thrust. The thermoplastic rubber used for the water channelling rails is extremely flexible and soft so as not to undermine the intrinsic characteristics of the blade.

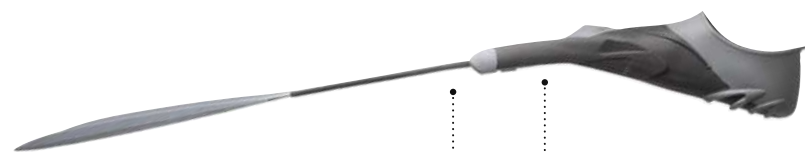

29° DEGREE ANGLED

SHORTER FOOT POCKET

### TECHNICAL FEATURES

- Extremely thin and light blade in compound made of elastomerized technopolymers developed by Cressi
- Stringer consisting of technopolymers with elastomeric loads with high flexural modulus
- Footpocket / blade angle of 29 degrees
- Modular detachable fin
- Superior performance
- Superior comfort
- Self adjusting foot pocket



GARA TURBO FOOT POCKET



BLACK

BLUE

### INCLUDED GARA MODULAR INSOLE

The new insole for Gara Modular fins is recommended for use with thin boots in temperate waters, because it improves the kick performance. The semi-rigid material of the insole is completely recycled. The insoles are supplied as a pair (right and left foot) and can be cut into their shape in three different sizes, according to pre-printed guidelines.

- Down-size Gara Fins foot pocket preformed sole
- Easily adjust size
- Non- corrosive plastic construction



PRODUCT	BLACK	BLUE	DLR €	10%	SEASONAL ORDER 20%	RRP €
GARA TURBO IMPULSE FINS 36/37	BH155036	BH152036	83,74	75,37	66,99	134,99
GARA TURBO IMPULSE FINS 38/39	BH155038	BH152038	83,74	75,37	66,99	134,99
GARA TURBO IMPULSE FINS 40/41	BH155040	BH152040	83,74	75,37	66,99	134,99
GARA TURBO IMPULSE FINS 42/43	BH155042	BH152042	83,74	75,37	66,99	134,99
GARA TURBO IMPULSE FINS 44/45	BH155044	BH152044	83,74	75,37	66,99	134,99
GARA TURBO IMPULSE FINS 46/47	BH155046	BH152046	83,74	75,37	66,99	134,99
INSOLE FOR GARA FINS	BZ180022	-	11,24	10,12	8,99	19,99

# GARA MODULAR IMPULSE

**SPECIALIZED**  
Retailer-Product

INTERCHANGEABLE  
BLADE  
SELF ADJUSTING  
FOOT POCKET

## SUPERIOR PERFORMANCE

The blade of the Gara Modular Impulse completes the range of Cressi fins, inserting a bending angle of 29 degrees, which allows you to further increase the dynamic performance of the fin.

The blade has an incredible resistance to any type of shock, impact or stress, making it almost impossible to break accidentally.



### INCLUDED GARA MODULAR INSOLE

The new insole for Gara Modular fins is recommended for use with thin boots in temperate waters, because it improves the kick performance. The semi-rigid material of the insole is completely recycled. The insoles are supplied as a pair (right and left foot) and can be cut into their shape in three different sizes, according to pre-printed guidelines.

- Down-size Gara Fins foot pocket preformed sole
- Easily adjust size
- Non- corrosive plastic construction



SIZE	BLACK	BLUE METAL	WHITE	DLR €	10%	SEASONAL ORDER 20%	RRP €
36/37	BH095036	BH092036	BH093036	77,49	69,74	61,99	122,99
38/39	BH095038	BH092038	BH093038	77,49	69,74	61,99	122,99
40/41	BH095040	BH092040	BH093040	77,49	69,74	61,99	122,99
42/43	BH095042	BH092042	BH093042	77,49	69,74	61,99	122,99
44/45	BH095044	BH092044	BH093044	77,49	69,74	61,99	122,99
46/47	BH095046	BH092046	BH093046	77,49	69,74	61,99	122,99
INSOLE FOR GARA FINS	BZ180022	-	-	11,24	10,12	8,99	19,99

### TECHNICAL FEATURES

- Excellent propulsive performance without tiring anyone, beginners or professionals
- Extremely thin and light blade in compound made of elastomerized technopolymers developed by Cressi with different thicknesses
- Stringer consisting of technopolymers with elastomeric loads with high flexural modulus
- Footpocket / blade angle of 29 degrees
- Gara Modular's footpocket is wider than the other gara fin models. we suggest to use it with neoprene socks in order to have a proper fit. for use without neoprene socks, we recommend to buy one smaller size

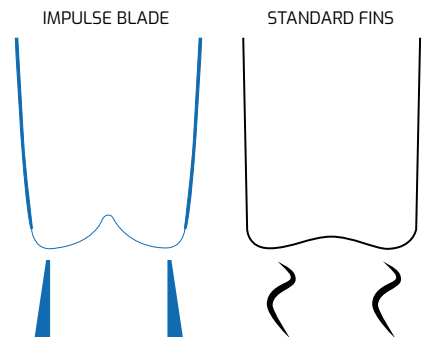

- LIGHTER
- SOFTER
- 100% PROPULSIVE PERFORMANCE
- MORE EFFICIENCY
- LESS EFFORT
- Anti-slip water rails prevent water flow from escaping sideways
- "Rondine" tail special design improves fin control and directionality

# GARA TURBO SPRINT



SHORTER FOOT POCKET | HIGH PROPULSIVE PERFORMANCE  
SHORTER BLADE

## HIGH PERFORMANCE COMPACT FIN RAILS

The new Gara Turbo Sprint fin is a shorter version of the Gara Turbo fin. Sprint is designed to meet the needs of freedivers and spearfishers who practice this sport in wintertime and when a blade as long as Impulse is not necessary. Both fins have been designed using expensive finite element software programs that allow highly complex and equally high-performance sections to be defined. The blade of Sprint, like the Impulse blade, is made

of a single thermoplastic elastomer, although it would be more correct to refer to an angled sublayer and an overlay. The sublayer follows the shape and dimensions of almost the entire fin. It has a uniform thickness and a flexible longitudinal propulsion wing of variable length. When disassembled, the blade and foot pocket occupy the space of a normal snorkeling fin.



### WATER RAILS SYSTEM

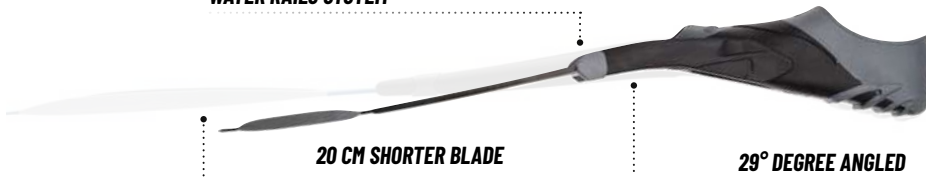

### TECHNICAL FEATURES

- Excellent propulsive performance without tiring anyone, beginners or professionals
- Thermoplastic rubber foot pocket, certified Full Contact
- Standard blade/stringer interface with screws under the foot pocket and side clips
- Extremely thin and light blade in compound made of elastomerized technopolymers developed by Cressi with different thicknesses
- Stringer consisting of technopolymers with elastomeric loads with high flexural modulus
- Foot pocket/blade angle of 29 degrees
- All fin components are also supplied separately.



GARA TURBO FOOT POCKET



### INCLUDED GARA MODULAR INSOLE

The new insole for Gara Modular fins is recommended for use with thin boots in temperate waters, because it improves the kick performance. The semi-rigid material of the insole is completely recycled. The insoles are supplied as a pair (right and left foot) and can be cut into their shape in three different sizes, according to pre-printed guidelines.

- Down-size Gara Fins foot pocket preformed sole
- Easily adjust size
- Non- corrosive plastic construction



PRODUCT	CODE	DLR €	10%	SEASONAL ORDER 20%	RRP €
GARA TURBO SPRINT FINS BLACK 36/37	BH175036	64,99	58,49	51,99	104,99
GARA TURBO SPRINT FINS BLACK 38/39	BH175038	64,99	58,49	51,99	104,99
GARA TURBO SPRINT FINS BLACK 40/41	BH175040	64,99	58,49	51,99	104,99
GARA TURBO SPRINT FINS BLACK 42/43	BH175042	64,99	58,49	51,99	104,99
GARA TURBO SPRINT FINS BLACK 44/45	BH175044	64,99	58,49	51,99	104,99
GARA TURBO SPRINT FINS BLACK 46/47	BH175046	64,99	58,49	51,99	104,99
INSOLE FOR GARA FINS	BZ180022	11,24	10,12	8,99	19,99



# GARA MODULAR SPRINT



- SUPERIOR COMFORT
- SUPERIOR PERFORMANCE
- 29° DEGREE ANGLES INTERCHANGEABLE BLADE
- SELF ADJUSTING FOOT POCKET

## SUPERIOR MANEUVERABILITY

The new Gara Modular Sprint fin is a shorter version of the Impulse fin, which proved to be hugely popular with freedivers worldwide, both amateurs and the most demanding professional freedivers. This is also confirmed by the large number of articles dedicated to it by specialized journalists in sector magazines. Sprint is designed to meet the needs of freedivers and spearfishers who practice this sport in wintertime and when a fin as long as Impulse is not necessary. Both fins have been designed using expensive finite element software programs that allow highly complex and equally high-performance sections to be defined. The blade of Sprint, like the Impulse blade, is made of a single thermoplastic elastomer, although

it would be more correct to refer to an angled sublayer and an overlay. The sublayer follows the shape and dimensions of almost the entire fin. It has a uniform thickness and a flexible longitudinal propulsion wing of variable length. In contrast, the so-called overlay covers the propulsion wing selectively and has a thickness that slopes from the maximum value to zero longitudinally towards the tip of the blade. As a result, the fin offers a new way of storing and releasing elastic potential energy, greatly assisting movement of the freediver's legs and thus guaranteeing a net improvement in propulsive output. When disassembled, the blade and foot pocket occupy the space of a normal snorkeling fin.

### TECHNICAL FEATURES

- Excellent propulsive performance without tiring anyone, beginners or professionals
- Thermoplastic rubber foot pocket, certified Full Contact
- Standard blade/stringer interface with screws under the foot pocket and side clips
- Extremely thin and light blade in compound made of elastomerized technopolymers developed by Cressi with different thicknesses
- Stringer consisting of technopolymers with elastomeric loads with high flexural modulus
- Foot pocket/blade angle of 29 degrees
- All fin components are also supplied separately.



BLUE METAL



BLACK



PRODUCT	BLUE METAL	BLACK	DLR €	10%	SEASONAL ORDER 20%	RRP €
36/37	BH082036	BH085036	61,24	55,12	48,99	99,99
38/39	BH082038	BH085038	61,24	55,12	48,99	99,99
40/41	BH082040	BH085040	61,24	55,12	48,99	99,99
42/43	BH082042	BH085042	61,24	55,12	48,99	99,99
44/45	BH082044	BH085044	61,24	55,12	48,99	99,99
46/47	BH082046	BH085046	61,24	55,12	48,99	99,99
INSOLE FOR GARA FINS	BZ180022	-	11,24	10,12	8,99	19,99



# GARA MODULAR GREY

## SOFTER LD BLADE

The GARA MODULAR GREY is a perfect choice for deep freediving and spearfishing for divers of all levels. The modular design lets the user replace/interchange blades for specific diving purposes, which make the perfect fin to grow with, as the diver can change blades as the divers skills increase. Any standard Fiberglass or Carbon Fiber long blade will interchange in minutes without any modifications to either. The self adjusting footpocket is constructed with the most modern

multi compound joining process to deliver a footpocket that can offer comfort and suppleness around the foot where desired and yet have stiffer compounds under the footpocket and heel area where power transfer takes place. The angle of the blade provides the ultimate in efficiency during the kick cycle requiring less energy to load the blade. Can be comfortably worn with or without neoprene socks.

- SUPERIOR COMFORT
- SUPERIOR PERFORMANCE
- INTERCHANGEABLE BLADE
- SELF ADJUSTING FOOT POCKET

**LONG DISTANCE - SOFTER THERMOPLASTIC BLADE**  
**MINIMUM EFFORT »» MAXIMUM POWER TRANSFER**



### FOOT POCKET

Gara Modular's foot pocket is wider than the other gara fin models. We suggest to use it with neoprene socks in order to have a proper fit. For use without neoprene socks, we recommend to buy one smaller size.



### INCLUDED GARA MODULAR INSOLE

The new insole for Gara Modular fins is recommended for use with thin boots in temperate waters, because it improves the kick performance. The semi-rigid material of the insole is completely recycled. The insoles are supplied as a pair (right and left foot) and can be cut into their shape in three different sizes, according to pre-printed guidelines.

- Down-size Gara Fins foot pocket preformed sole
- Easily adjust size
- Non-corrosive plastic construction



PRODUCT	CODE	PACK	DLR €	10%	SEASONAL ORDER 20%	RRP €
GARA MODULAR FINS GREY 38/39 (5/6)	BH105138	3	69.99	62.99	55.99	114.99
GARA MODULAR FINS GREY 40/41 (7/8)	BH105140	3	69.99	62.99	55.99	114.99
GARA MODULAR FINS GREY 42/43 (8/9)	BH105142	3	69.99	62.99	55.99	114.99
GARA MODULAR FINS GREY 44/45 (10/11)	BH105144	3	69.99	62.99	55.99	114.99
GARA MODULAR FINS GREY 46/47 (12/13)	BH105146	3	69.99	62.99	55.99	114.99
INSOLE FOR GARA FINS	BZ180022	-	11.24	10.12	8.99	19.99

# GARA MODULAR LD

## GREEN CAMOU BLADE

The GARA MODULAR LD is a perfect choice for deep freediving and spearfishing for divers of all levels. The modular design lets the user replace/interchange blades for specific diving purposes, which make the perfect fin to grow with, as the diver can change blades as the divers skills increase. Any standard Fiberglass or Carbon Fiber long blade will interchange in minutes without any modifications to either. The self adjusting footpocket is constructed with the most modern

multi compound joining process to deliver a footpocket that can offer comfort and suppleness around the foot where desired and yet have stiffer compounds under the footpocket and heel area where power transfer takes place. The angle of the blade provides the ultimate in efficiency during the kick cycle requiring less energy to load the blade. Can be comfortably worn with or without neoprene socks.

**LONG DISTANCE - SOFTER THERMOPLASTIC BLADE  
MINIMUM EFFORT »» MAXIMUM POWER TRANSFER**



### FOOT POCKET

Gara Modular's foot pocket is wider than the other gara fin models. We suggest to use it with neoprene socks in order to have a proper fit. For use without neoprene socks, we recommend to buy one smaller size.



PRODUCT	CODE	PACK	DLR €	10%	SEASONAL ORDER 20%	RRP €
GARA MODULAR LD FINS GREEN 38/39 (5/6)	BH109838	3	69,99	62,99	55,99	114,99
GARA MODULAR LD FINS GREEN 40/41 (7/8)	BH109840	3	69,99	62,99	55,99	114,99
GARA MODULAR LD FINS GREEN 42/43 (8/9)	BH109842	3	69,99	62,99	55,99	114,99
GARA MODULAR LD FINS GREEN 44/45 (10/11)	BH109844	3	69,99	62,99	55,99	114,99
GARA MODULAR LD FINS GREEN 46/47 (12/13)	BH109846	3	69,99	62,99	55,99	114,99
INSOLE FOR GARA FINS	BZ180022	-	11,24	10,12	8,99	19,99

- SUPERIOR COMFORT
- SUPERIOR PERFORMANCE
- INTERCHANGEABLE BLADE
- SELF ADJUSTING FOOT POCKET

### TOTAL LENGTH

SIZE	CM	IN
38/39 (5/6)	85	33,50
40/41 (7/8)	86	33,90
42/43 (8/9)	88	34,60
44/45 (10/11)	89,50	35,20
46/47 (12/13)	90,50	35,60

### BLADE LENGTH

SIZE	CM	IN
38/39 (5/6)	76	29,90
40/41 (7/8)	76	29,90
42/43 (8/9)	76	29,90
44/45 (10/11)	76	29,90
46/47 (12/13)	76	29,90

### MAX WIDTH

SIZE	CM	IN
38/39 (5/6)	21,50	8,50
40/41 (7/8)	21,50	8,50
42/43 (8/9)	21,50	8,50
44/45 (10/11)	21,50	8,50
46/47 (12/13)	21,50	8,50

### SINGLE FIN WEIGHT

SIZE	GR	LB
38/39 (5/6)	890	1,96
40/41 (7/8)	940	2,07
42/43 (8/9)	990	2,18
44/45 (10/11)	1040	2,29
46/47 (12/13)	1135	2,50



### INCLUDED GARA MODULAR INSOLE

The new insole for Gara Modular fins is recommended for use with thin boots in temperate waters, because it improves the kick performance. The semi-rigid material of the insole is completely recycled. The insoles are supplied as a pair (right and left foot) and can be cut into their shape in three different sizes, according to pre-printed guidelines.

- Down-size Gara Fins foot pocket preformed sole
- Easily adjust size
- Non- corrosive plastic construction





# GARA MODULAR FOOT POCKET

## SELF ADJUSTING FOOT POCKET

SIZE	CODE	DLR €	10%	SEASONAL ORDER 20%	RRP €
36/37 (3/4)	BH005036	53,13	47,82	42,50	83,89
38/39 (5/6)	BH005038	53,13	47,82	42,50	83,89
40/41 (7/8)	BH005040	53,13	47,82	42,50	83,89
42/43 (8/9)	BH005042	53,13	47,82	42,50	83,89
44/45 (10/11)	BH005044	53,13	47,82	42,50	83,89
46/47 (12/13)	BH005046	53,13	47,82	42,50	83,89



# GARA TURBO FOOT POCKET

## HIGH PERFORMANCE COMPACT FIN RAILS

SIZE	CODE	DLR €	10%	SEASONAL ORDER 20%	RRP €
36/37 (3/4)	BH015036	56,24	50,62	44,99	89,99
38/39 (5/6)	BH015038	56,24	50,62	44,99	89,99
40/41 (7/8)	BH015040	56,24	50,62	44,99	89,99
42/43 (8/9)	BH015042	56,24	50,62	44,99	89,99
44/45 (10/11)	BH015044	56,24	50,62	44,99	89,99
46/47 (12/13)	BH015046	56,24	50,62	44,99	89,99



# GARA ASSEMBLY KIT

## ASSEMBLY KIT FOR GARA FINS

PRODUCT	CODE	DLR €	10%	SEASONAL ORDER 20%	RRP €
ASSEMBLY KIT GARA MODULAR	BZ180020	8,74	7,87	6,99	14,99



# GARA BLADES

**IMPULSE CARBON** 



CARBON    XLD    MD    HF

**IMPULSE** 



BLACK    BLUE METAL    WHITE

**GREY & GREEN LD**



GREY    GREEN LD

FIN (X1)	CODE	DLR €	10%	S.O 20%	RRP €
CARBON	BH077000	124,99	112,49	99,99	199,99
XLD	BH061056	137,49	123,74	109,99	219,99
MD	BH062091	137,49	123,74	109,99	219,99
HF	BH063076	137,49	123,74	109,99	219,99

FIN (X1)	CODE	DLR €	10%	S.O 20%	RRP €
BLACK	BH075000	28,74	25,87	22,99	45,99
BLUE METAL	BH072000	28,74	25,87	22,99	45,99
WHITE	BH073000	28,74	25,87	22,99	45,99

FIN (X1)	CODE	DLR €	10%	S.O 20%	RRP €
GREY	BH055100	21,24	19,12	16,99	33,99
GREEN LD	BH059810	21,24	19,12	16,99	33,99

# GARA 3000 LD

## SOFTER LONG BLADE

GARA 3000 LD is CRESSI's entry-level long blade fin designed with softer blades, which make the GARA 3000 a perfect choice for the beginning diver or those not familiar using long blade fins. The GARA 3000 is constructed with durability in mind and long soft plastic blades that can effectively transfer power with minimum effort, which make this fin very comfortable and easy on the legs for the beginner or during long duration dives.

The GARA 3000 is an extremely comfortable and is a full footpocket style fin. This fin is also constructed using CRESSI's unique three material molding process where different compounds are bonded together to provide flexibility in the foot area and while being able to deliver power thru the blade due to the stiffness that the multi compound molding process can provide. Can comfortably be worn with or without neoprene socks.



### TECHNICAL FEATURES

- Durable construction designed for extended use
- Soft long blade for less swimming effort
- Comfy full footpocket
- Cressi three material molding technology



### TOTAL LENGTH

SIZE	CM	IN
40/41 (7/8)	87	34.28
42/43 (8/9)	88.50	34.87
44/45 (10/11)	90.50	35.66
46/47 (12/13)	92.50	36.45

### BLADE LENGTH

SIZE	CM	IN
40/41 (7/8)	69.50	27.38
42/43 (8/9)	70.50	27.78
44/45 (10/11)	71.50	28.17
46/47 (12/13)	72.50	28.57

### MAX WIDTH

SIZE	CM	IN
40/41 (7/8)	21	8.27
42/43 (8/9)	21	8.27
44/45 (10/11)	21.50	8.47
46/47 (12/13)	22.50	8.87

### SINGLE FIN WEIGHT

SIZE	GR	LB
40/41 (7/8)	925	2.04
42/43 (8/9)	980	2.16
44/45 (10/11)	1070	2.36
46/47 (12/13)	1165	2.57

PRODUCT	CODE	PACK	DLR €	10%	SEASONAL ORDER 20%	RRP €
GARA 3000 LD FINS SILVER 40/41 (7/8)	BH135140	3	68.74	61.87	54.99	109.99
GARA 3000 LD FINS SILVER 42/43 (8/9)	BH135142	3	68.74	61.87	54.99	109.99
GARA 3000 LD FINS SILVER 44/45 (10/11)	BH135144	3	68.74	61.87	54.99	109.99
GARA 3000 LD FINS SILVER 46/47 (12/13)	BH135146	3	68.74	61.87	54.99	109.99



# GARA 2000 HF

## STIFF LONG BLADE

GARA 2000 HF is a staple in the diving industry, and is the first fin in the industry to be manufactured using a three material molding process. Due to its lightweight and durability, it is an excellent choice for those looking for a fin that can provide the ultimate in performance while deep freediving and spearfishing, and those looking for obtaining maximum depths. The GARA 2000 has the stiffest blade in the CRESSI line and is an

extremely comfortable full footpocket style fin, with long firm blades with built in stringers and runners to effectively direct water flow down the blade aiding in efficiency. This fin is constructed using multiple compounds bonded together to provide comfort and suppleness in the foot area and strength and rigidity in the heel and blade area. Can comfortably be worn with or without neoprene socks.

SUPERIOR COMFORT | SUPERIOR PERFORMANCE | HIGH FREQUENCY



### TECHNICAL FEATURES

- Stiff long blade designed for reach max depths
- Comfy full foot pocket
- High performance long blade



### TOTAL LENGTH

SIZE	CM	IN
40/41 (7/8)	84.50	33.29
42/43 (8/9)	86	33.88
44/45 (10/11)	87.50	34.48
46/47 (12/13)	89	35.07

### BLADE LENGTH

SIZE	CM	IN
40/41 (7/8)	66	26
42/43 (8/9)	66	26
44/45 (10/11)	67.50	26.60
46/47 (12/13)	67.50	26.60

### MAX WIDTH

SIZE	CM	IN
40/41 (7/8)	21.50	8.47
42/43 (8/9)	21.50	8.47
44/45 (10/11)	22	8.67
46/47 (12/13)	22.30	8.79

### SINGLE FIN WEIGHT

SIZE	GR	LB
40/41 (7/8)	790	1.74
42/43 (8/9)	895	1.97
44/45 (10/11)	970	2.14
46/47 (12/13)	1030	2.27

PRODUCT	CODE	PACK	DLR €	10%	SEASONAL ORDER 20%	RRP €
GARA 2000 HF FINS BLACK 40/41 (7/8)	BH115040	3	62.49	56.24	49.99	99.99
GARA 2000 HF FINS BLACK 42/43 (8/9)	BH115042	3	62.49	56.24	49.99	99.99
GARA 2000 HF FINS BLACK 44/45 (10/11)	BH115044	3	62.49	56.24	49.99	99.99
GARA 2000 HF FINS BLACK 46/47 (12/13)	BH115046	3	62.49	56.24	49.99	99.99





# GARA PROFESSIONAL LD

## LONG DISTANCE

The Gara Professional LD is a high performance fin, requiring minimum effort to load the long blades. They are more forgiving than other long blade fins for untrained legs, making this an excellent choice for deep free divers and spearfishers of all levels. They are ideal for long distance swimming, while ultimately providing the power and efficiency needed for deep free-diving and spearfishing. Due to the multi compound bonding process used

during the manufacturing process, the Gara Pro LD is an exceptionally soft full footpocket style fin, which provides comfort during prolonged use on those long days in the water. Gara Pro LD delivers maximum power with minimum energy through its long firm blade that runs over the footpocket. Can comfortably be worn with or without neoprene socks.



### TOTAL LENGTH

SIZE	CM	IN
40/41 (7/8)	87	34.28
42/43 (8/9)	89	35.07
44/45 (10/11)	90	35.46
46/47 (12/13)	91.50	36.05

### BLADE LENGTH

SIZE	CM	IN
40/41 (7/8)	73	28.76
42/43 (8/9)	75	29.55
44/45 (10/11)	75	29.55
46/47 (12/13)	77	30.34

### MAX WIDTH

SIZE	CM	IN
40/41 (7/8)	22	8.67
42/43 (8/9)	22.50	8.87
44/45 (10/11)	23.30	9.18
46/47 (12/13)	24.20	9.53

### SINGLE FIN WEIGHT

SIZE	GR	LB
40/41 (7/8)	890	1.96
42/43 (8/9)	960	2.12
44/45 (10/11)	990	2.18
46/47 (12/13)	1055	2.33

PRODUCT	CODE	PACK	DLR €	10%	SEASONAL ORDER 20%	RRP €
GARA PROFESSIONAL LD FINS SILVER 40/41 (7/8)	BH145140	3	49.99	44.99	39.99	84.99
GARA PROFESSIONAL LD FINS SILVER 42/43 (8/9)	BH145142	3	49.99	44.99	39.99	84.99
GARA PROFESSIONAL LD FINS SILVER 44/45 (10/11)	BH145144	3	49.99	44.99	39.99	84.99
GARA PROFESSIONAL LD FINS SILVER 46/47 (12/13)	BH145146	3	49.99	44.99	39.99	84.99





Photo by: Kayleigh and Cameron Grant



Photo by: Kayleigh and Cameron Grant





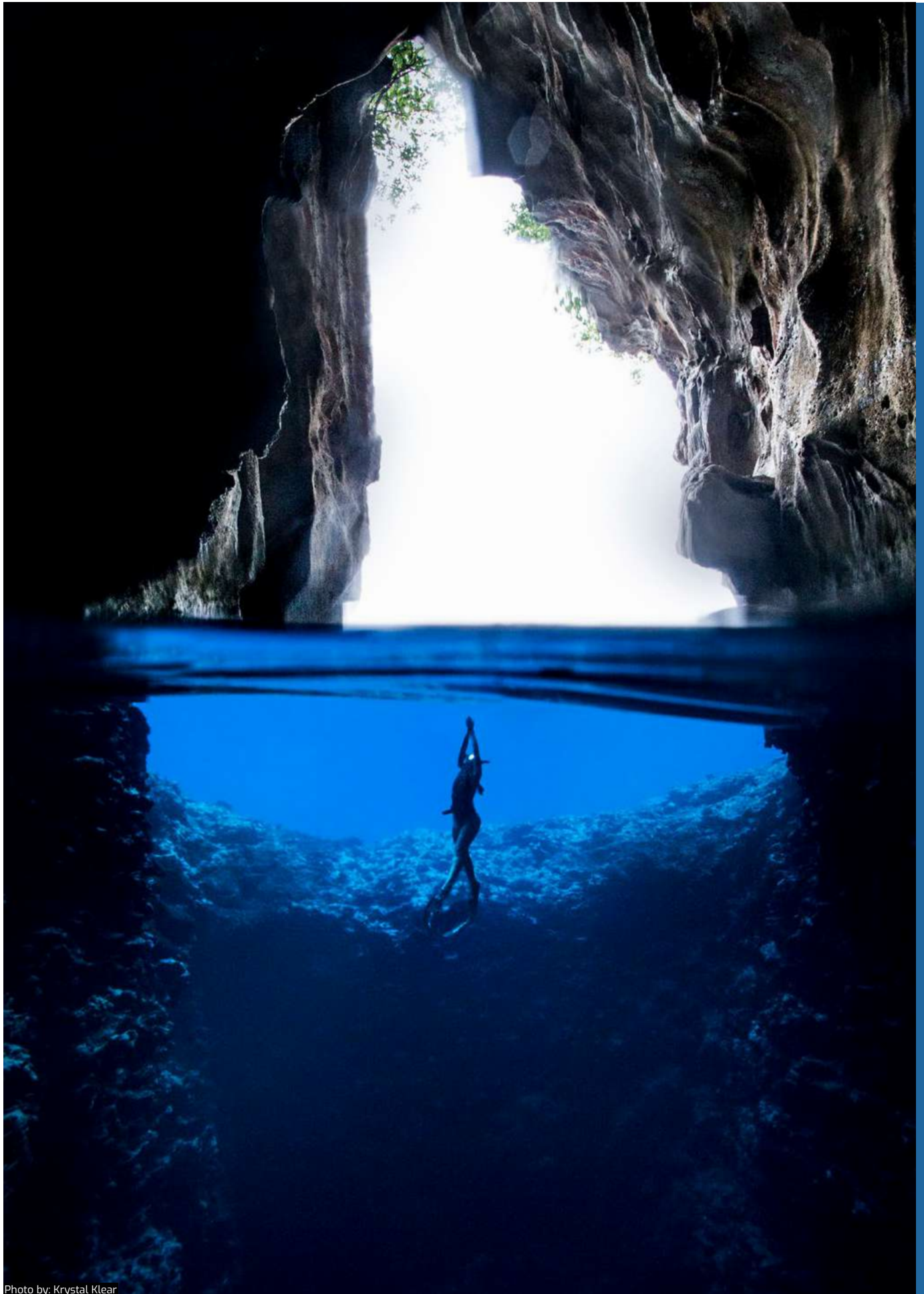

Photo by: Krystal Klear



# REACTION PRO

## FULL FOOT FINS

REACTION PRO is a great all around fin for scuba, snorkeling and freediving. The REACTION PRO is a full foot pocket style fin, with a longer blade and built in runners to effectively direct water flow down the blade. REACTION PRO is constructed using multiple materials bonded together with a patented three material molding process to

provide comfort and suppleness in the foot area and strength and rigidity in the heel and blade area, where the foot pocket is beneath the blade for added power and efficiency. The soles are completely covered in thermo-rubber to give them exceptional grip on boat decks. Can comfortably be worn with or without neoprene socks.



### TECHNICAL FEATURES

- Full foot pocket for comfort
- Long blade for efficiency
- Thermo-Rubber soles for extra grip on wet surfaces



BLUE/AZURE



BLACK/SILVER



YELLOW/SILVER

### TOTAL LENGTH

SIZE	CM	IN
36/37 (3/4)	60	23.64
38/39 (5/6)	62	24.43
40/41 (7/8)	64	25.22
42/43 (8/9)	66.5	26.2
44/45 (10/11)	68	26.79
46/47 (12/13)	70	27.58

### BLADE LENGTH

SIZE	CM	IN
36/37 (3/4)	47.5	18.72
38/39 (5/6)	49.5	19.5
40/41 (7/8)	50	19.7
42/43 (8/9)	52	20.49
44/45 (10/11)	54.5	21.47
46/47 (12/13)	55.5	21.87

### MAX WIDTH

SIZE	CM	IN
36/37 (3/4)	20.3	8
38/39 (5/6)	21	8.27
40/41 (7/8)	21.5	8.47
42/43 (8/9)	22.5	8.87
44/45 (10/11)	23	9.06
46/47 (12/13)	23.7	9.34

### SINGLE FIN WEIGHT

SIZE	GR	LB
36/37 (3/4)	625	1.38
38/39 (5/6)	710	1.57
40/41 (7/8)	765	1.69
42/43 (8/9)	830	1.83
44/45 (10/11)	880	1.94
46/47 (12/13)	935	2.06

PRODUCT	EU	CODE	PACK	DLR €	10%	SEASONAL ORDER 20%	RRP €
REACTION PRO BLUE/AZURE	36/37	BG192036	3	41.24	37.12	32.99	65.99
REACTION PRO BLUE/AZURE	38/39	BG192038	3	41.24	37.12	32.99	65.99
REACTION PRO BLUE/AZURE	40/41	BG192040	3	41.24	37.12	32.99	65.99
REACTION PRO BLUE/AZURE	42/43	BG192042	3	41.24	37.12	32.99	65.99
REACTION PRO BLUE/AZURE	44/45	BG192044	3	41.24	37.12	32.99	65.99
REACTION PRO BLUE/AZURE	46/47	BG192046	3	41.24	37.12	32.99	65.99
REACTION PRO BLACK/SILVER	36/37	BG195036	3	41.24	37.12	32.99	65.99
REACTION PRO BLACK/SILVER	38/39	BG195038	3	41.24	37.12	32.99	65.99
REACTION PRO BLACK/SILVER	40/41	BG195040	3	41.24	37.12	32.99	65.99
REACTION PRO BLACK/SILVER	42/43	BG195042	3	41.24	37.12	32.99	65.99
REACTION PRO BLACK/SILVER	44/45	BG195044	3	41.24	37.12	32.99	65.99
REACTION PRO BLACK/SILVER	46/47	BG195046	3	41.24	37.12	32.99	65.99
REACTION PRO YELLOW/SILVER	36/37	BG191036	3	41.24	37.12	32.99	65.99
REACTION PRO YELLOW/SILVER	38/39	BG191038	3	41.24	37.12	32.99	65.99
REACTION PRO YELLOW/SILVER	40/41	BG191040	3	41.24	37.12	32.99	65.99
REACTION PRO YELLOW/SILVER	42/43	BG191042	3	41.24	37.12	32.99	65.99
REACTION PRO YELLOW/SILVER	44/45	BG191044	3	41.24	37.12	32.99	65.99
REACTION PRO YELLOW/SILVER	46/47	BG191046	3	41.24	37.12	32.99	65.99

# PRO STAR

## FULL FOOT FINS

PRO STAR is yet another versatile fin in the CRESSI line and is an exceptional choice for Scuba, Snorkeling and Freediving. Inspired by the PRO LIGHT, The PRO STAR is a lightweight and comfortable full foot pocket style fin. For power transference, it incorporates the blade beneath the foot pocket and the angle of the blade provides

the ultimate in efficiency during the kick cycle requiring less energy to load the blade. This fin is constructed using multiple compounds bonded together to provide comfort around the foot, yet strong enough to transfer strength where needed. Can comfortably be worn with or without neoprene socks.



### TECHNICAL FEATURES

- Full foot pocket for comfort
- Long blade for efficiency



BLACK



YELLOW

### TOTAL LENGTH

SIZE	CM	IN
37/38 (4/5)	60	23.64
39/40 (5.5/6.5)	62.5	24.63
41/42 (7/8)	64.5	25.41
43/44 (8.5/9.5)	66.5	26.2
45/46 (10/11)	68.5	26.99

### BLADE LENGTH

SIZE	CM	IN
37/38 (4/5)	50	19.7
39/40 (5.5/6.5)	50.5	19.9
41/42 (7/8)	52	20.49
43/44 (8.5/9.5)	54.5	21.47
45/46 (10/11)	56.5	22.26

### MAX WIDTH

SIZE	CM	IN
37/38 (4/5)	20	7.88
39/40 (5.5/6.5)	20.5	8.08
41/42 (7/8)	21	8.27
43/44 (8.5/9.5)	21.5	8.47
45/46 (10/11)	22	8.67

### SINGLE FIN WEIGHT

SIZE	CM	IN
37/38 (4/5)	575	1.27
39/40 (5.5/6.5)	615	1.36
41/42 (7/8)	645	1.42
43/44 (8.5/9.5)	710	1.57
45/46 (10/11)	790	1.74

PRODUCT	EU	CODE	PACK	DLR €	10%	SEASONAL ORDER 20%	RRP €
PRO STAR BLACK	37/38	BG185037	4	33.74	30.37	26.99	55.99
PRO STAR BLACK	39/40	BG185039	4	33.74	30.37	26.99	55.99
PRO STAR BLACK	41/42	BG185041	4	33.74	30.37	26.99	55.99
PRO STAR BLACK	43/44	BG185043	4	33.74	30.37	26.99	55.99
PRO STAR BLACK	45/46	BG185045	4	33.74	30.37	26.99	55.99
PRO STAR YELLOW	37/38	BG181037	4	33.74	30.37	26.99	55.99
PRO STAR YELLOW	39/40	BG181039	4	33.74	30.37	26.99	55.99
PRO STAR YELLOW	41/42	BG181041	4	33.74	30.37	26.99	55.99
PRO STAR YELLOW	43/44	BG181043	4	33.74	30.37	26.99	55.99
PRO STAR YELLOW	45/46	BG181045	4	33.74	30.37	26.99	55.99

# MAUI

## OPEN HEEL SNORKELING FINS

The principal characteristics of the Maui fin are lightness and ease of use, even for those without well-trained legs. Its weight and dimensions make it easy to stow, but without compromising performance.

The Maui has been designed with the same sophisticated and advanced finite elements technology used for the first time on the Impulse and Sprint models.

The dual material technology used for the blade means that it is substantially composed of two rigid lateral wings that direct the flow of water

to the central section, where the overlaying of a softer and more elastic material makes it more flexible. In this way the blade flexes to create a "spoon effect", thereby contributing considerable propulsive force.

The fin can be used with bare feet or light socks. The fabric covering of the EBS strap prevents perishing of the elastic elements.

The heel piece is in soft, anatomical rubber. The grab handle for fitting the fin wraps around the ankle so as to reduce protrusion and avoid chafing

while swimming.

Even though the EBS itself permits great adaptability and makes donning the fin particularly easy, we have fitted a cleat to the elastic strap to permit further adjustment. This function permits the user to obtain micro-adjustments – depending on whether they are wearing a sock or not – or simply to loosen or tighten to ensure the foot is held firmly in place but without excessive pressure. Dive Centres fins will have heel pieces colour-coded according to sizes to facilitate identification.



**DIVE CENTER**  
Product edition



BLACK/BLUE



BLACK/RED

### EBS STRAPS FOR DIVE CENTER VERSION

Dive Centers Maui fins will have heel pieces colour-coded according to sizes to facilitate identification:



S/M  
RED STRAP

M/L  
BLACK STRAP

L/XL  
GREY STRAP

### MAUI BLUE FINS



ALL SIZES  
BLUE STRAP

PRODUCT	SIZE	CODE	PACK	DLR €	10%	SEASONAL ORDER 20%	RRP €
MAUI FINS BLACK/BLUE	S/M	CA155238	6	44,99	40,49	35,99	71,99
MAUI FINS BLACK/BLUE	M/L	CA155241	6	44,99	40,49	35,99	71,99
MAUI FINS BLACK/BLUE	L/XL	CA155244	6	44,99	40,49	35,99	71,99
EBS STRAPS MAUI BLUE (2pcs)	-	CZ145200	-	16,24	14,62	12,99	25,99
PRODUCT	SIZE	CODE	PACK	DLR €	10%	SEASONAL ORDER 20%	RRP €
MAUI FINS DIV-CEN BLACK/RED	S/M	CA155838	6	44,99	40,49	35,99	71,99
MAUI FINS DIV-CEN BLACK/RED	M/L	CA155841	6	44,99	40,49	35,99	71,99
MAUI FINS DIV-CEN BLACK/RED	L/XL	CA155844	6	44,99	40,49	35,99	71,99
EBS STRAPS MAUI GREY (2pcs)	-	CZ145550	-	16,24	14,62	12,99	25,99
EBS STRAPS MAUI BLACK (2pcs)	-	CZ145500	-	16,24	14,62	12,99	25,99
EBS STRAPS MAUI RED (2pcs)	-	CZ145800	-	16,24	14,62	12,99	25,99





# MAUI SHORT

NEW 2023

## OPEN HEEL SNORKELING FINS

Maui short is a short fin, ideal for swimming in open and confined waters, and for snorkeling. For its robustness and practicality, is the ideal fin for safety and rescue teams operating on beaches. Maui short has been developed using the same calculation programs that we used to design on Impulse and Sprint fins, and on her "big sister" Maui. Two side rails, built in two different materials, convey the water towards the central part of the blade. The combination of a softer material and a stiffer one makes this fin extremely soft and

extremely performing at the same time. When the blade flexes it creates a "spoon" effect and bouncing back in position it emits a great propelling power in return.

The strap is built using an EBS system made of elastic rubbers, with a nylon lining, that guarantees a very long duration and resistance to abrasion. The heel is made of soft rubber, cut in an anatomic shape. This fin can be used with or without neoprene socks.

The handle is wrapped around the heel, so that it does not interfere with the movement of legs and feet when swimming. The EBS system is very stable on its own, but we added a choker on the elastic bands to allow a fine tuning of the fin and to avoid an unwanted release.

Maui short is a fin for swimming in the sea or in the swimming-pool, it can be used for snorkeling and it's the fin of choice for rescue teams operating on beaches.



MAUI EBS STRAP



PRODUCT	SIZE	CODE	PACK	DLR €	10%	SEASONAL ORDER 20%	RRP €
MAUI SHORT FINS BLACK/BLUE	S/M	CA165238	6	44,99	40,49	35,99	71,99
MAUI SHORT FINS BLACK/BLUE	M/L	CA165241	6	44,99	40,49	35,99	71,99
MAUI SHORT FINS BLACK/BLUE	L/XL	CA165244	6	44,99	40,49	35,99	71,99
EBS STRAPS MAUI BLUE (2pcs)	-	CZ145200	-	16,24	14,62	12,99	25,99

# PALAU

## OPEN HEEL SNORKELING FINS

These open heel snorkel fins are made for use with bare feet and provide outstanding comfort and versatility. The open-heel design means each fin can accommodate a wider range of sizes, so family members or friends can share equipment more easily. It also allows dive schools or rental

departments to stock fewer sizes while providing very high-quality fins to customers. The Palau's blade delivers excellent thrust with a modest kicking effort. snorkelling, free diving, and long swims.

### TECHNICAL FEATURES

- Open heel foot pocket designed for bare feet
- Soft elastomer material delivers outstanding comfort
- Ideal for sharing among family and friends or for rental departments
- Easy-kicking blade responds well to any kicking style
- Blade extends from the top of the foot pocket for maximum surface area
- 5 fin sizes cover shoe sizes from 32 to 47 (European).



BLUE/AZURE

BLACK/YELLOW

BLACK/PINK

PRODUCT	SIZE	EU	CODE	PACK	DLR €	10%	SEASONAL ORDER 20%	RRP €
PALAU BLUE/AZURE	KID	29/32	CA112029	6	24,99	22,49	19,99	41,99
PALAU BLUE/AZURE	2XS/XS	32/35	CA112032	6	24,99	22,49	19,99	41,99
PALAU BLUE/AZURE	XS/S	35/38	CA112035	6	24,99	22,49	19,99	41,99
PALAU BLUE/AZURE	S/M	38/41	CA112038	6	24,99	22,49	19,99	41,99
PALAU BLUE/AZURE	M/L	41/44	CA112041	6	24,99	22,49	19,99	41,99
PALAU BLUE/AZURE	L/XL	44/47	CA112044	6	24,99	22,49	19,99	41,99
PALAU BLACK/YELLOW	2XS/XS	32/35	CA115132	6	24,99	22,49	19,99	41,99
PALAU BLACK/YELLOW	XS/S	35/38	CA115135	6	24,99	22,49	19,99	41,99
PALAU BLACK/YELLOW	S/M	38/41	CA115138	6	24,99	22,49	19,99	41,99
PALAU BLACK/YELLOW	M/L	41/44	CA115141	6	24,99	22,49	19,99	41,99
PALAU BLACK/YELLOW	L/XL	44/47	CA115144	6	24,99	22,49	19,99	41,99
PALAU BLACK/PINK	KID	29/32	CA115429	6	24,99	22,49	19,99	41,99
PALAU BLACK/PINK	2XS/XS	32/35	CA115432	6	24,99	22,49	19,99	41,99
PALAU BLACK/PINK	XS/S	35/38	CA115435	6	24,99	22,49	19,99	41,99
PALAU BLACK/PINK	S/M	38/41	CA115438	6	24,99	22,49	19,99	41,99





IDEAL FOR TRAVEL



MADE IN ITALY

SUPERIOR COMFORT

BELOW BLADE FOOT POCKET

# PALAU SAF

## SHORT BLADE SNORKELING FINS

A true sports fin, the Palau Short Adjustable Fin (SAF) is ideal for active water sports enthusiasts. Short and easy to pack, it's the ultimate travel companion and is suitable for snorkeling,

swimming, body surfing, boogie boards and much more. The soft open-heel foot pockets are designed for bare feet and provide a great fit for multiple sizes.

### TECHNICAL FEATURES

- Open heel foot pocket designed for bare feet
- Soft elastomer material delivers outstanding comfort
- Ideal for sharing among family and friends or for rental departments
- Short blade
- Blade extends from the top of the foot pocket for maximum surface area



PRODUCT	SIZE	EU	CODE	PACK	DLR €	10%	SEASONAL ORDER 20%	RRP €
PALAU SAF BLUE/AZURE	XS/S	35/38	CA132035	6	24.99	22.49	19.99	41.99
PALAU SAF BLUE/AZURE	S/M	38/41	CA132038	6	24.99	22.49	19.99	41.99
PALAU SAF BLUE/AZURE	M/L	41/44	CA132041	6	24.99	22.49	19.99	41.99
PALAU SAF BLUE/AZURE	L/XL	44/47	CA132044	6	24.99	22.49	19.99	41.99
PALAU SAF BLACK/YELLOW	XS/S	35/38	CA135135	6	24.99	22.49	19.99	41.99
PALAU SAF BLACK/YELLOW	S/M	38/41	CA135138	6	24.99	22.49	19.99	41.99
PALAU SAF BLACK/YELLOW	M/L	41/44	CA135141	6	24.99	22.49	19.99	41.99
PALAU SAF BLACK/YELLOW	L/XL	44/47	CA135144	6	24.99	22.49	19.99	41.99
PALAU SAF BLACK/PINK	XS/S	35/38	CA135435	6	24.99	22.49	19.99	41.99
PALAU SAF BLACK/PINK	S/M	38/41	CA135438	6	24.99	22.49	19.99	41.99



BLUE/AZURE



BLACK/YELLOW



BLACK/PINK





# PLUMA

## FULL FOOT SNORKELING FINS

This high-tech fin designed specifically for snorkeling benefits from the best technologies used in free diving and scuba diving. Cressi's unique molding process also allows for the use of three separate materials to create a highly-responsive

blade. Now, snorkelers can power through current and enjoy hours on the water without undue muscle strain. The Pluma's computer-designed foot pocket provides excellent power transmission and unparalleled comfort.

### TECHNICAL FEATURES

- Patented Cressi molding
- Technology used to create lightweight, responsive blade
- Computer designed foot pocket with stiff base better transmits power down the blade
- Soft thermo-rubber foot pocket material is comfortable for extended wear
- Lightweight polypropylene blade is easy to pack
- Blade ribs provide precise flex control for maximum thrust
- Excellent value



BLUE/AZURE



BLACK/SILVER

PRODUCT	EU	CODE	PACK	DLR €	10%	SEASONAL ORDER 20%	RRP €
PLUMA BLUE/AZURE	33/34	CA172033	6	21.24	19.12	16.99	34.99
PLUMA BLUE/AZURE	35/36	CA172035	6	22.49	20.24	17.99	37.99
PLUMA BLUE/AZURE	37/38	CA172037	6	22.49	20.24	17.99	37.99
PLUMA BLUE/AZURE	39/40	CA172039	6	22.49	20.24	17.99	37.99
PLUMA BLUE/AZURE	41/42	CA172041	6	22.49	20.24	17.99	37.99
PLUMA BLUE/AZURE	43/44	CA172043	6	22.49	20.24	17.99	37.99
PLUMA BLUE/AZURE	45/46	CA172045	6	22.49	20.24	17.99	37.99
PLUMA BLACK/SILVER	35/36	CA175035	6	22.49	20.24	17.99	37.99
PLUMA BLACK/SILVER	37/38	CA175037	6	22.49	20.24	17.99	37.99
PLUMA BLACK/SILVER	39/40	CA175039	6	22.49	20.24	17.99	37.99
PLUMA BLACK/SILVER	41/42	CA175041	6	22.49	20.24	17.99	37.99
PLUMA BLACK/SILVER	43/44	CA175043	6	22.49	20.24	17.99	37.99
PLUMA BLACK/SILVER	45/46	CA175045	6	22.49	20.24	17.99	37.99



# AGUA

## FULL FOOT SNORKELING FINS

Agua is a very easy fin to use, and doesn't require any special athletic or water-sport abilities, yet it still delivers excellent performance without tiring your feet. Thanks to the latest technology and

Cressi's experience in developing these products, we've been able to markedly decrease the weight of this fin compared to others in its category, while still preserving excellent responsiveness.

The foot pocket features the original Self Adjusting Foot Pocket system, which thanks to the special softness and elasticity of the blends makes for a consistently soft and adherent fit.

LONG BLADE | ABOVE BLADE FOOT POCKET | SELF ADJUSTING FOOT POCKET



KID SIZE	EU	CODE	PACK	DLR €	10%	SEASONAL ORDER 20%	RRP €
AGUA KID AQUAMARINE	31/32	CA206331	6	19.38	17.44	15.50	30.99
AGUA KID AQUAMARINE	33/34	CA206333	6	19.38	17.44	15.50	30.99
AGUA KID PINK	31/32	CA206431	6	19.38	17.44	15.50	30.99
AGUA KID PINK	33/34	CA206433	6	19.38	17.44	15.50	30.99
ADULT SIZE	EU	CODE	PACK	DLR €	10%	SEASONAL ORDER 20%	RRP €
AGUA BLACK	35/36	CA205035	6	21.24	19.12	16.99	34.99
AGUA BLACK	37/38	CA205037	6	21.24	19.12	16.99	34.99
AGUA BLACK	39/40	CA205039	6	21.24	19.12	16.99	34.99
AGUA BLACK	41/42	CA205041	6	21.24	19.12	16.99	34.99
AGUA BLACK	43/44	CA205043	6	21.24	19.12	16.99	34.99
AGUA BLACK	45/46	CA205045	6	21.24	19.12	16.99	34.99
AGUA BLUE	35/36	CA206235	6	21.24	19.12	16.99	34.99
AGUA BLUE	37/38	CA206237	6	21.24	19.12	16.99	34.99
AGUA BLUE	39/40	CA206239	6	21.24	19.12	16.99	34.99
AGUA BLUE	41/42	CA206241	6	21.24	19.12	16.99	34.99
AGUA BLUE	43/44	CA206243	6	21.24	19.12	16.99	34.99
AGUA BLUE	45/46	CA206245	6	21.24	19.12	16.99	34.99
AGUA YELLOW	35/36	CA201035	6	21.24	19.12	16.99	34.99
AGUA YELLOW	37/38	CA201037	6	21.24	19.12	16.99	34.99
AGUA YELLOW	39/40	CA201039	6	21.24	19.12	16.99	34.99
AGUA YELLOW	41/42	CA201041	6	21.24	19.12	16.99	34.99
AGUA YELLOW	43/44	CA201043	6	21.24	19.12	16.99	34.99
AGUA YELLOW	45/46	CA201045	6	21.24	19.12	16.99	34.99
AGUA AQUAMARINE	35/36	CA206335	6	21.24	19.12	16.99	34.99
AGUA AQUAMARINE	37/38	CA206337	6	21.24	19.12	16.99	34.99
AGUA AQUAMARINE	39/40	CA206339	6	21.24	19.12	16.99	34.99
AGUA AQUAMARINE	41/42	CA206341	6	21.24	19.12	16.99	34.99
AGUA AQUAMARINE	43/44	CA206343	6	21.24	19.12	16.99	34.99
AGUA AQUAMARINE	45/46	CA206345	6	21.24	19.12	16.99	34.99
AGUA PINK	35/36	CA206435	6	21.24	19.12	16.99	34.99
AGUA PINK	37/38	CA206437	6	21.24	19.12	16.99	34.99
AGUA PINK	39/40	CA206439	6	21.24	19.12	16.99	34.99



AQUAMARINE

PINK



BLACK



BLUE



YELLOW



AQUAMARINE



PINK

# RONDINELLA

## FULL FOOT SNORKELING FINS

All of Cressi's fifty-year experience has gone into these fins, which are a modern revival of the successful principles of the glorious light blue rubber Rondine fins. The blade is made from light and at the same time reactive polypropylene

and during moulding is coalesced with a soft, flexible thermo-rubber (elastomer), used for the foot pocket, for the frames and for some inserts. This mix makes the Rondinella fins light and powerful: they are easy to use, not too

demanding, and perform generously at the same time. The computer-designed foot is enveloping and anatomical, making it easy to put them on and perfect for extended use. Rondinella fins are perfect for snorkelling, free diving, and long swims.



KID SIZE	EU	CODE	PACK	DLR €	10%	SEASONAL ORDER 20%	RRP €
RONDINELLA YELLOW	29/30	CA181029	6	16,24	14,62	12,99	25,99
RONDINELLA YELLOW	31/32	CA181031	6	16,24	14,62	12,99	25,99
RONDINELLA YELLOW	33/34	CA181033	6	16,24	14,62	12,99	25,99
RONDINELLA BLUE	29/30	CA182029	6	16,24	14,62	12,99	25,99
RONDINELLA BLUE	31/32	CA182031	6	16,24	14,62	12,99	25,99
RONDINELLA BLUE	33/34	CA182033	6	16,24	14,62	12,99	25,99
RONDINELLA AQUAMARINE	29/30	CA186329	6	16,24	14,62	12,99	25,99
RONDINELLA AQUAMARINE	31/32	CA186331	6	16,24	14,62	12,99	25,99
RONDINELLA AQUAMARINE	33/34	CA186333	6	16,24	14,62	12,99	25,99
ADULT SIZE	EU	CODE	PACK	DLR €	10%	SEASONAL ORDER 20%	RRP €
RONDINELLA YELLOW	35/36	CA181035	6	18,13	16,32	14,50	29,99
RONDINELLA YELLOW	37/38	CA181037	6	18,13	16,32	14,50	29,99
RONDINELLA YELLOW	39/40	CA181039	6	18,13	16,32	14,50	29,99
RONDINELLA YELLOW	41/42	CA181041	6	18,13	16,32	14,50	29,99
RONDINELLA YELLOW	43/44	CA181043	6	18,13	16,32	14,50	29,99
RONDINELLA YELLOW	45/46	CA181045	6	18,13	16,32	14,50	29,99
RONDINELLA BLUE	35/36	CA182035	6	18,13	16,32	14,50	29,99
RONDINELLA BLUE	37/38	CA182037	6	18,13	16,32	14,50	29,99
RONDINELLA BLUE	39/40	CA182039	6	18,13	16,32	14,50	29,99
RONDINELLA BLUE	41/42	CA182041	6	18,13	16,32	14,50	29,99
RONDINELLA BLUE	43/44	CA182043	6	18,13	16,32	14,50	29,99
RONDINELLA BLUE	45/46	CA182045	6	18,13	16,32	14,50	29,99
RONDINELLA BLUE	47/48	CA182047	6	18,13	16,32	14,50	29,99
RONDINELLA AQUAMARINE	35/36	CA186335	6	18,13	16,32	14,50	29,99
RONDINELLA AQUAMARINE	37/38	CA186337	6	18,13	16,32	14,50	29,99
RONDINELLA AQUAMARINE	39/40	CA186339	6	18,13	16,32	14,50	29,99
RONDINELLA AQUAMARINE	41/42	CA186341	6	18,13	16,32	14,50	29,99
RONDINELLA AQUAMARINE	43/44	CA186343	6	18,13	16,32	14,50	29,99
RONDINELLA AQUAMARINE	45/46	CA186345	6	18,13	16,32	14,50	29,99
RONDINELLA AQUAMARINE	47/48	CA186347	6	18,13	16,32	14,50	29,99





# CLIO

## FULL FOOT SNORKELING FINS

Simple to use and highly durable, the Clio is a favorite snorkel fin for anyone on a budget. It combines a responsive blade and soft, easy-to-

don foot pocket and works well for all ages. The Clio's great value also makes it a good choice for dive schools and rental departments.



### TECHNICAL FEATURES

- Responsive blade delivers good power with any kicking style
- Supple, elastomer foot pocket is easy to slip on and off
- Durable and economical, ideal for rental departments

KID SIZE	EU	CODE	PACK	DLR €	10%	SEASONAL ORDER 20%	RRP €
CLIO YELLOW	27/29	CA101027	6	18.74	16.87	14.99	29.99
CLIO YELLOW	30/32	CA101030	6	18.74	16.87	14.99	29.99
CLIO YELLOW	33/34	CA101033	6	18.74	16.87	14.99	29.99
CLIO BLUE	27/29	CA102027	6	18.74	16.87	14.99	29.99
CLIO BLUE	30/32	CA102030	6	18.74	16.87	14.99	29.99
CLIO BLUE	33/34	CA102033	6	18.74	16.87	14.99	29.99
ADULT SIZE	EU	CODE	PACK	DLR €	10%	SEASONAL ORDER 20%	RRP €
CLIO YELLOW	35/36	CA101035	6	20.94	18.85	16.75	34.99
CLIO YELLOW	37/38	CA101037	6	20.94	18.85	16.75	34.99
CLIO YELLOW	39/40	CA101039	6	20.94	18.85	16.75	34.99
CLIO YELLOW	41/42	CA101041	6	20.94	18.85	16.75	34.99
CLIO YELLOW	43/44	CA101043	6	20.94	18.85	16.75	34.99
CLIO YELLOW	45/46	CA101045	6	20.94	18.85	16.75	34.99
CLIO BLUE	35/36	CA102035	6	20.94	18.85	16.75	34.99
CLIO BLUE	37/38	CA102037	6	20.94	18.85	16.75	34.99
CLIO BLUE	39/40	CA102039	6	20.94	18.85	16.75	34.99
CLIO BLUE	41/42	CA102041	6	20.94	18.85	16.75	34.99
CLIO BLUE	43/44	CA102043	6	20.94	18.85	16.75	34.99
CLIO BLUE	45/46	CA102045	6	20.94	18.85	16.75	34.99
CLIO BLUE	47/48	CA102047	6	20.94	18.85	16.75	34.99
CLIO BLACK	35/36	CA105035	6	20.94	18.85	16.75	34.99
CLIO BLACK	37/38	CA105037	6	20.94	18.85	16.75	34.99
CLIO BLACK	39/40	CA105039	6	20.94	18.85	16.75	34.99
CLIO BLACK	41/42	CA105041	6	20.94	18.85	16.75	34.99
CLIO BLACK	43/44	CA105043	6	20.94	18.85	16.75	34.99
CLIO BLACK	45/46	CA105045	6	20.94	18.85	16.75	34.99
CLIO BLACK	47/48	CA105047	6	20.94	18.85	16.75	34.99



# AGUA SHORT

## SHORT BLADE SWIMMING FINS

The Cressi Agua Short Swim Fin is the shorter more versatile version of Cressi's popular Aqua long blade fin. The Agua Short Fin is ideal for travelers and is the perfect swim aid while in the pool or open water. This fin features a self-

adjusting foot pocket for incredible flexibility and comfort. It is perfect for any level of experience and is a must-have on your next vacation or work-out.



KID SIZE	EU	CODE	PACK	DLR €	10%	SEASONAL ORDER 20%	RRP €
AGUA SHORT BLUE	31/32	DP206231	6	21.24	19.12	16.99	34.99
AGUA SHORT BLUE	33/34	DP206233	6	21.24	19.12	16.99	34.99
ADULT SIZE	EU	CODE	PACK	DLR €	10%	SEASONAL ORDER 20%	RRP €
AGUA SHORT BLUE	35/36	DP206235	3	21.24	19.12	16.99	34.99
AGUA SHORT BLUE	37/38	DP206237	3	21.24	19.12	16.99	34.99
AGUA SHORT BLUE	39/40	DP206239	3	21.24	19.12	16.99	34.99
AGUA SHORT BLUE	41/42	DP206241	3	21.24	19.12	16.99	34.99
AGUA SHORT BLUE	43/44	DP206243	3	21.24	19.12	16.99	34.99
AGUA SHORT BLUE	45/46	DP206245	3	21.24	19.12	16.99	34.99
AGUA SHORT BLUE	47/48	DP206247	3	21.24	19.12	16.99	34.99
AGUA SHORT BLACK/SILVER	35/36	DP205035	3	21.24	19.12	16.99	34.99
AGUA SHORT BLACK/SILVER	37/38	DP205037	3	21.24	19.12	16.99	34.99
AGUA SHORT BLACK/SILVER	39/40	DP205039	3	21.24	19.12	16.99	34.99
AGUA SHORT BLACK/SILVER	41/42	DP205041	3	21.24	19.12	16.99	34.99
AGUA SHORT BLACK/SILVER	43/44	DP205043	3	21.24	19.12	16.99	34.99
AGUA SHORT BLACK/SILVER	45/46	DP205045	3	21.24	19.12	16.99	34.99
AGUA SHORT BLACK/SILVER	47/48	DP205047	3	21.24	19.12	16.99	34.99





IDEAL FOR TRAVEL



MADE IN ITALY

ABOVE BLADE FOOT POCKET

# LIGHT

## SHORT BLADE SWIMMING FINS

The Cressi Light are specifically designed for pool use and for swim training, but can also be used adequately for recreational swimming and snorkeling.

The short blade is made of a highly reactive and light material which guarantees agile and effective kicking while not tiring out your legs. The length of the blade has been researched and studied by Cressi to ensure perfect muscle training without

causing cramps or discomfort. The anatomically designed foot pocket is made from soft rubber elastomers, and it houses the foot with a great deal of comfort, even during long swimming sessions.

### WHO IT IS FOR:

The Light Fins have been specifically designed for training and to build up muscles, but they can also be used for recreational swimming and snorkeling.



SOFT ULTRA FLEXIBLE MATERIAL

KID SIZE	EU	CODE	PACK	DLR €	10%	SEASONAL ORDER 20%	RRP €
LIGHT WHITE	31/32	DP183031	3	18,13	16,32	14,50	29,99
LIGHT WHITE	33/34	DP183033	3	18,13	16,32	14,50	29,99
LIGHT BLUE	31/32	DP182031	3	18,13	16,32	14,50	29,99
LIGHT BLUE	33/34	DP182033	3	18,13	16,32	14,50	29,99
ADULT SIZE	EU	CODE	PACK	DLR €	10%	SEASONAL ORDER 20%	RRP €
LIGHT WHITE	35/36	DP183035	3	18,13	16,32	14,50	29,99
LIGHT WHITE	37/38	DP183037	3	18,13	16,32	14,50	29,99
LIGHT WHITE	39/40	DP183039	3	18,13	16,32	14,50	29,99
LIGHT WHITE	41/42	DP183041	3	18,13	16,32	14,50	29,99
LIGHT WHITE	43/44	DP183043	3	18,13	16,32	14,50	29,99
LIGHT WHITE	45/46	DP183045	3	18,13	16,32	14,50	29,99
LIGHT BLUE	35/36	DP182035	3	18,13	16,32	14,50	29,99
LIGHT BLUE	37/38	DP182037	3	18,13	16,32	14,50	29,99
LIGHT BLUE	39/40	DP182039	3	18,13	16,32	14,50	29,99
LIGHT BLUE	41/42	DP182041	3	18,13	16,32	14,50	29,99
LIGHT BLUE	43/44	DP182043	3	18,13	16,32	14,50	29,99
LIGHT BLUE	45/46	DP182045	3	18,13	16,32	14,50	29,99



BLUE



WHITE





# MINI LIGHT

## KIDS SWIMMING FINS

Fin as a shoe with short blade 100% natural rubber. This material has a great resistance to breakage and abrasion damage that makes it suitable for use by children both at sea and in the pool. The fin is designed with the shoe in the middle of the blade, so that the transmission of force is effective, with a progressive motion and pleasant for the swimmer, reducing the hydrodynamic resistance of the upper part of the foot.

The sole has a calculated rigidity to avoid cramping at the sole of the foot. The rear part of the shoe is thicker, reinforced and has a tongue that facilitates its positioning. All the edges in contact with the skin are rounded for greater comfort. The very soft and comfortable elastomer (thermoplastic rubber), which surrounds the upper part of the shoe and the side spars, helps the stability of the fin during swimming.



SOFT ULTRA FLEXIBLE MATERIAL



AZURE



YELLOW

KID SIZE	EU	CODE	PACK	DLR €	10%	SEASONAL ORDER 20%	RRP €
MINI LIGHT AZURE	23/24	DP302123	6	21,24	19,12	16,99	34,99
MINI LIGHT AZURE	25/28	DP302125	6	21,24	19,12	16,99	34,99
MINI LIGHT AZURE	29/31	DP302129	6	21,24	19,12	16,99	34,99
MINI LIGHT AZURE	32/33	DP302132	6	21,24	19,12	16,99	34,99
MINI LIGHT AZURE	34/35	DP302134	6	21,24	19,12	16,99	34,99
MINI LIGHT YELLOW	23/24	DP301023	6	21,24	19,12	16,99	34,99
MINI LIGHT YELLOW	25/28	DP301025	6	21,24	19,12	16,99	34,99
MINI LIGHT YELLOW	29/31	DP301029	6	21,24	19,12	16,99	34,99
MINI LIGHT YELLOW	32/33	DP301032	6	21,24	19,12	16,99	34,99
MINI LIGHT YELLOW	34/35	DP301034	6	21,24	19,12	16,99	34,99



# ROCKS

## KIDS SNORKELING FINS

The Rocks are a composite-design, vented open heel fins with adjustable straps designed to follow the kid's growth. The straps have the large-thumb-loop for easy donning and doffing. Dual composite vented blades provide excellent power and energy saving efficiency. All in all, these fins are great for family snorkel trips and will allow hours of underwater exploration.



### TECHNICAL FEATURES

- Foot pocket made of comfortable rubber
- Large thumb loop
- Push-button buckles to easily adjust strap length
- Blade designed to reduce leg cramps

PRODUCT	SIZE	CODE	PACK	DLR €	10%	SEASONAL ORDER 20%	RRP €
ROCKS KID FINS PINK/WHITE	L/XL	USF100041	6	18,13	16,32	14,50	29,99
ROCKS KID FINS PINK/WHITE	S/M	USF100040	6	18,13	16,32	14,50	29,99
ROCKS KID FINS WHITE/LIGHT BLUE	L/XL	USF100021	6	18,13	16,32	14,50	29,99
ROCKS KID FINS WHITE/LIGHT BLUE	S/M	USF100020	6	18,13	16,32	14,50	29,99



PINK/WHITE



WHITE/LIGHT BLUE









# SNORKEL SETS

# MAUI BAG NEW 2023

## MAUI FINS + FIJI MASK + GAMMA SNORKEL

PATENTED ANTI-FOG SYSTEM



### INNER MEMBRANES

A patented membrane surrounding the inner nose pocket and both the inner eyes pockets which acts as a barrier and traps any moisture escaping from the diver's nose involuntarily when breathing through the mouth. The result is that not only is the moisture channeled away from the lenses, thus avoiding the fogging up of them, but it also reduces the need to compensate for pressure.

### HEAT EXCHANGER

The external part of the skirt features a cooling system composed of two small heat exchangers that act as radiators. Thanks to this system, the temperature inside mask drops, coming closer to the external temperature and the droplets of humidity are trapped before the air reaches the lenses, preventing them from fogging up.

### NEW TEXTILE ELASTIC STRAP



PRODUCT	EU	CODE	PACK	DLR €	10%	SEASONAL ORDER 20%	RRP €
MAUI BAG SET BLACK/BLUE	S/M	CB165238	6	66.24	59.62	52.99	105.99
MAUI BAG SET BLACK/BLUE	M/L	CB165241	6	66.24	59.62	52.99	105.99
MAUI BAG SET BLACK/BLUE	L/XL	CB165244	6	66.24	59.62	52.99	105.99



# PRO STAR BAG

## PRO STAR FINS + MATRIX MASK + GAMMA SNORKEL



### TOTAL LENGTH

SIZE	CM	IN
37/38 (4/5)	60	23.64
39/40 (5.5/6.5)	62.5	24.63
41/42 (7/8)	64.5	25.41
43/44 (8.5/9.5)	66.5	26.2
45/46 (10/11)	68.5	26.99

### BLADE LENGTH

SIZE	CM	IN
37/38 (4/5)	50	19.7
39/40 (5.5/6.5)	50.5	19.9
41/42 (7/8)	52	20.49
43/44 (8.5/9.5)	54.5	21.47
45/46 (10/11)	56.5	22.26

### MAX WIDTH

SIZE	CM	IN
37/38 (4/5)	20	7.88
39/40 (5.5/6.5)	20.5	8.08
41/42 (7/8)	21	8.27
43/44 (8.5/9.5)	21.5	8.47
45/46 (10/11)	22	8.67

### SINGLE FIN WEIGHT

SIZE	CM	IN
37/38 (4/5)	575	1.27
39/40 (5.5/6.5)	615	1.36
41/42 (7/8)	645	1.42
43/44 (8.5/9.5)	710	1.57
45/46 (10/11)	790	1.74

### NET BAG



PRODUCT	EU	CODE	PACK	DLR €	10%	SEASONAL ORDER 20%	RRP €
PRO STAR BAG SET BLACK	37/38	BG189537	6	58.74	52.87	46.99	99.99
PRO STAR BAG SET BLACK	39/40	BG189539	6	58.74	52.87	46.99	99.99
PRO STAR BAG SET BLACK	41/42	BG189541	6	58.74	52.87	46.99	99.99
PRO STAR BAG SET BLACK	43/44	BG189543	6	58.74	52.87	46.99	99.99
PRO STAR BAG SET BLACK	45/46	BG189545	6	58.74	52.87	46.99	99.99



/ SNORKEL SETS

# PLUMA BAG

PLUMA FINS + PERLA MASK + GAMMA SNORKEL



PRODUCT	EU	CODE	PACK	DLR €	10%	SEASONAL ORDER 20%	RRP €
PLUMA BAG SET BLACK	35/36	CA179535	6	44,99	40,49	35,99	74,99
PLUMA BAG SET BLACK	37/38	CA179537	6	44,99	40,49	35,99	74,99
PLUMA BAG SET BLACK	39/40	CA179539	6	44,99	40,49	35,99	74,99
PLUMA BAG SET BLACK	41/42	CA179541	6	44,99	40,49	35,99	74,99
PLUMA BAG SET BLACK	43/44	CA179543	6	44,99	40,49	35,99	74,99
PLUMA BAG SET BLACK	45/46	CA179545	6	44,99	40,49	35,99	74,99



# AGUA BAG

AGUA FINS + ONDA MASK + MEXICO SNORKEL



PRODUCT	EU	CODE	PACK	DLR €	10%	SEASONAL ORDER 20%	RRP €
SET AGUA + ONDA + MEXICO BLUE	35/36	XCA312035	6	39,38	35,44	31,50	64,99
SET AGUA + ONDA + MEXICO BLUE	37/38	XCA312037	6	39,38	35,44	31,50	64,99
SET AGUA + ONDA + MEXICO BLUE	39/40	XCA312039	6	39,38	35,44	31,50	64,99
SET AGUA + ONDA + MEXICO BLUE	41/42	XCA312041	6	39,38	35,44	31,50	64,99
SET AGUA + ONDA + MEXICO BLUE	43/44	XCA312043	6	39,38	35,44	31,50	64,99
SET AGUA + ONDA + MEXICO BLUE	45/46	XCA312045	6	39,38	35,44	31,50	64,99



# RONDINELLA BAG

RONDINELLA FINS + ONDA MASK + GRINGO SNORKEL



PRODUCT	EU	CODE	PACK	DLR €	10%	SEASONAL ORDER 20%	RRP €
RONDINELLA BAG SET AQUAMARINE	35/36	CA189235	6	34,99	31,49	27,99	55,99
RONDINELLA BAG SET AQUAMARINE	37/38	CA189237	6	34,99	31,49	27,99	55,99
RONDINELLA BAG SET AQUAMARINE	39/40	CA189239	6	34,99	31,49	27,99	55,99
RONDINELLA BAG SET AQUAMARINE	41/42	CA189241	6	34,99	31,49	27,99	55,99
RONDINELLA BAG SET AQUAMARINE	43/44	CA189243	6	34,99	31,49	27,99	55,99
RONDINELLA BAG SET AQUAMARINE	45/46	CA189245	6	34,99	31,49	27,99	55,99
RONDINELLA BAG SET AQUAMARINE	47/48	CA189247	6	34,99	31,49	27,99	55,99

# RONDINELLA BAG KID

RONDINELLA FINS + ONDINA MASK + MINIGRINGO SNORKEL



PRODUCT	EU	CODE	PACK	DLR €	10%	SEASONAL ORDER 20%	RRP €
RONDINELLA KID BAG SET AQUAMARINE	31/32	CA189231	6	34,99	31,49	27,99	55,99
RONDINELLA KID BAG SET AQUAMARINE	33/34	CA189233	6	34,99	31,49	27,99	55,99

# PALAU BAG

## PALAU FINS + MAREA MASK + GAMMA SNORKEL



BAG 30X60 CM

PRODUCT	SIZE	CODE	PACK	DLR €	10%	SEASONAL ORDER 20%	RRP €
PALAU MAREA BAG SET BLUE/AZURE	2XS/XS (32/35)	CA122632	6	49,99	44,99	39,99	89,99
PALAU MAREA BAG SET BLUE/AZURE	XS/S (35/38)	CA122635	6	49,99	44,99	39,99	89,99
PALAU MAREA BAG SET BLUE/AZURE	S/M (38/41)	CA122638	6	49,99	44,99	39,99	89,99
PALAU MAREA BAG SET BLUE/AZURE	M/L (41/44)	CA122641	6	49,99	44,99	39,99	89,99
PALAU MAREA BAG SET BLUE/AZURE	L/XL (44/47)	CA122644	6	49,99	44,99	39,99	89,99

# MINI PALAU BAG

## PALAU KID FINS + ESTRELLA JR MASK + TOP COLORAMA SNORKEL



PRODUCT	SIZE	CODE	PACK	DLR €	10%	SEASONAL ORDER 20%	RRP €
MINI PALAU BAG BLUE	29/32	CA123029	6	44,99	40,49	35,99	69,99
MINI PALAU BAG BLUE	32/35	CA123032	6	44,99	40,49	35,99	69,99
MINI PALAU BAG CLEAR PINK	29/32	CA123129	6	44,99	40,49	35,99	69,99
MINI PALAU BAG CLEAR PINK	32/35	CA123132	6	44,99	40,49	35,99	69,99



## FINS SPARE PARTS



EBS STRAP FOR:	SIZE	CODE	PACK	DLR €	10%	SEASONAL ORDER 20%	RRP €
THOR - ARA - PRO LIGHT - FROG	SHORT	BZ150004	2	19,99	17,99	15,99	39,99
THOR - ARA - PRO LIGHT - FROG	REGULAR	BZ150005	2	19,99	17,99	15,99	39,99
THOR - ARA - PRO LIGHT - FROG	EXTENDED	BZ150006	2	19,99	17,99	15,99	39,99
REACTION - FROG PLUS	SHORT	BZ150001	2	19,99	17,99	15,99	39,99
REACTION - FROG PLUS	REGULAR	BZ150002	2	19,99	17,99	15,99	39,99
REACTION - FROG PLUS	EXTENDED	BZ150003	2	19,99	17,99	15,99	39,99
MAUI GREY	-	CZ145550	2	16,24	14,62	12,99	25,99
MAUI BLACK	-	CZ145500	2	16,24	14,62	12,99	25,99
MAUI RED	-	CZ145800	2	16,24	14,62	12,99	25,99
MAUI BLUE	-	CZ145200	2	16,24	14,62	12,99	25,99

STRAP FOR:	CODE	PACK	DLR €	10%	SEASONAL ORDER 20%	RRP €
ALL FINS (EXCEPT PALAU - PALAU SAF)	BZ170002	1	6,24	5,62	4,99	9,99
PALAU - PALAU SAF	BZ170003	1	4,99	4,49	3,99	7,99

BUCKLES FOR:	CODE	PACK	DLR €	10%	SEASONAL ORDER 20%	RRP €
REACTION - FROG PLUS	BZ170016	2	11,88	10,69	9,50	18,99
THOR - ARA - PRO LIGHT	BZ170015	2	11,88	10,69	9,50	18,99
PALAU - PALAU SAF	BZ170004	2	5,63	5,07	4,50	8,99

## FINS BAGS

NET BAG 25X65 CM



CODE	DLR €	10%	SEASONAL ORDER 20%	RRP €
BZ175003	3,74	3,37	2,99	6,99

BAG 32X70 CM



CODE	DLR €	10%	SEASONAL ORDER 20%	RRP €
BZ175007	7,49	6,74	5,99	12,99

BAG 30X60 CM



CODE	DLR €	10%	SEASONAL ORDER 20%	RRP €
BZ175017	11,88	10,69	9,50	19,99

KID BAG BLUE



CODE	DLR €	10%	SEASONAL ORDER 20%	RRP €
BZ175030	8,74	7,87	6,99	14,99

KID BAG PINK



CODE	DLR €	10%	SEASONAL ORDER 20%	RRP €
BZ175031	8,74	7,87	6,99	14,99



# MASKS



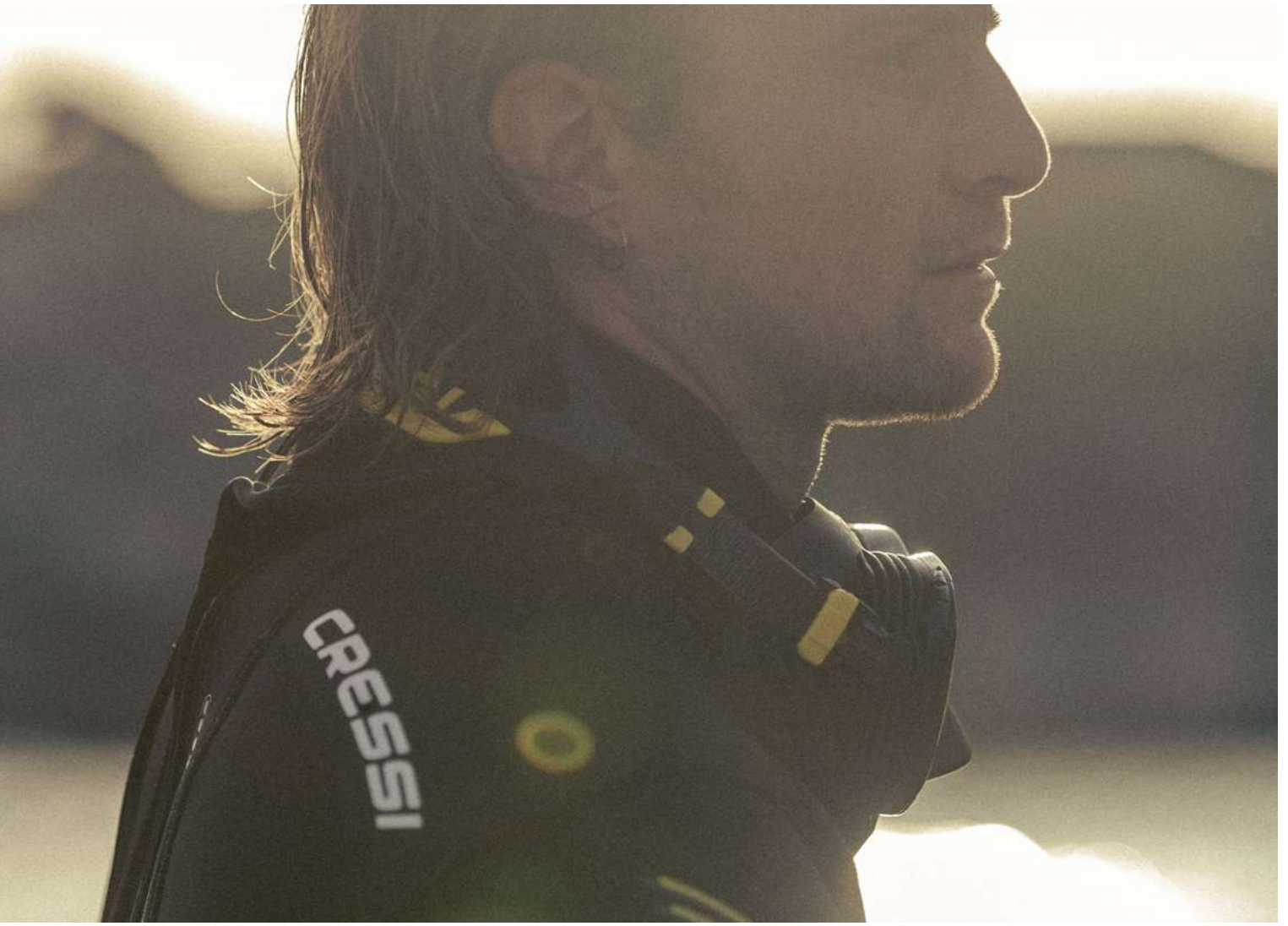



# QUANTUM



**SPECIALIZED**  
Retailer-Product

**NEW COLOR 2023**

## NEW REVOLUTIONARY ANTI-FOG SYSTEM

The major innovation with the Quantum mask is that as well as offering enhanced downwards vision it avoids the fogging phenomenon through the internal thermoregulation of the warm, damp air exiting the nose. This air is channelled by a system of membranes set in the moulding around the eyes and nose and deviating the flow towards the rubber skirt rather than the lenses.

The external part of the skirt features a cooling system composed of two small heat exchangers that act as radiators. The effect is that the temperature inside mask drops, coming closer to the external temperature and the droplets of humidity are trapped before the air reaches the lenses, preventing them from fogging up. Despite the presence of the small internal

membranes deviating the air flow and the external heat exchangers, the body of the Quantum mask is nonetheless compact and represents the most advanced design offered on the underwater vision market.

The lenses are not treated chemically and it should be remembered that when the mask is new, as is the case with all masks, we advise you to clean the

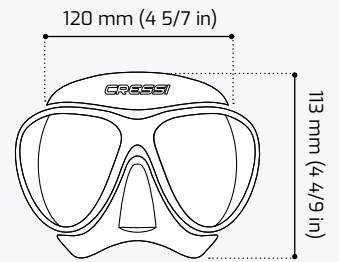

BLACK **HD IRIDIUM LENSES**



BLACK **HD MIRRORRED LENSES**



BLACK/BLACK



BLACK/RED



BLACK/BLUE



BLACK/YELLOW



BLUE METAL



CLEAR/BLACK

PATENTED ANTI-FOG SYSTEM

DOUBLE INJECTION TECHNOLOGY

INCLINED LENSES

FLEXIBLE BUCKLE WITH MICROMETRIC ADJUSTMENT

BI-SILICONE STRAP

TEMPERED GLASS

100% HIGH QUALITY SILICONE SKIRT

lenses carefully with toothpaste or dishwashing detergent, or simply use Cressi Antifog to clean away all volatile materials and dust that may have collected on the glass. It is also always useful to use saliva as a surfactant before every dive.



DOUBLE INJECTION SILICONE STRAP

**OPTICAL LENSES**

Possibility of mounting optical lenses  
CORRECTION +1.0 > +3.0 / -1.00 > -6.00



Asymmetrical Bifocal Positive lenses

**INNER MEMBRANES + HEAT EXCHANGER**



**INNER MEMBRANES**

A patented membrane surrounding the inner nose pocket (1) and both the inner eyes pockets (2) which acts as a barrier and traps any moisture escaping from the diver's nose involuntarily when breathing through the mouth. The result is that not only is the moisture channeled away from the lenses, thus avoiding the fogging up of them, but it also reduces the need to compensate for pressure.

To further improve the anti-fog effect, Cressi suggests, the first times that the dive mask is used, to spray some anti-fog solution or to apply some saliva on the inside of the lenses and then to rinse them with water.

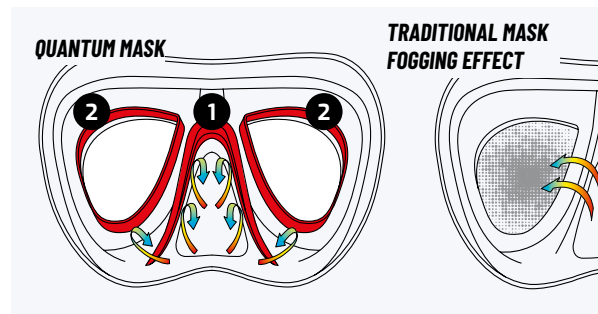

**HEAT EXCHANGER**

The external part of the skirt features a cooling system composed of two small heat exchangers that act as radiators (3). Thanks to this system, the temperature inside mask drops, coming closer to the external temperature and the droplets of humidity are trapped before the air reaches the lenses, preventing them from fogging up.



CLEAR/BLUE

CLEAR/PINK

PRODUCT	PACK	CODE	DLR €	10%	SEASONAL ORDER 20%	RRP €
QUANTUM MASK BLACK/BLACK	6	DS515050	52,49	47,24	41,99	89,99
QUANTUM MASK BLACK/RED	6	DS515080	52,49	47,24	41,99	89,99
QUANTUM MASK BLACK/BLUE	6	DS515020	52,49	47,24	41,99	89,99
QUANTUM MASK BLACK/YELLOW	6	DS515010	52,49	47,24	41,99	89,99
QUANTUM MASK BLUE METAL	6	DS512020	52,49	47,24	41,99	89,99
QUANTUM MASK CLEAR/BLACK	6	DS510050	52,49	47,24	41,99	89,99
QUANTUM MASK CLEAR/BLUE	6	DS510020	52,49	47,24	41,99	89,99
QUANTUM MASK CLEAR/PINK	6	DS510040	52,49	47,24	41,99	89,99
QUANTUM MASK BLACK/BLACK IRIDIUM LENS	6	DS5150509	62,49	56,24	49,99	99,99
QUANTUM MASK BLACK/BLACK MIRROR LENS	6	DS5150508	62,49	56,24	49,99	99,99

**ZEUS**  **ATELIER**  
offline product

- U.S. PAT  
6272693 B1
- DOUBLE INJECTION  
TECHNOLOGY
- IDF-TECHNOLOGY  
INTEGRATED DUAL FRAME
- INCLINED  
LENSES
- FLEXIBLE  
BUCKLE
- TEMPERED  
GLASS
- 100% HIGH QUALITY  
SILICONE SKIRT

**FOG STOP SYSTEM**

Zeus is the perfect mask for diving. This mask has a particular tapered structure deriving directly from the highly popular Nano-mask patent. The same IDF-INTEGRATED DUAL FRAME TECHNOLOGY SYSTEM allows you to join the silicone skirt to the lens frame without major interruptions of the

curvature continuity. The result is a mask with an extremely hydrodynamic shape and, visibility being equal, a significantly smaller size. The field of view obtained is particularly wide, laterally and in the lower zone. Thanks to its matte coating the mask's components all match, enhancing the underwater

experience since it prevents reflections in the water that may disturb marine life. The new micrometric adjustable buckles with a larger button allow a more easily regulation also wearing dive gloves. The new strap is made of two different silicone colors.



**IRIDIUM LENSES**  
OPTICAL GLASS UV 420  
PROTECTION FILTER



PRODUCT	PACK	CODE	DLR €	10%	SEASONAL ORDER 20%	RRP €
ZEUS MASK LENS IRIDIUM BLACK/FRAME BLACK	6	DS4750509	62.49	56.24	49.99	99.99
ZEUS MASK DARK/GOLD	6	DS475009	48.74	43.87	38.99	79.99
ZEUS MASK BLUE METAL	6	DS475550	48.74	43.87	38.99	79.99
ZEUS MASK BLACK/FRAME BLACK	6	DS475050	48.74	43.87	38.99	79.99
ZEUS MASK GREY	6	DS475150	48.74	43.87	38.99	79.99
ZEUS MASK BLACK/FRAME RED	6	DS475058	48.74	43.87	38.99	79.99
ZEUS MASK BLACK/FRAME SILVER	6	DS475051	48.74	43.87	38.99	79.99
ZEUS MASK CLEAR BLUE METAL	6	DS470020	48.74	43.87	38.99	79.99
ZEUS MASK CLEAR PINK	6	DS470040	48.74	43.87	38.99	79.99
ZEUS MASK CLEAR BLACK	6	DS470050	48.74	43.87	38.99	79.99

**FOG STOP SYSTEM**

**INNER NOSE POCKET - NEW PATENT PENDING**

A patented membrane surrounding the inner nose pocket which acts as a barrier and traps any moisture escaping from the diver's nose involuntarily when breathing through the mouth. The result is that not only is the moisture channeled away from the lenses, thus avoiding the fogging up of them, but it also reduces the need to compensate for pressure.

To further improve the anti-fog effect, Cressi suggests, the first times that the dive mask is used, to spray some anti-fog solution or to apply some saliva on the inside of the lenses and then to rinse them with water.

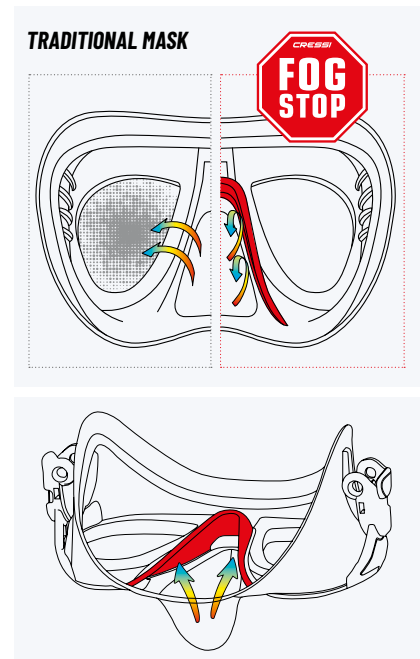

**DOUBLE INJECTION SILICONE STRAP**





**SF1**  **SPECIALIZED**  
Retailer-Product

FRAMELESS TECHNOLOGY CRESSI

MICROMETRIC ADJUSTABLE BUCKLE

TEMPERED GLASS

HIGH QUALITY HYPOALLERGENIC SILICONE

SOFT NOSE POCKET

100% HIGH QUALITY SILICONE SKIRT

## SQUARED FRAMELESS DIVE MASK

This frameless single glass mask is made of trendy shiny silicone and has a very small internal volume. Rigorous and squared design suitable even for demanding divers.

Fits most face shapes. Buckle with micrometric adjustment system. Supplied in a sturdy protective box.

### TECHNICAL FEATURES

- Ultra low-volume, single lens design for excellent field-of-view
- Silicone skirt bonds directly to the lens for lower weight and reduced drag
- Quickly adjustable buckles mounted on the skirt
- High-quality flexible silicone that gently and securely adheres to the face



PRODUCT	PACK	CODE	DLR €	10%	SEASONAL ORDER 20%	RRP €
SF1 MASK SIL CLEAR	6	ZDN331000	49.99	44.99	39.99	79.99
SF1 MASK SIL BLUE	6	ZDN331020	49.99	44.99	39.99	79.99
SF1 MASK SIL SILVER	6	ZDN331051	49.99	44.99	39.99	79.99
SF1 MASK SIL BLACK	6	ZDN332000	49.99	44.99	39.99	79.99

**Z1** **SPECIALIZED**  
Retailer-Product

FRAMELESS TECHNOLOGY CRESSI

MICROMETRIC ADJUSTABLE BUCKLE

TEMPERED GLASS

100% HIGH QUALITY SILICONE SKIRT

# LOW VOLUME FRAMELESS MASK

Z1 is a frameless mask that boasts a low internal volume while offering a wide field of view in all directions. The specific design uses the assembly of the silicone skirt directly over the single glass. This system guarantees great sturdiness and a perfect watertight seal.

The lower weight of the mask makes it ideal for travel. The flexible fit and reduced drag are appreciated for freediving and spearfishing, snorkeling and diving. The micrometrically adjustable buckles are comfortable and effective.

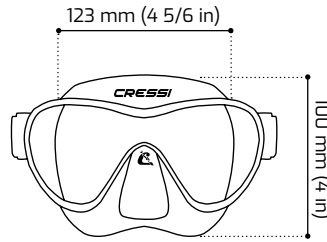

### TECHNICAL FEATURES

- Low-volume, single lens design for a wide field-of-view
- Frameless: silicone skirt bonds directly to the lens for lower weight and reduced drag
- Fast-adjust ratcheting strap buckles mounted to skirt
- High-grade silicone seals
- Tempered glass lens
- Easy-access nose pocket for equalization



PRODUCT	PACK	CODE	DLR €	10%	SEASONAL ORDER 20%	RRP €
Z1 MASK SIL CLEAR/FRAME CLEAR	6	DN410000	44,99	40,49	35,99	74,99
Z1 MASK SIL BLUE/FRAME BLUE	6	DN410020	44,99	40,49	35,99	74,99
Z1 MASK SIL GRAPHITE/FRAME GRAPHITE	6	DN410057	44,99	40,49	35,99	74,99
Z1 MASK SIL BLACK/FRAME BLACK	6	DN410050	44,99	40,49	35,99	74,99
Z1 MASK SIL RED/FRAME RED	6	DN410080	44,99	40,49	35,99	74,99

**ZS1**  **SPECIALIZED**  
Retailer-Product

FOR ADULTS WITH  
A SMALL FACE

FRAMELESS  
TECHNOLOGY CRESSI

MICROMETRIC  
ADJUSTABLE BUCKLE

TEMPERED  
GLASS

100% HIGH QUALITY  
SILICONE SKIRT

**SMALLER VERSION OF Z1 MASK**

ZS1 is the Small version, suitable for adults with small faces, of the Z1, a frameless mask that boasts a low internal volume while offering a wide field of view in all directions. The specific design uses the assembly of the silicone skirt directly over the single glass. This system guarantees great sturdiness and a perfect watertight seal.

The lower weight of the mask makes it ideal for travel. The flexible fit and reduced drag are appreciated for freediving and spearfishing, snorkeling and diving. The micrometrically adjustable buckles are comfortable and effective.

**TECHNICAL FEATURES**

- Low-volume, single lens design for a wide field-of-view
- Frameless: silicone skirt bonds directly to the lens for lower weight and reduced drag
- Fast-adjust ratcheting strap buckles mounted to skirt
- High-grade silicone seals
- Tempered glass lens
- Easy-access nose pocket for equalization

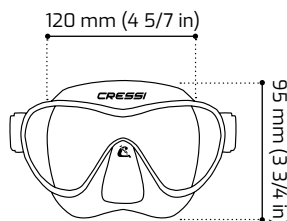

WHITE



KHAKI



BLACK



PINK FLUO



TURQUOISE



PRODUCT	PACK	CODE	DLR €	10%	SEASONAL ORDER 20%	RRP €
ZS1 MASK WHITE/WHITE	6	DN423030	44,99	40,49	35,99	74,99
ZS1 MASK KHAKI/KHAKI	6	DN428686	44,99	40,49	35,99	74,99
ZS1 MASK BLACK/BLACK	6	DN425050	44,99	40,49	35,99	74,99
ZS1 MASK PINK FLUO/PINK FLUO	6	DN424545	44,99	40,49	35,99	74,99
ZS1 MASK TURQUOISE/TURQUOISE	6	DN422828	44,99	40,49	35,99	74,99





# PENTA+ NEW 2023

LOW INTERNAL VOLUME

U.S. PAT 6272693 B1

DOUBLE INJECTION TECHNOLOGY

TEMPERED GLASS

FLEXIBLE BUCKLE

INCLINED LENSES

100% HIGH QUALITY SILICONE SKIRT

## UNPRECEDENTED TOTAL VISION

The Penta+ is the restyling of the popular Penta mask. It has four lenses and also introduces to this sector all the exceptional characteristics of the Matrix and the Lince. The Cressi patented system of raked lenses with an "inverted drop" shape offers incredible downward visibility, ideal for having under control the scuba diving equipment. The

clear side windows are made of scratch-resistant material, more strong than glass or polycarbonate. Thanks to them, the mask offers unprecedented lateral visibility and great luminosity for total vision with no compromises. The skirt and the strap are made of hypoallergenic silicone, a very soft material compared to the low-quality PVC,

that ensures a perfect seal and comfort. The buckles are embedded in the frame to offer instant adjustment of the strap length, even with one hand. It offers a very low internal volume, a record weight of only 175 g (6.2 oz).

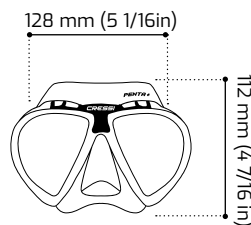

### TECHNICAL FEATURES

- Type: four lens mask
- Front lenses: inverted teardrop design to ensure maximum visibility, made of tempered glass
- Strap buckles: pressure, with instant adjustment
- Very low internal volume
- Weight: 175 g (6.2 oz)



BLACK/BLUE

BLACK/BLACK

CLEAR/BLUE

CLEAR/PINK

PRODUCT	PACK	CODE	DLR €	10%	SEASONAL ORDER 20%	RRP €
PENTA+ MASK BLACK/BLUE	6	DS495020	46.24	41.62	36.99	69.99
PENTA+ MASK BLACK/BLACK	6	DS495050	46.24	41.62	36.99	69.99
PENTA + MASK CLEAR/BLUE	6	DS490020	46.24	41.62	36.99	69.99
PENTA+ MASK CLEAR/PINK	6	DS490040	46.24	41.62	36.99	69.99



# AIR

U.S. PAT  
6272693 B1

DOUBLE INJECTION  
TECHNOLOGY

IDF-TECHNOLOGY  
INTEGRATED DUAL FRAME

TEMPERED  
GLASS

MICROMETRIC  
ADJUSTABLE BUCKLE

FLEXIBLE  
BUCKLE

INCLINED  
LENSES

100% HIGH QUALITY  
SILICONE SKIRT

## NEW IDF TECHNOLOGY INTEGRATED DUAL FRAME

This mask has a particular tapered structure deriving directly from the highly popular Nano-mask patent. THE DUAL INTEGRATED FRAME TECHNOLOGY SYSTEM allows you to join the silicone skirt to the lens frame without major interruptions of the curvature continuity.

The result is a mask with an extremely hydrodynamic shape and, visibility being equal, a significantly smaller size. The field of view obtained is particularly wide, laterally and in the lower zone. The skirt, in the front part, has a structural silicone insert which increases the sealing ability

of the mask and creates an exceptionally pleasant chromatic play. Micrometer adjustable buckles.



CLEAR ASSORTED



CLEAR/BLACK/YELLOW



CLEAR/BLACK/BLUE



BLUE METAL



BLACK/BLACK/YELLOW



BLACK/BLACK



BLACK/BLACK/BLUE



PRODUCT	PACK	CODE	DLR €	10%	SEASONAL ORDER 20%	RRP €
AIR MASK SIL CLEAR ASSORTED	12	DS400099	46.24	41.62	36.99	69.99
AIR MASK SIL CLEAR/FRAME BLACK YELLOW	6	DS400010	46.24	41.62	36.99	69.99
AIR MASK SIL CLEAR/FRAME BLACK BLUE	6	DS400062	46.24	41.62	36.99	69.99
AIR MASK SIL BLUE METAL	6	DS405550	46.24	41.62	36.99	69.99
AIR MASK SIL BLACKL/FRAME BLACK YELLOW	6	DS405010	46.24	41.62	36.99	69.99
AIR MASK SIL BLACKL/FRAME BLACK	6	DS405050	46.24	41.62	36.99	69.99
AIR MASK SIL BLACKL/FRAME BLACK BLUE	6	DS405062	46.24	41.62	36.99	69.99



LOW INNER VOLUME MASK



MADE IN ITALY

# ATOM SPECIALIZED

Retailer-Product

NEW 2023

- FLEXIBLE BUCKLE
- MICROMETRIC ADJUSTABLE BUCKLE
- TEMPERED GLASS
- 100% HIGH QUALITY SILICONE SKIRT
- ULTRA LOW VOLUME
- ERGONOMIC NOSE SHAPE
- EASY COMPENSATION

## ULTRA LOW VOLUME MASK

Atom is a radical mask, with incredible low internal volume, thought and built for free-diving. It is a frameless mask. Construction material has been reduced to the minimum. Inside the silicon facial a stiff core is co-stamped with the two lenses, giving just the right rigidity to the mask. This semi-rigid core substitutes the usual external plastic frame and allowed us to reduce the internal volume of the mask in an unseen way until today.

Another feature of Atom is the ergonomic shape of the nose. Two small cavities, carved by the nostrils, facilitate the action of compensation. This makes the mask extremely stable during the dive. Atom will not move when you compensate pushing. Atom is the perfect mask for the expert free-diver and spear-fisher, who wants the maximum performance from its gear.



### TECHNICAL FEATURES

- Ultra low-volume mask, designed for facilitate the action of compensation
- Rigid co-stamped stiff core
- Ergonomic shape of the nose, design for facilitate the action of compensation
- Ideal for expert free-diver and spear-fisher



PRODUCT	PACK	CODE	DLR €	10%	SEASONAL ORDER 20%	RRP €
ATOM MASK BLUE METAL/BLACK	6	D5522050	43.74	39.37	34.99	69.99
ATOM MASK WHITE/BLACK	6	D5523050	43.74	39.37	34.99	69.99
ATOM MASK BLACK/BLACK	6	D5525050	43.74	39.37	34.99	69.99
ATOM MASK MIRRORED LENS BLACK/BLACK	6	D5525051	43.74	39.37	34.99	69.99
ATOM MASK GREEN/BLACK	6	D5527550	43.74	39.37	34.99	69.99



# CALIBRO

## FOG STOP SYSTEM

U.S. PAT  
6272693 B1

MICROMETRIC  
ADJUSTABLE BUCKLE

IDF-TECHNOLOGY  
INTEGRATED DUAL FRAME

ULTRA LOW  
VOLUME

FLEXIBLE  
BUCKLE

TEMPERED  
GLASS

100% HIGH QUALITY  
SILICONE SKIRT

Cressi's next generation diving masks are all equipped with the IDF-INTEGRATED DUAL FRAME TECHNOLOGY which offers exceptional field of view, and the new Calibro is no exception. The mask is designed so that the integrated face and frame allow for an extremely hydrodynamic and compact shape and a particularly wide lens, maintaining the mask extremely close to the face. Cressi's Calibro combines minimal internal volume with a phenomenal field of view due to the raked angle of the frame. The buckles are, as always,

directly integrated into the rigid skirt through a solid but flexible rubber attachment that allows you to adjust and place the mouthpiece without shifting the mask. Thanks to its matte coating the mask's components all match, enhancing the underwater experience since it prevents reflections in the water that may disturb marine life. Calibro is the perfect mask also for free-diving since it is designed to provide the diver with a feeling of total freedom and comfort.



HD MIRRORED LENSES

PRODUCT	PACK	CODE	DLR €	10%	SEASONAL ORDER 20%	RRP €
CALIBRO MASK SIL CLEAR	6	D5426000	37,49	33,74	29,99	59,99
CALIBRO MASK SIL BLUE METAL	6	D5425550	37,49	33,74	29,99	59,99
CALIBRO MASK SIL WHITE/FRAME PINK	6	D5424030	37,49	33,74	29,99	59,99
CALIBRO MASK SIL BLACK/FRAME BLACK	6	D5425050	37,49	33,74	29,99	59,99
CALIBRO MASK SIL GREEN/FRAME GREEN	6	D5429850	37,49	33,74	29,99	59,99
CALIBRO MASK SIL BLACK/FRAME BLACK LENS HD	6	D5426050	49,99	44,99	39,99	79,99

### FOG STOP SYSTEM

#### INNER NOSE POCKET - NEW PATENT PENDING

A patented membrane surrounding the inner nose pocket which acts as a barrier and traps any moisture escaping from the diver's nose involuntarily when breathing through the mouth. The result is that not only is the moisture channeled away from the lenses, thus avoiding the fogging up of them, but it also reduces the need to compensate for pressure.

To further improve the anti-fog effect, Cressi suggests, the first times that the dive mask is used, to spray some anti-fog solution or to apply some saliva on the inside of the lenses and then to rinse them with water.

#### TRADITIONAL MASK

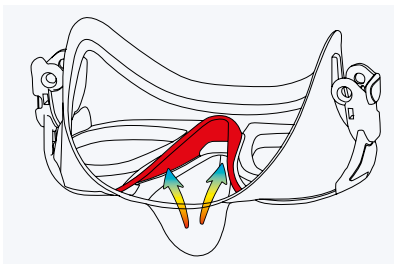
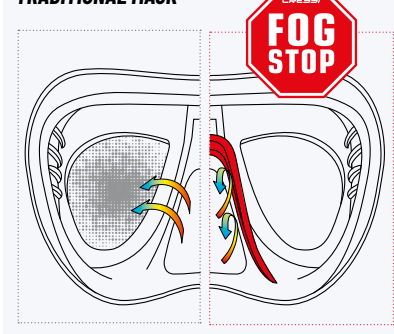

# NANO

## NEW IDF TECHNOLOGY INTEGRATED DUAL FRAME

Mask for advanced freediving and spearfishing, designed to offer an extremely hydrodynamic and compact shape to help divers cut through the water and aid movements in small spaces.

The internal volume is minimal and does not require intentional equalizing. The swiveling buckles feature micrometric regulation. Angled tempered glass lenses. Anatomical strap.

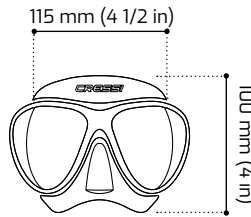

crystal®



PRODUCT	PACK	CODE	DLR €	10%	SEASONAL ORDER 20%	RRP €
NANO MASK SIL CRYSTAL/FRAME BLUE	6	D5360020	43,74	39,37	34,99	69,99
NANO MASK SIL CRYSTAL/FRAME YELLOW	6	D5360010	43,74	39,37	34,99	69,99
NANO MASK SIL CRYSTAL/FRAME PINK	6	D5360040	43,74	39,37	34,99	69,99
NANO MASK SIL CRYSTAL/FRAME WHITE	6	D5360060	43,74	39,37	34,99	69,99
NANO MASK SIL BLACK/FRAME BLACK	6	D5365050	43,74	39,37	34,99	69,99
NANO MASK SIL GREEN/FRAMEGREEN	6	D5369850	43,74	39,37	34,99	69,99
NANO MASK BLUE (SILVER/FRAME BLACK)	6	D5365550	43,74	39,37	34,99	69,99
NANO MASK SIL BLACK/FRAME BLACK LEN HD	6	D5366050	56,24	50,62	44,99	99,99
NANO MASK ASSORTED	12	D5360099	43,74	39,37	34,99	69,99

### TECHNICAL FEATURES

- Extremely hydrodynamic and compact design
- Internal volume just 85 cm<sup>3</sup>
- Reduced lens-face distance
- Angle lenses and slender structure optimize visibility
- Swivel buckles with micrometric adjustment
- Lenses in tempered glass
- Anatomical strap

### THE SILICONE REVOLUTION

crystal®

CRYSTAL silicone® is an exclusive CRESSI material that revolutionizes swim mask skirt clarity.



# BIG EYES EVOLUTION CRYSTAL

## WITH CRYSTAL SILICONE SKIRT

The ultimate in comfort and performance, the Big Eyes Evolution Crystal combines the best of Cressi technologies.

Raked lenses, with Cressi's inverted tear-drop shape, are placed close to the eyes for an exceptional field of view, and the Crystal Silicone

skirt delivers excellent light transmission while resisting discoloration and fogging.

The Crystal Silicone skirt also seals gently against the skin with a very open angle that accommodates a wide range of facial shapes.

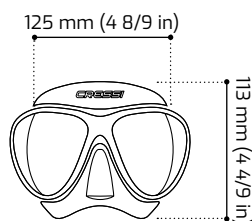

- TEMPERED GLASS
- U.S. PAT 6272693 B1
- DOUBLE INJECTION TECHNOLOGY
- INCLINED LENSES
- FLEXIBLE BUCKLE
- MICROMETRIC ADJUSTABLE BUCKLE
- 100% HIGH QUALITY SILICONE SKIRT

### TECHNICAL FEATURES

- Raked lenses provide excellent field-of-view
- Inverted tear-drop lenses improve downward visibility for managing BC-mounted gear
- Low internal volume allows for effortless clearing
- Crystal Silicone resists aging and prevents skirt discoloration and fogging
- Ribbed skirt design provides support where needed for a soft, flexible fit
- Micrometric adjustable buckles allow precise headband adjustments
- Swiveling buckles connect to flexible, indestructible elastomer tabs for total durability and comfort
- Accepts optical lenses

### OPTICAL LENSES

Possibility of mounting optical lenses  
CORRECTION +1.0 > +3.0 / -1.00 > -6.00



### THE SILICONE REVOLUTION

crystal<sup>®</sup>

CRYSTAL silicone<sup>®</sup> is an exclusive CRESSI material that revolutionizes swim mask skirt clarity.

It offers incredibly clear vision and features long-lasting advanced technology components within the pure silicone skirt which prevents premature discoloration, reduces fogging, and guarantees many years of CRYSTAL clear viewing.



CRYSTAL/YELLOW

CRYSTAL/BLUE/BLACK

CRYSTAL/PINK

crystal<sup>®</sup>



CRYSTAL/BLACK

CRYSTAL/BLUE

crystal<sup>®</sup>



PRODUCT	PACK	CODE	DLR €	10%	SEASONAL ORDER 20%	RRP €
BIG EYES EVOLUTION MASK SIL CRYSTAL/FRAME YELLOW	6	DS340010	43,74	39,37	34,99	74,99
BIG EYES EVOLUTION MASK SIL CRYSTAL/FRAME BLUE BLACK	6	DS340025	43,74	39,37	34,99	74,99
BIG EYES EVOLUTION MASK SIL CRYSTAL/FRAME PINK	6	DS340040	43,74	39,37	34,99	74,99
BIG EYES EVOLUTION MASK SIL CRYSTAL/FRAME BLACK	6	DS340060	43,74	39,37	34,99	74,99
BIG EYES EVOLUTION MASK SIL CRYSTAL/FRAME BLUE	6	DS340062	43,74	39,37	34,99	74,99



# BIG EYES EVOLUTION

## OUTSTANDING FIELD OF VIEW

The Big Eyes Evolution's signature inverted tear-drop lenses are raked inward and provide outstanding field of view with very low internal volume. A redesigned skirt now uses internal ribs

to provide the ultimate in fit and support. Fully flexible, easy adjust buckles are attached using Cressi's double injection molding technology for both comfort and extreme durability.

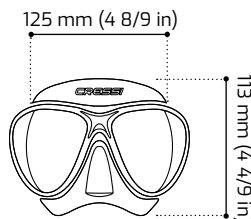

U.S. PAT  
6272693 B1

DOUBLE INJECTION  
TECHNOLOGY

TEMPERED  
GLASS

FLEXIBLE  
BUCKLE

MICROMETRIC  
ADJUSTABLE BUCKLE

INCLINED  
LENSES

100% HIGH QUALITY  
SILICONE SKIRT

### TECHNICAL FEATURES

- Raked lenses provide excellent field-of-view
- Inverted tear-drop lenses improve downward visibility for managing BC-mounted gear
- Low internal volume allows for effortless clearing
- Dual-density silicone skirt flexes for a perfect seal along the face and full support around the frame for a soft, flexible fit
- Ribbed facial skirt provides support where needed
- Micrometric adjustable buckles allow precise headband adjustments
- Swiveling buckles connect to flexible, indestructible elastomer tabs for total durability and comfort.
- Accepts optical lenses

### OPTICAL LENSES

Possibility of mounting optical lenses  
CORRECTION +1.0 > +3.0 / -1.00 > -6.00



Asymmetrical Bifocal Positive lenses



CLEAR/RED

CLEAR/YELLOW

CLEAR/BLUE/BLACK

CLEAR/PINK

CLEAR/BLACK

BLACK/BLACK

DARK BLUE

DARK YELLOW

BLACK/BLACK LENS HD

HD MIRRORED LENSES



PRODUCT	PACK	CODE	DLR €	10%	SEASONAL ORDER 20%	RRP €
BIG EYES EVOLUTION MASK SIL CLEAR/FRAME RED	6	D5336080	37,49	33,74	29,99	59,99
BIG EYES EVOLUTION MASK SIL CLEAR/FRAME YELLOW	6	D5336010	37,49	33,74	29,99	59,99
BIG EYES EVOLUTION MASK SIL CLEAR/FRAME BLUE BLACK	6	D5336020	37,49	33,74	29,99	59,99
BIG EYES EVOLUTION MASK SIL CLEAR/FRAME PINK	6	D5336040	37,49	33,74	29,99	59,99
BIG EYES EVOLUTION MASK SIL CLEAR/FRAME BLACK	6	D5336060	37,49	33,74	29,99	59,99
BIG EYES EVOLUTION MASK SIL BLACK/FRAME BLACK	6	D5336550	37,49	33,74	29,99	59,99
BIG EYES EVOLUTION MASK SIL DARK BLUE	6	D5336520	37,49	33,74	29,99	59,99
BIG EYES EVOLUTION MASK SIL DARK YELLOW	6	D5336510	37,49	33,74	29,99	59,99
BIG EYES EVOLUTION MASK SIL BLACK/FRAME BLACK LENS HD	6	D5336950	49,99	44,99	39,99	79,99



# EYES EVOLUTION CRYSTAL

## MEDIUM SIZE MASK WITH CRYSTAL SILICONE SKIRT

- INCLINED LENSES
- U.S. PAT 6272693 B1
- DOUBLE INJECTION TECHNOLOGY
- TEMPERED GLASS
- FLEXIBLE BUCKLE
- MICROMETRIC ADJUSTABLE BUCKLE
- 100% HIGH QUALITY SILICONE SKIRT



PRODUCT	CODE	DLR €	10%	SEASONAL ORDER 20%	RRP €
EYES EVOLUTION MASK SIL CRYSTAL/FRAME BLUE	DS350020	37.49	33.74	29.99	59.99
EYES EVOLUTION MASK SIL CRYSTAL/FRAME YELLOW	DS350010	37.49	33.74	29.99	59.99
EYES EVOLUTION MASK SIL CRYSTAL/FRAME PINK	DS350040	37.49	33.74	29.99	59.99
EYES EVOLUTION MASK SIL CRYSTAL/FRAME BLACK	DS350060	37.49	33.74	29.99	59.99

### TECHNICAL FEATURES

- Features the same great Cressi exclusive Crystal silicone as manufactured in the Big Eyes Evolution Crystal mask, but with styling and features in a medium size
- Designed for those with a narrow or small face



CRYSTAL/BLUE



CRYSTAL/YELLOW



CRYSTAL/PINK



CRYSTAL/BLACK

crystal®

# EYES EVOLUTION BLACK

## MEDIUM SIZE MASK



- U.S. PAT 6272693 B1
- DOUBLE INJECTION TECHNOLOGY
- TEMPERED GLASS
- FLEXIBLE BUCKLE
- MICROMETRIC ADJUSTABLE BUCKLE
- INCLINED LENSES



PRODUCT	PACK	CODE	DLR €	10%	SEASONAL ORDER 20%	RRP €
EYES EVOLUTION MASK SIL BLACK/FRAME BLACK	6	DS355050	37.49	33.74	29.99	59.99



# MATRIX

## EXCELLENT FIELD-OF-VIEW

The compact twin-lens Matrix takes the basic design concepts of the Big Eyes Evolution and pushes them to a new level of performance. More pronounced inverted tear-drop shaped lenses,

raked inward to sit even closer to the eyes, and a more compact build overall make the Matrix an ideal choice for divers and free divers looking for the biggest view in the smallest package.

U.S. PAT  
6272693 B1

INCLINED  
LENSES

MICROMETRIC  
ADJUSTABLE BUCKLE

TEMPERED  
GLASS

100% HIGH QUALITY  
SILICONE SKIRT

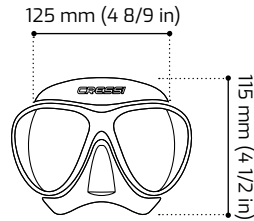

### TECHNICAL FEATURES

- Raked lenses provide excellent field-of-view
- Extremely low internal volume on par with the best free diving masks
- Silicone skirt shaped to provide a wide sealing surface for a leak-free fit
- Micrometric adjustable buckles allow precise headband adjustments
- Overmolded frame is easy to grip
- Inverted tear-drop lenses improve downward visibility for managing BC-mounted gear



 **DIVE CENTER**  
Product edition

PRODUCT	PACK	CODE	DLR €	10%	SEASONAL ORDER 20%	RRP €
MATRIX MASK SIL CLEAR/FRAME BLUE	6	D5301020	33.13	29.82	26.50	54.99
MATRIX MASK SIL CLEAR/FRAME YELLOW	6	D5301010	33.13	29.82	26.50	54.99
MATRIX MASK SIL CLEAR/FRAME BLACK	6	D5301060	33.13	29.82	26.50	54.99
MATRIX MASK SIL CLEAR/FRAME AQUAMARINE	6	D5301063	33.13	29.82	26.50	54.99
MATRIX MASK SIL BLACK/FRAME BLACK	6	D5302050	33.13	29.82	26.50	54.99
MATRIX MASK SIL GREEN/FRAME GREEN	6	D5309850	33.13	29.82	26.50	54.99
MATRIX MASK SIL BLACK/FRAME RED	6	JDS300058	33.13	29.82	26.50	54.99





# LINCE

## ULTRA COMPACT MASK

A trimmed down version of the Matrix, the Lince is a perfect fit for many younger divers or those with narrower faces. The extremely low internal volume makes it comfortable to wear and effortless to

clear. Divers and snorkelers alike will appreciate the exceptional field of view offered in this ultra compact mask.

U.S. PAT  
6272693 B1

INCLINED  
LENSES

MICROMETRIC  
ADJUSTABLE BUCKLE

TEMPERED  
GLASS

100% HIGH QUALITY  
SILICONE SKIRT

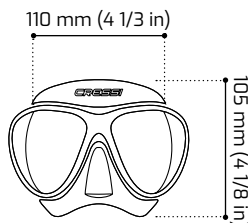

### TECHNICAL FEATURES

- Drastically reduced internal volume
- Instant-adjust pressure-strap buckles
- Skirt designed for women and children
- Excellent visibility and comfort
- For all underwater activities

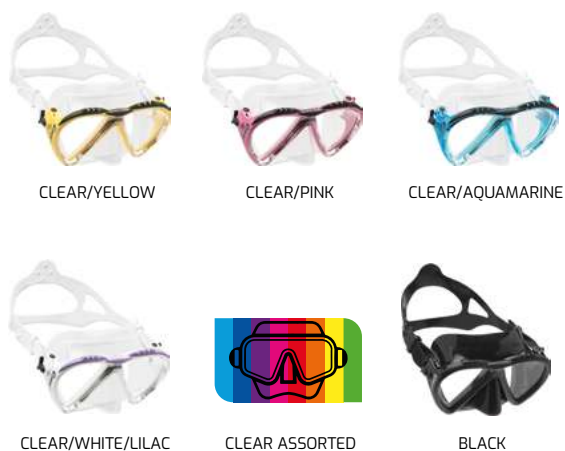

PRODUCT	PACK	CODE	DLR €	10%	SEASONAL ORDER 20%	RRP €
LINCE MASK SIL/FRAME ASSORTED	12	D5311099	33.13	29.82	26.5	54.99
LINCE MASK SIL CLEAR/FRAME YELLOW	6	D5311010	33.13	29.82	26.5	54.99
LINCE MASK SIL CLEAR/FRAME PINK	6	D5311040	33.13	29.82	26.5	54.99
LINCE MASK SIL CLEAR/FRAME AQUAMARINE	6	D5311063	33.13	29.82	26.5	54.99
LINCE MASK SIL CLEAR/FRAME WHITE/LILAC	6	D5311030	33.13	29.82	26.5	54.99
LINCE MASK SIL BLACK/FRAME BLACK	6	D5312050	33.13	29.82	26.5	54.99



# BIG EYES

## EXCELLENT FIELD-OF-VIEW

The mask that began a revolution remains one of the most duplicated designs today. Its inverted tear-drop lens shape and raked lenses provide 30% greater field of view than typical twin-

lens masks. The high-grade silicone skirt's unique shape positions the lenses comfortably close to the eyes and provides an excellent seal.

U.S. PAT  
6272693 B1

INCLINED  
LENSES

MICROMETRIC  
ADJUSTABLE BUCKLE

TEMPERED  
GLASS

100% HIGH QUALITY  
SILICONE SKIRT

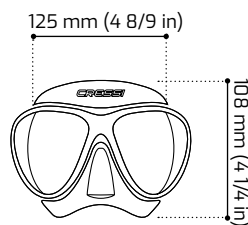

### TECHNICAL FEATURES

- Raked lenses provide excellent field-of-view
- Inverted tear-drop lenses improve downward visibility for managing BC-mounted gear
- Low internal volume allows for effortless clearing
- High-grade silicone skirt provides a leak-free seal
- Quick-adjust swivel buckles



CLEAR/BLACK



CLEAR/AZURE



CLEAR/BLUE INK



BLACK/BLUE



BLACK/BLACK

PRODUCT	PACK	CODE	DLR €	10%	SEASONAL ORDER 20%	RRP €
BIG EYES MASK SIL CLEAR/FRAME BLACK	6	D5261060	31.24	28.12	24.99	49.99
BIG EYES MASK SIL CLEAR/FRAME AZURE	6	D5261020	31.24	28.12	24.99	49.99
BIG EYES MASK SIL CLEAR/FRAME BLUE INK	6	D5261062	31.24	28.12	24.99	49.99
BIG EYES MASK SIL BLACK/FRAME BLUE	6	D5262020	31.24	28.12	24.99	49.99
BIG EYES MASK SIL BLACK/FRAME BLACK	6	D5262050	31.24	28.12	24.99	49.99



# FOCUS

## OPTICAL MASK

The ultimate in versatility, this classic mask offers the best fit and performance for the greatest variety of facial shapes. Its low-volume, twin-lens design gives divers and snorkelers a proven

combination of size, fit and durability. Lightweight and easy-to-clear it has swiveling, quick-adjust buckles and accepts corrective lenses. It is also an excellent value.

- EASY ADJUSTABLE BUCKLE
- TEMPERED GLASS
- 100% HIGH QUALITY SILICONE SKIRT



### TECHNICAL FEATURES

- Low internal volume allows for effortless clearing
- Lightweight, compact and rugged
- Ideal for travel or as a backup mask
- High-grade silicone skirt provides a leak-free seal
- Quick-adjust swivel buckles prevent binding
- Accepts optical lenses

### OPTICAL LENSES

Possibility of mounting optical lenses  
CORRECTION -1.0 > -8.00

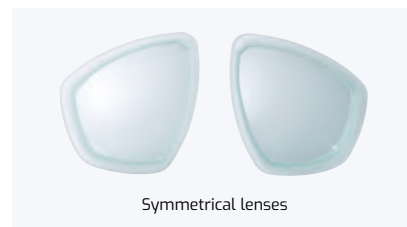

CLEAR ASSORTED



CLAER/PINK



CLAER/YELLOW



CLAER/BLUE



CLAER/BLACK



CLAER/AQUAMARINE



BLACK/BLUE



BLACK/BLACK



PRODUCT	PACK	CODE	DLR €	10%	SEASONAL ORDER 20%	RRP €
FOCUS MASK SIL CLEAR/FRAME ASSORTED	12	D5241099	31,24	28,12	24,99	49,99
FOCUS MASK SIL CLEAR/FRAME PINK	6	D5241040	31,24	28,12	24,99	49,99
FOCUS MASK SIL CLEAR/FRAME YELLOW	6	D5241010	31,24	28,12	24,99	49,99
FOCUS MASK SIL CLEAR/FRAME BLUE	6	D5241020	31,24	28,12	24,99	49,99
FOCUS MASK SIL CLEAR/FRAME BLACK	6	D5241060	31,24	28,12	24,99	49,99
FOCUS MASK SIL CLEAR/FRAME AQUAMARINE	6	D5241063	31,24	28,12	24,99	49,99
FOCUS MASK SIL BLACK/FRAME BLUE	6	D5242020	31,24	28,12	24,99	49,99
FOCUS MASK SIL BLACK/FRAME BLACK	6	D5242050	31,24	28,12	24,99	49,99





# F1

## FRAMELESS COLORAMA DIVE MASK

Frameless masks are loved by many divers for their low-profile and ability to fold flat for easy carrying, even in a BC pocket. Cressi's frameless design bonds a high-grade silicone skirt directly to a single lens for the ultimate in simplicity.

The low-internal volume allows for effortless clearing and quick-adjust strap buckles are molded directly into the skirt for a flexible fit and reduced drag. It also represents an unbeatable value, with a cost roughly half that of similar masks.

MICROMETRIC ADJUSTABLE BUCKLE | TEMPERED GLASS | 100% HIGH QUALITY SILICONE SKIRT

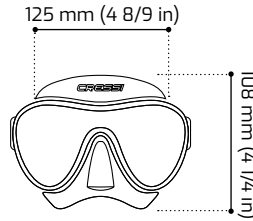

### TECHNICAL FEATURES

- Ultra low-volume, single lens design for excellent field-of-view
- Silicone skirt bonds directly to the lens for lower weight and reduced drag
- Fast-adjust ratcheting strap buckles mounted to skirt
- Supple, high-grade silicone seals gently and securely against the face
- Tempered glass lenses
- Easy-access nose pocket for equalization
- Excellent value



PRODUCT	PACK	CODE	DLR €	10%	SEASONAL ORDER 20%	RRP €
F1 MASK SIL BLACK	6	ZDN282000	32,49	29,24	25,99	51,99
F1 MASK SIL CLEAR	6	ZDN281000	32,49	29,24	25,99	51,99
F1 MASK SIL WHITE	6	ZDN283000	32,49	29,24	25,99	51,99
F1 MASK SIL YELLOW	6	ZDN281010	32,49	29,24	25,99	51,99
F1 MASK SIL BLUE	6	ZDN281020	32,49	29,24	25,99	51,99
F1 MASK SIL PINK	6	ZDN284000	32,49	29,24	25,99	51,99
F1 MASK SIL SILVER	6	ZDN281051	32,49	29,24	25,99	51,99
F1 MASK SIL LIME	6	WDN281067	32,49	29,24	25,99	51,99
F1 MASK SIL ORANGE	6	ZDN288000	32,49	29,24	25,99	51,99

# F1 SMALL

## SMALL FIT MASK

Frameless masks are loved by many divers for their low-profile and ability to fold flat for easy carrying, even in a BC pocket. Cressi's frameless design bonds a high-grade silicone skirt directly to a single lens for the ultimate in simplicity.

The low-internal volume allows for effortless clearing and quick-adjust strap buckles are molded directly into the skirt for a flexible fit and reduced drag. It also represents an unbeatable value, with a cost roughly half that of similar masks.

MICROMETRIC ADJUSTABLE BUCKLE | TEMPERED GLASS | 100% HIGH QUALITY SILICONE SKIRT

### TECHNICAL FEATURES

- Ultra low-volume, single lens design for excellent field-of-view
- Silicone skirt bonds directly to the lens for lower weight and reduced drag
- Fast-adjust ratcheting strap buckles mounted to skirt
- Supple, high-grade silicone seals gently and securely against the face
- Tempered glass lenses
- Easy-access nose pocket for equalization
- Excellent value

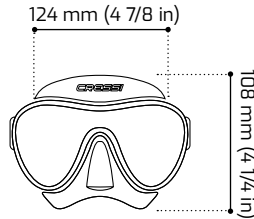

BLUE

PINK

BLACK

PRODUCT	PACK	CODE	DLR €	10%	SEASONAL ORDER 20%	RRP €
F1 SMALL MASK BLUE	6	ZDN311020	32,49	29,24	25,99	51,99
F1 SMALL MASK PINK	6	ZDN311040	32,49	29,24	25,99	51,99
F1 SMALL MASK BLACK	6	ZDN311050	32,49	29,24	25,99	51,99

# LIBERTY TRISIDE

## THREE WINDOWED MASK

The Liberty Triside features a wide mono front lens with 2-sided lenses to ensure a panoramic view without interruption. The result is a mask that allows maximum light and feels as open as the ocean itself. All lenses are tempered glass for the best clarity. The skirt is made in hypoallergenic silicone to

ensure comfort and a perfect seal. It is a breeze to adjust the length of the strap thanks to the two buttons on the buckle, which can also be used while wearing gloves. The frame is colored with a paint effect that makes the mask elegant and beautiful to see, which can be coordinated with your equipment.

3 LENS PANORAMIC DESIGN

TEMPERED GLASS

MICROMETRIC ADJUSTABLE BUCKLE

FLEXIBLE BUCKLE

100% HIGH QUALITY SILICONE SKIRT

### TECHNICAL FEATURES

- Three-lens panoramic design for excellent peripheral vision.
- Lightweight, durable polycarbonate frame.
- Soft silicone skirt fits a wide range of face shapes.
- Fast-adjust ratcheting strap buckles.
- Easy-access nose pocket for equalization.
- Lenses made in tempered glass.

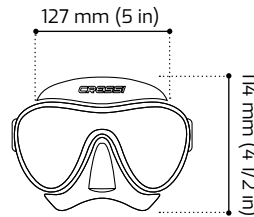

BLACK/SAPPHIRE



BLACK/GRAPHITE



CLEAR/YELLOW/SILVER



CLEAR/BLUE/SILVER



BLACK/RED/SILVER



PRODUCT	PACK	CODE	DLR €	10%	SEASONAL ORDER 20%	RRP €
LIBERTY TRISIDE SPE MASK BLACK/SAPPHIRE	6	DS455020	51,88	46,69	41,50	84,99
LIBERTY TRISIDE SPE MASK BLACK/GRAPHITE	6	DS455050	51,88	46,69	41,50	84,99
LIBERTY TRISIDE SPE MASK CLEAR/YELLOW/SILVER	6	DS450015	51,88	46,69	41,50	84,99
LIBERTY TRISIDE SPE MASK CLEAR/BLUE/SILVER	6	DS450025	51,88	46,69	41,50	84,99
LIBERTY TRISIDE SPE MASK BLACK/RED/SILVER	6	DS455058	51,88	46,69	41,50	84,99



# ACTION

## MASK FOR ACTION CAM

Mask based on FOCUS model that incorporates an adaptor on the frame for easy assembly of Action Cam cameras. The frame has been reinforced in thickness in the assembly area of the camera and includes by default the screw with fixing knob and

camera inclination adjustment. Buckles rotate 100% in all directions thanks to the flexible anchorage and allow a microadjustment with one hand by means of a button.

MICROMETRIC ADJUSTABLE BUCKLE | TEMPERED GLASS | 100% HIGH QUALITY SILICONE SKIRT

### TECHNICAL FEATURES

- Skirt with more than 85% of adaptability
- Adjustable 360° rotating buckles
- Skirt and strap made of clear or black liquid silicone
- Internal volume 130 cm<sup>3</sup>
- Weight 190 g

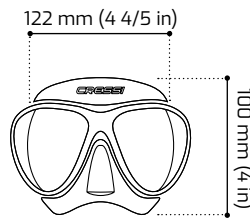

CLEAR/CLEAR

CLEAR/BLUE

BLACK

BLACK/BLUE

PRODUCT	PACK	CODE	DLR €	10%	SEASONAL ORDER 20%	RRP €
ACTION MASK SIL CLEARL/FRAME CLEAR	6	DS410060	46.24	41.62	36.99	74.99
ACTION MASK SIL CLEAR/FRAME BLUE	6	XDS410020	46.24	41.62	36.99	74.99
ACTION MASK SIL BLACK/FRAME BLACK	6	DS415050	46.24	41.62	36.99	74.99
ACTION MASK SIL BLACK/FRAME BLUE	6	XDS415020	46.24	41.62	36.99	74.99

# MINIMA

## THE LOWEST VOLUME ON THE MARKET

This mask was designed specifically for deep sea diving, with innovative features that place it at the top of its category. The special reduced skirt, complete with a small seal ring, sticks like a suction cup to the face, leaving minimum air space inside the mask, which make compensation extremely easy, taking very little air from the lungs.

The lens-eye distance is the absolute smallest on the market and guarantees, even with small diameter lenses, excellent visibility in all directions. The two optic glass lenses are thicker than the standard to allow a special safety mould. The strap comes with instantly adjusting buckles for an easy and precise fit.

- REDUCED SKIRT
- EASY COMPENSATION
- EXCELLENT VISIBILITY
- ADJUSTING BUCKLE
- 100% HIGH QUALITY SILICONE SKIRT

### TECHNICAL FEATURES

- Materials: liquid silicone, hi-tech polymers
- Strap buckles: instant adjustment
- Internal very low volume
- Dimensions of frame: 168 x 45 mm
- Weight: 118 g

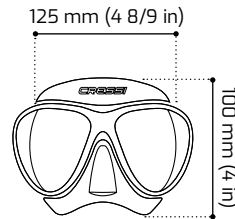

PRODUCT	PACK	CODE	DLR €	10%	SEASONAL ORDER 20%	RRP €
MINIMA MASK BLACK/BLACK	6	DS292050	33,74	30,37	26,99	54,99



# SUPEROCCHIO

## CLASSIC LOW VOLUME MASK

A huge classic in Cressi masks, it continues to be a favourite among fans even though it has been in production for many years. It's a small mask with minimum internal volume, very well suited for

deep freediving. The size of the skirt is limited, and the mask adapts easily to many facial shapes. The two separate lenses, placed very near the eyes, offer great visibility in every direction.

- EASY ADJUSTABLE BUCKLE
- TEMPERED GLASS
- 100% HIGH QUALITY SILICONE SKIRT

### TECHNICAL FEATURES

- Minimum internal volume
- Suitable for deep freediving
- The size of the skirt is reduced, and the mask adapts easily to many facial shapes
- The two separate lenses, placed very near the eyes, offer great visibility in every direction
- Made in Italy

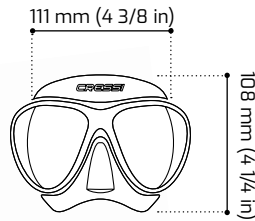

PRODUCT	PACK	CODE	DLR €	10%	SEASONAL ORDER 20%	RRP €
SUPEROCCHIO MASK SIL BLACK/FRAME BLACK	12	DN234650	33.74	30.37	26.99	54.99





# MASKS OPTICAL LENSES

## FOCUS MASK - NEGATIVE CORRECTION

Symmetrical Lens, from -1.00 to -8.00 diopters with 0.5 diopter intervals

PRODUCTS	CODE	DLR €	10%	SEASONAL ORDER 20%	RRP €
OPT.LENS FOCUS - 1.0 DX/SX	DI240010	31,88	28,69	25,50	55,99
OPT.LENS FOCUS - 1.5 DX/SX	DI240015	31,88	28,69	25,50	55,99
OPT.LENS FOCUS - 2.0 DX/SX	DI240020	31,88	28,69	25,50	55,99
OPT.LENS FOCUS - 2.5 DX/SX	DI240025	31,88	28,69	25,50	55,99
OPT.LENS FOCUS - 3.0 DX/SX	DI240030	31,88	28,69	25,50	55,99
OPT.LENS FOCUS - 3.5 DX/SX	DI240035	31,88	28,69	25,50	55,99
OPT.LENS FOCUS - 4.0 DX/SX	DI240040	31,88	28,69	25,50	55,99
OPT.LENS FOCUS - 4.5 DX/SX	DI240045	31,88	28,69	25,50	55,99
OPT.LENS FOCUS - 5.0 DX/SX	DI240050	31,88	28,69	25,50	55,99
OPT.LENS FOCUS - 5.5 DX/SX	DI240055	31,88	28,69	25,50	55,99
OPT.LENS FOCUS - 6.0 DX/SX	DI240060	31,88	28,69	25,50	55,99
OPT.LENS FOCUS - 6.5 DX/SX	DI240065	31,88	28,69	25,50	55,99
OPT.LENS FOCUS - 7.0 DX/SX	DI240070	31,88	28,69	25,50	55,99
OPT.LENS FOCUS - 7.5 DX/SX	DI240075	31,88	28,69	25,50	55,99
OPT.LENS FOCUS - 8.0 DX/SX	DI240080	31,88	28,69	25,50	55,99

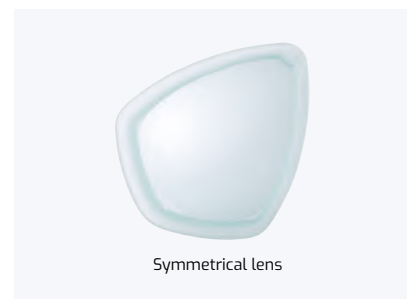

# MASKS OPTICAL LENSES

## QUANTUM, BIG EYES EVO. MASKS - NEGATIVE CORRECTION

Asymmetrical Lenses, from -1.00 to -6.00 diopters with 0.5 diopter intervals

PRODUCTS	DX - RIGHT	SX - LEFT	DLR €	10%	SEASONAL ORDER 20%	RRP €
QUANTUM - BIG EYES EVO OPT.LENS -1.00	DI336010	DI336110	34,99	31,49	27,99	59,99
QUANTUM - BIG EYES EVO OPT.LENS -1.50	DI336015	DI336115	34,99	31,49	27,99	59,99
QUANTUM - BIG EYES EVO OPT.LENS -2.00	DI336020	DI336120	34,99	31,49	27,99	59,99
QUANTUM - BIG EYES EVO OPT.LENS -2.50	DI336025	DI336125	34,99	31,49	27,99	59,99
QUANTUM - BIG EYES EVO OPT.LENS -3.00	DI336030	DI336130	34,99	31,49	27,99	59,99
QUANTUM - BIG EYES EVO OPT.LENS -3.50	DI336035	DI336135	34,99	31,49	27,99	59,99
QUANTUM - BIG EYES EVO OPT.LENS -4.00	DI336040	DI336140	34,99	31,49	27,99	59,99
QUANTUM - BIG EYES EVO OPT.LENS -4.50	DI336045	DI336145	34,99	31,49	27,99	59,99
QUANTUM - BIG EYES EVO OPT.LENS -5.00	DI336050	DI336150	34,99	31,49	27,99	59,99
QUANTUM - BIG EYES EVO OPT.LENS -5.50	DI336055	DI336155	34,99	31,49	27,99	59,99
QUANTUM - BIG EYES EVO OPT.LENS -6.00	DI336060	DI336160	34,99	31,49	27,99	59,99

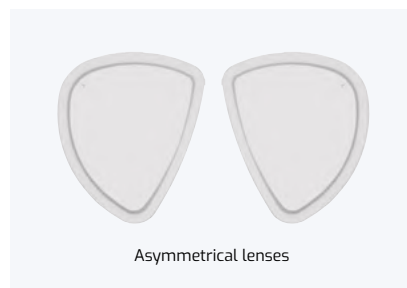

## QUANTUM, BIG EYES EVO. MASKS - POSITIVE CORRECTION

Asymmetrical Bifocal Lenses, from +1.00 to +3.00 diopters with 0.5 diopter intervals

**NEW 2023**

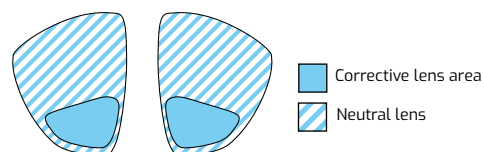

PRODUCTS	DX - RIGHT	SX - LEFT	DLR €	10%	SEASONAL ORDER 20%	RRP €
QUANTUM - BIG EYES EVO OPT.LENS +1.00	DI335010	DI335110	43,74	39,37	34,99	74,99
QUANTUM - BIG EYES EVO OPT.LENS +1.50	DI335015	DI335115	43,74	39,37	34,99	74,99
QUANTUM - BIG EYES EVO OPT.LENS +2.00	DI335020	DI335120	43,74	39,37	34,99	74,99
QUANTUM - BIG EYES EVO OPT.LENS +2.50	DI335025	DI335125	43,74	39,37	34,99	74,99
QUANTUM - BIG EYES EVO OPT.LENS +3.00	DI335030	DI335130	43,74	39,37	34,99	74,99

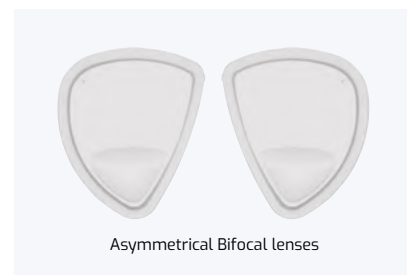

/ MASKS ACCESSORIES

## DISPLAY FOR ANTIFOG

ANTIFOG NOT INCLUDED



CODE	DLR €	10%	SEASONAL ORDER 20%	RRP €
VAESPOAF	44,99	40,49	35,99	-

## ANTIFOG 0% ALCOHOL

60 ML



Effective anti-fog for masks and goggles. Spread on the inside of the lenses, before wetting them.

CODE	DLR €	10%	SEASONAL ORDER 20%	RRP €
DF200050	6,56	5,90	5,25	11,99

## ANTIFOG 0% ALCOHOL

60 ML (X2)



Effective anti-fog for masks and goggles. Spread on the inside of the lenses, before wetting them.

CODE	DLR €	10%	SEASONAL ORDER 20%	RRP €
XDF200201	9,38	8,44	7,50	17,50

## ANTIFOG GEL 0% ALCOHOL

30 ML



Effective anti-fog for masks and goggles. Spread on the inside of the lenses, before wetting them.

CODE	DLR €	10%	SEASONAL ORDER 20%	RRP €
DF200052	5,31	4,78	4,25	9,99

## MASK STRAP COVER

SOFT NEOPRENE STRAP COVER



COLOR	CODE	DLR €	10%	SEASONAL ORDER 20%	RRP €
BLUE	DS339992	11,24	10,12	8,99	18,99
PINK	DS339994	11,24	10,12	8,99	18,99
BLACK	DS339995	11,24	10,12	8,99	18,99







# SNORKELLING MASKS

Photo by: Javier Ferrer



# FIJI NEW 2023

PATENTED ANTI-FOG SYSTEM

DOUBLE INJECTION TECHNOLOGY

INCLINED LENSES

TEXTILE STRAP

TEMPERED GLASS

100% HIGH QUALITY SILICONE SKIRT

## ADVANCED ANTI-FOG SYSTEM + TEXTILE STRAP MASK

Fiji is a snorkeling mask that features the ultimate Cressi Fog Stop System.

A system of membranes channels the air towards the lower part of the mask, away from the glasses. A second membrane seals the eye socket, so that warm air coming from exhalation does not get on contact with the glass at all. This dramatically limits the fogging of the mask. Another feature of our fog stop system is the heat exchanging structure on the top of the mask silicone blades facilitate heat exchange between the mask and the water, balancing the temperature between the two in a shorter time. This also helps to reduce fogging. Fiji is a mask thought for snorkeling. It features an elastic band, making it an easy to

use mask, that will be appreciated by beginners, people with long hair. It can be used for scuba diving too, but keep in mind that an elastic strap is not as firm as a silicon one. The lenses are not treated chemically and it should be remembered that when the mask is new, as is the case with all masks, we advise you to clean them well with a strong soap (toothpaste, dishwashing liquid soap, degreaser). Also use perform the normal antifogging procedure before using the mask, with an anti-fog spray or saliva on the dry glass.

### INNER MEMBRANES

A patented membrane surrounding the inner nose pocket (1) and both the inner eyes pockets (2) which acts as a barrier and traps any moisture escaping from the diver's nose involuntarily when breathing through the mouth. The result is that not only is the moisture channeled away from the lenses, thus avoiding the fogging up of them, but it also reduces the need to compensate for pressure.

To further improve the anti-fog effect, Cressi suggests, the first times that the dive mask is used, to spray some anti-fog solution or to apply some saliva on the inside of the lenses and then to rinse them with water.

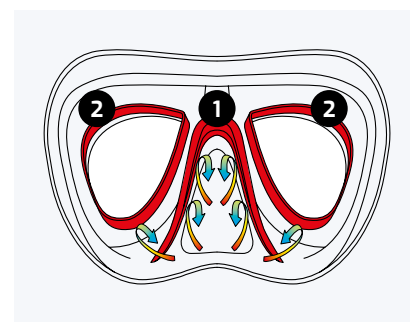
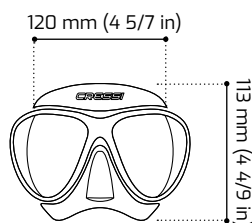

### HEAT EXCHANGER

The external part of the skirt features a cooling system composed of two small heat exchangers that act as radiators (3). Thanks to this system, the temperature inside mask drops, coming closer to the external temperature and the droplets of humidity are trapped before the air reaches the lenses, preventing them from fogging up.



### NEW TEXTILE ELASTIC STRAP



PRODUCT	PACK	CODE	DLR €	10%	SEASONAL ORDER 20%	RRP €
FIJI MASK BLACK/BLUE	6	DN225020	24,99	22,49	19,99	44,99
FIJI MASK BLACK/BLACK	6	DN225050	24,99	22,49	19,99	44,99
FIJI MASK CLEAR/AQUAMARINE	6	DN220025	24,99	22,49	19,99	44,99
FIJI MASK CLEAR/BLUE	6	DN220020	24,99	22,49	19,99	44,99

# SAMOA NEW 2023

PATENTED ANTI-FOG SYSTEM

DOUBLE INJECTION TECHNOLOGY

TEXTILE STRAP

TEMPERED GLASS

100% HIGH QUALITY SILICONE SKIRT

## ADVANCED ANTI-FOG SYSTEM + TEXTILE STRAP MASK

Fiji is a snorkeling mask that features the ultimate Cressi Fog Stop System.

A system of membranes channels the air towards the lower part of the mask, away from the glasses. A second membrane seals the eye socket, so that warm air coming from exhalation does not get on contact with the glass at all. This dramatically limits the fogging of the mask. Another feature of our fog stop system is the heat exchanging structure on the top of the mask's silicone blades facilitate heat exchange between the mask and the water, balancing the temperature between the two in a shorter time. This also helps to reduce fogging. Fiji is a mask thought for snorkeling. It features an elastic band, making it an easy to

use mask, that will be appreciated by beginners, people with long hair. It can be used for scuba diving too, but keep in mind that an elastic strap is not as firm as a silicon one. The lenses are not treated chemically and it should be remembered that when the mask is new, as is the case with all masks, we advise you to clean them well with a strong soap (toothpaste, dishwashing liquid soap, degreaser). Also use perform the normal antifogging procedure before using the mask, with an anti-fog spray or saliva on the dry glass.

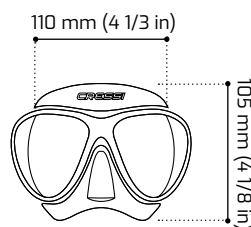

BLACK/BLACK

BLACK/AQUAMARINE

CLEAR/BLUE

CLEAR/PINK

PRODUCT	PACK	CODE	DLR €	10%	SEASONAL ORDER 20%	RRP €
SAMOA MASK BLACK/BLACK	6	DN245050	24,99	22,49	19,99	44,99
SAMOA MASK CLEAR/AQUAMARINE	6	DN240025	24,99	22,49	19,99	44,99
SAMOA MASK CLEAR/BLUE	6	DN240020	24,99	22,49	19,99	44,99
SAMOA MASK CLEAR/PINK	6	DN240040	24,99	22,49	19,99	44,99

### INNER MEMBRANES

A patented membrane surrounding the inner nose pocket (1) and both the inner eyes pockets (2) which acts as a barrier and traps any moisture escaping from the diver's nose involuntarily when breathing through the mouth. The result is that not only is the moisture channeled away from the lenses, thus avoiding the fogging up of them, but it also reduces the need to compensate for pressure.

To further improve the anti-fog effect, Cressi suggests, the first times that the dive mask is used, to spray some anti-fog solution or to apply some saliva on the inside of the lenses and then to rinse them with water.

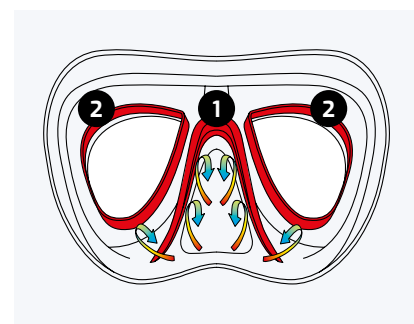

### HEAT EXCHANGER

The external part of the skirt features a cooling system composed of two small heat exchangers that act as radiators (3). Thanks to this system, the temperature inside mask drops, coming closer to the external temperature and the droplets of humidity are trapped before the air reaches the lenses, preventing them from fogging up.



### NEW TEXTILE ELASTIC STRAP



# ESTRELLA

## ADULT SIZE

The quality of the assembly and of the materials is the same as the most technical range: unbreakable tempered glass, polycarbonate frame of reduced thickness and weight, simple and resistant buckles integrated into the frame and in the front-side, silicone strap. Its design is studied to obtain a very wide vision in all directions.

Buckles 100% swiveling in all directions thanks to the flexible anchorage, and micro-adjustment with one hand at the push of a button. They avoid the usual breakage of this critical point and maintain the stability of the mask, once positioned and with the strap on.

- WINDOW 1
- MICROMETRIC ADJUSTABLE BUCKLE
- TEMPERED GLASS
- 100% HIGH QUALITY SILICONE SKIRT



PRODUCT	PACK	CODE	DLR €	10%	SEASONAL ORDER 20%	RRP €
ESTRELLA MASK CLEAR/BLUE	6	DN340020	18,74	16,87	14,99	34,99
ESTRELLA MASK CLEAR/AQUAMARINE	6	DN340063	18,74	16,87	14,99	34,99
ESTRELLA MASK CLEAR/BLACK	6	DN340050	18,74	16,87	14,99	34,99
ESTRELLA MASK CLEAR/PINK	6	DN340040	18,74	16,87	14,99	34,99
ESTRELLA MASK ASS. COL.	12	DN340099	18,74	16,87	14,99	34,99
ESTRELLA MASK BLACK/BLACK	6	DN345050	18,74	16,87	14,99	34,99
ESTRELLA MASK BLACK/BLUE	6	DN345020	18,74	16,87	14,99	34,99





# MAREA

## ADULT SIZE

Evolution of the legendary Focus model, the most versatile and one of the most successful Cressi masks. The frame design is minimized in thickness and the lenses are slightly angled to improve vertical and horizontal visibility. Buckles with flexible anchorage 100% pivoting in all directions thanks to its flexible anchorage and

with micro adjustment by button, with one hand. They avoid the usual breakages in this delicate point and maintain the stability of the mask once positioned and with the strap pulled. 100% multi-purpose mask suitable for apnea, snorkeling and diving. Very resistant also for use in diving centers or intensive use.

2 WINDOW MASK

MICROMETRIC ADJUSTABLE BUCKLE

TEMPERED GLASS

100% HIGH QUALITY SILICONE SKIRT

### TECHNICAL FEATURES

- Type: double-lenses mask.
- Internal volume: 130cm<sup>3</sup> weight 165 gr (junior 80cm<sup>3</sup> 120 gr).
- Clear silicone or dark silicone strap and skirt.
- 360° adjustable pivoting buckles, perfect also for diving centers' usage or intensive use.
- Skirt with adaptable percentage of more than 85%.

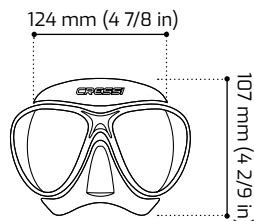

YELLOW



BLUE



LILAC



COLORAMA ASSORTED



CLEAR/YELLOW



CLEAR/BLUE



CLEAR/PINK



CLEAR/BLACK



CLEAR ASSORTED



BLACK



PRODUCT	PACK	CODE	DLR €	10%	SEASONAL ORDER 20%	RRP €
MAREA MASK SIL YELLOW	6	DN282010	19.99	17.99	15.99	34.99
MAREA MASK SIL BLUE	6	DN282020	19.99	17.99	15.99	34.99
MAREA MASK SIL LILAC	6	DN282041	19.99	17.99	15.99	34.99
MAREA MASK SIL ASSORTED	12	DN282099	19.99	17.99	15.99	34.99
MAREA MASK SIL CLEAR/YELLOW	6	DN281010	19.38	17.44	15.50	32.99
MAREA MASK SIL CLEAR BLUE	6	DN281020	19.38	17.44	15.50	32.99
MAREA MASK SIL CLEAR PINK	6	DN281040	19.38	17.44	15.50	32.99
MAREA MASK SIL CLEAR/BLACK	6	DN281060	19.38	17.44	15.50	32.99
MAREA MASK SIL CLEAR /FRAME ASSORTED	12	DN281000	19.38	17.44	15.50	32.99
MAREA MASK SIL BLACK/FRAME BLACK	6	DN285050	19.38	17.44	15.50	32.99



/ SNORKELING MASKS

# OCEAN

## ADULT SIZE

The patented concept of raked lenses and their special "inverted drop" is developed further here. The lenses are placed as closely as possible to the eyes, with the further increase in the field of vision taken to the maximum levels possible. The soft silicone skirt has a new profile and a wide sealing ring for excellent grip and unprecedented comfort. The internal volume of the mask is exceptionally low, lower than that of many free diving models and the weight is decidedly low. Two pressure buckles, integrated into the headband, allow for quick and accurate adjustment of the strap.



- 2 WINDOW MASK
- MICROMETRIC ADJUSTABLE BUCKLE
- TEMPERED GLASS
- 100% HIGH QUALITY SILICONE SKIRT

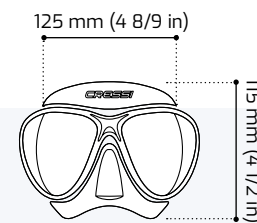

PRODUCT	PACK	CODE	DLR €	10%	SEASONAL ORDER 20%	RRP €
OCEAN MASK SIL CLEAR/FRAME BLACK	6	DN291050	21.88	19.69	17.50	39.99
OCEAN MASK SIL CLEAR/FRAME CLEAR	6	DN291060	21.88	19.69	17.50	39.99
OCEAN MASK SIL CLEAR/FRAME AQUAMARINE	6	DN291063	21.88	19.69	17.50	39.99
OCEAN MASK SIL/FRAME ASSORTED	12	DN291099	21.88	19.69	17.50	39.99
OCEAN MASK BLACK/BLACK	6	DN295050	21.88	19.69	17.50	39.99



# SKY

## ADULT SIZE

Modern, single lens mask, with a very attractive look. The soft silicone skirt complete with broad internal seal ring, offers great comfort even with prolonged use. The very streamlined frame guarantees good visibility in every direction. The strap buckles are revolving, for instant adjustment. Excellent mask for general use: snorkeling, scuba diving.



- 1 WINDOW MASK
- MICROMETRIC ADJUSTABLE BUCKLE
- TEMPERED GLASS

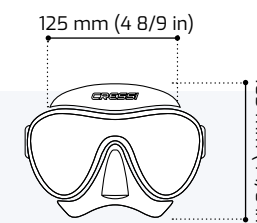

### TECHNICAL FEATURES

- Type: single lens mask
- Materials: liquid silicone, hi-tech polymers
- Strap buckles: revolving, instant adjustment
- Internal volume: normal
- Dimensions of frame: 165 x 80 mm
- Weight: 200 g

PRODUCT	PACK	CODE	DLR €	10%	SEASONAL ORDER 20%	RRP €
SKY MASK SIL/FRAME ASSORTED	12	DN200000	19.99	17.99	15.99	34.99



/ SNORKELING MASKS

# ONDA

## ADULT SIZE

This mask has a single tempered glass lens, and is designed for snorkeling, swimming and scuba diving. The skirt is made from soft hypoallergenic transparent silicone. The visibility provided by the

single lens and the unusual shape of the frame extends in all directions. Excellent seal on many face types, average internal volume.

WINDOW 1

MICROMETRIC ADJUSTABLE BUCKLE

TEMPERED GLASS

100% HIGH QUALITY SILICONE SKIRT

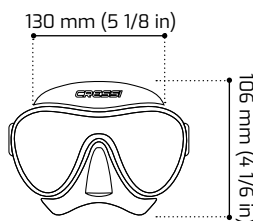

CLEAR/YELLOW



CLEAR/BLUE



CLEAR/PINK



BLACK



ASSORTED

PRODUCT	PACK	CODE	DLR €	10%	SEASONAL ORDER 20%	RRP €
ONDA MASK SIL CLEAR/FRAME YELLOW	6	DN207010	16,88	15,19	13,50	27,99
ONDA MASK SIL CLEAR/FRAME BLUE	6	DN207020	16,88	15,19	13,50	27,99
ONDA MASK SIL CLEAR/FRAME PINK	6	DN207040	16,88	15,19	13,50	27,99
ONDA MASK SIL BLACK/FRAME BLACK	6	DN207150	16,88	15,19	13,50	27,99
ONDA MASK SIL/FRAME ASSORTED	12	DN207000	16,88	15,19	13,50	27,99





# PERLA

## ADULT SIZE

A mask particularly suitable for free diving and snorkeling, but just as appropriate for use in scuba diving. It has separate lenses, a skirt edge fitting most of the faces and a small inner volume, perfect for free-divers. Unbreakable tempered glass, polycarbonate frame.

It is made from soft transparent or dark silicone, and comes with strong rapid action buckles to adjust the strap. The quality of the assembly and of the materials is the same as the most technical range.

WINDOW 2

MICROMETRIC ADJUSTABLE BUCKLE

TEMPERED GLASS

100% HIGH QUALITY SILICONE SKIRT

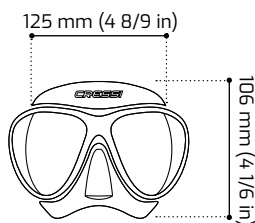

BLACK



GREEN/BLACK



CLEAR/BLUE



CLEAR/PINK



CLEAR/BLACK



CLEAR/AQUAMARINE



ASSORTED

PRODUCT	PACK	CODE	DLR €	10%	SEASONAL ORDER 20%	RRP €
PERLA MASK SIL BLACK/FRAME BLACK	6	DN208150	14.38	12.94	11.50	24.99
PERLA MASK SIL GREEN/FRAME BLACK	6	DN208198	14.38	12.94	11.50	24.99
PERLA MASK SIL/FRAME ASSORTED	12	DN208000	14.38	12.94	11.50	24.99
PERLA MASK CLEAR/BLUE	6	DN207920	14.38	12.94	11.50	24.99
PERLA MASK CLEAR/PINK	6	DN207940	14.38	12.94	11.50	24.99
PERLA MASK CLEAR/BLACK	6	DN207950	14.38	12.94	11.50	24.99
PERLA MASK CLEAR/AQUAMARINE	6	DN207963	14.38	12.94	11.50	24.99



# SIRENA

## ADULT SIZE

This Sirena has a single tempered glass lens and is designed for snorkeling, swimming and scuba diving. The skirt is made from soft hypoallergenic transparent or black silicone. The visibility provided by the single lens and the unusual shape of the frame extends in all directions. Excellent seal on most face types, thanks to the internal seal ring housing average internal volume. It has quick-release strap buckles.

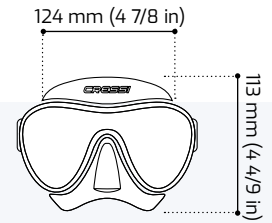

BLACK/SMOKED BLACK



ASSORTED



BLACK/RED



PRODUCT	PACK	CODE	DLR €	10%	SEASONAL ORDER 20%	RRP €
SIRENA MASK SIL/FRAME ASSORTED.	12	DN201000	13.74	12.37	10.99	22.99
SIRENA MASK SIL BLACK/FRAME SMOKED BLACK	6	DN202000	13.74	12.37	10.99	22.99
SIRENA MASK SIL BLACK/FRAME RED	6	JDN200058	13.74	12.37	10.99	22.99



# PINOCCHIO

## ADULT SIZE CLASSIC MASK

A real CULT when it comes to masks, Pinocchio is the most famous mask in the world. It began life in the first half of the '50s, and was the first mask that came with a special lodging for the nose, making compensation possible. Adored by entire diving generations all over the world, its design was so advanced at the time it was launched on the market, that it is still valid today, fifty years down the track.

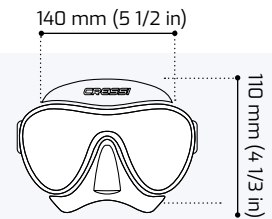

**FIRST MASK WITH A NOSE POCKET SINCE 1952**

PRODUCT	PACK	CODE	DLR €	10%	SEASONAL ORDER 20%	RRP €
PINOCCHIO MASK BLACK/FRAME BLACK	12	DN210000	19.99	17.99	15.99	34.99







SNORKELING MASKS JUNIOR



# ESTRELLA JUNIOR

## WITH TEXTILE STRAP - AGE 7-13

This new version of the Estrella has an elasticated fabric strap without adjustment buckles to make it easier for children to put on and to avoid pulling the hair. The traditional snorkel clip has been replaced with a loop created with the fabric strap

supporting and positioning the snorkel. The same mask can be fitted with both the silicon and fabric straps via an attachment pin.

WINDOW 1

TEMPERED GLASS

100% HIGH QUALITY SOFT CLEAR SILICONE SKIRT

### TECHNICAL FEATURES

- Kids diving mask for kids from 7 to 13 years old.
- Suitable for snorkeling and also scuba diving.
- Single tempered glass lens

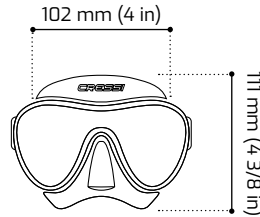

NEW STRAP, EASIER FOR CHILDREN TO PUT ON



SNORKEL LOOP CREATED WITH THE FABRIC STRAP



BLUE

GREEN

CLEAR/AQUAMARINE

CLEAR PINK



ASSORTED

PRODUCT	PACK	CODE	DLR €	10%	SEASONAL ORDER 20%	RRP €
ESTRELLA JR TXLE STRAP MASK BLUE	6	DN351050	19,99	17,99	15,99	34,99
ESTRELLA JR TXLE STRAP MASK GREEN	6	DN351090	19,99	17,99	15,99	34,99
ESTRELLA JR TXLE STRAP MASK CLEAR/AQUAM	6	DN351025	19,99	17,99	15,99	34,99
ESTRELLA JR TXLE STRAP MASK CLEAR/PINK	6	DN351040	19,99	17,99	15,99	34,99
ESTRELLA JR TXLE STRAP MASK ASS. COL.	12	DN351099	19,99	17,99	15,99	34,99



# MAREA JUNIOR

## AGE 7-13

The Marea Junior is a 2 Windowed Mask that is particularly suitable for scuba diving and snorkeling. It has dual tempered glass lenses, a double feathered skirt edge that adapts to most faces and a small inner volume that is perfect when going deep underwater. The Marea Junior is made from 100% clear high-quality sealing soft silicone rubber that offers extraordinary and unprecedented comfort and fit.

Designed for younger and women divers the Marea Junior Mask gives an exceptionally wide field of view. Mask is equipped with Cressi's micrometric easy adjust buckles and has a wide silicone rubber split strap designed mask strap for even dispersion of pressure for increased fit and comfort. Mask has an easy-to-reach one-hand nose pocket for ear equalization.

### TECHNICAL FEATURES

- Scuba, free diving and snorkeling mask
- Dual tempered glass lens for durability.
- Easy Adjustable buckle.
- 100% High Quality Silicone.
- Wide field of view.
- Soft silicone mask skirt for comfort.
- Designed for women and younger divers.

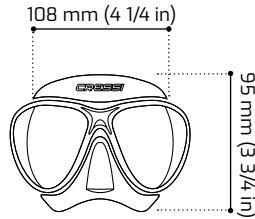

PRODUCT	PACK	CODE	DLR €	10%	SEASONAL ORDER 20%	RRP €
MAREA JR MASK SIL BLUE	6	DN284020	18,74	16,87	14,99	29,99
MAREA JR MASK SIL LILAC	6	DN284041	18,74	16,87	14,99	29,99
MAREA JR MASK SIL ASSORTED	12	DN284099	18,74	16,87	14,99	29,99
MAREA JR MASK SIL CLEAR YELLOW	6	DN283010	16,88	15,19	13,50	27,99
MAREA JR MASK SIL CLEAR BLUE	6	DN283020	16,88	15,19	13,50	27,99
MAREA JR MASK SIL CLEAR PINK	6	DN283040	16,88	15,19	13,50	27,99
MAREA JR MASK SIL CLEAR ASSORTED	12	DN283000	16,88	15,19	13,50	27,99



# ONDINA JUNIOR

NEW COLOR 2023

WINDOW 1 EASY ADJUSTABLE BUCKLE TEMPERED GLASS 100% HIGH QUALITY SILICONE SKIRT

## AGE 7-13

Smaller version of the Onda mask, suitable for young people and women with narrow faces. This mask has a single lens, and is designed for snorkeling, swimming and scuba diving. The skirt is made from soft hypoallergenic transparent silicone. The visibility provided by the single lens and the unusual shape of the frame extends in all directions. Excellent seal on many face types, small internal volume. Quick-release strap buckles.

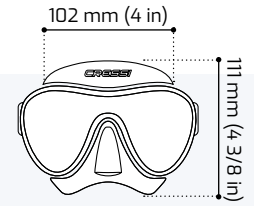

CLEAR/AQUAMARINE CLEAR/YELLOW CLEAR/PINK ASSORTED

PRODUCT	PACK	CODE	DLR €	10%	SEASONAL ORDER 20%	RRP €
ONDINA JR MASK SIL CLEAR/FRAME YELLOW	6	DN206910	14,99	13,49	11,99	24,99
ONDINA JR MASK SIL CLEAR/FRAME AQUAMARINE	6	DN206925	14,99	13,49	11,99	24,99
ONDINA JR MASK SIL CLEAR/FRAME PINK	6	DN206940	14,99	13,49	11,99	24,99
ONDINA JR MASK SIL/FRAME ASSORTED.	12	DN206900	14,99	13,49	11,99	24,99



# PERLA JUNIOR

## AGE 7-13

Smaller version of the PERLA mask, suitable for women and young people. This mask has separate lenses, a skirt edge that adapts to most faces and a small inner volume, perfect for free-divers. The skirt is made from soft hypoallergenic transparent silicone. The visibility provided by the double lens and the unusual shape of the frame extends in all directions. Excellent seal on many face types. Quick-release strap buckles.



WINDOW 2 EASY ADJUSTABLE BUCKLE TEMPERED GLASS 100% HIGH QUALITY SILICONE SKIRT

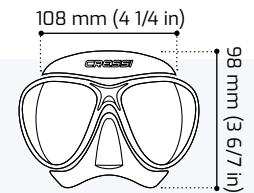

CLEAR/BLUE CLEAR/PINK CLEAR/AQUAMARINE CLEAR/LIME ASSORTED

PRODUCT	PACK	CODE	DLR €	10%	SEASONAL ORDER 20%	RRP €
PERLA JR MASK CLEAR/BLUE	6	DN208420	14,38	12,94	11,50	22,99
PERLA JR MASK CLEAR/PINK	6	DN208440	14,38	12,94	11,50	22,99
PERLA JR MASK CLEAR/AQUAMARINE	6	DN208463	14,38	12,94	11,50	22,99
PERLA JR MASK CLEAR/LIME	6	DN208467	14,38	12,94	11,50	22,99
PERLA JR MASK SIL/FRAME ASSORTED	12	DN208300	14,38	12,94	11,50	22,99





# SIRENETTA JUNIOR

AGE 7-13

The Sirenetta is the smaller version of the popular Sirena mask, mainly designed for women and young divers. This mask has a single lens and is designed for snorkeling, swimming and scuba diving. The visibility provided by the single lens and the unusual shape of the frame extends in all directions. The skirt is made of soft hypoallergenic silicone that adapts at the face ensuring comfort and a perfect seal. The strap is slit and made of silicone to ensure comfort and a perfect hold. The length of the strap is easy to adjust thanks to the quick-release strap buckles.

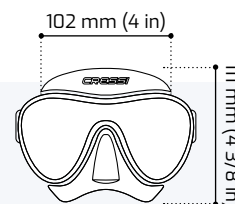

BLACK



ASSORTED



PRODUCT	PACK	CODE	DLR €	10%	SEASONAL ORDER 20%	RRP €
SIRENETTA JR MASK SIL/FRAME ASSORTED.	12	DN203000	13,13	11,82	10,50	21,99
SIRENETTA JR MASK BLACK	6	DN203150	13,13	11,82	10,50	21,99

# MOON

AGE 5-10

Perfect for swimming, snorkeling and enjoy the underwater nature. Shatterproof lenses with anti-scratch treatment. Perfect adaptability to a wide range of facial profiles. Micrometric indestructible buckles. Ability to instantly replace the complex-strap buckles with other models in the Cressi range.



WINDOW 2 EASY ADJUSTABLE BUCKLE



CLEAR/LIME



CLEAR/BLUE



CLEAR/LILAC



PINK/LILAC



LIGHT BLUE/LIME



BLUE/ORANGE



PINK/WHITE



ASSORTED

PRODUCT	PACK	CODE	DLR €	10%	SEASONAL ORDER 20%	RRP €
MOON KID MASK SIL CLEAR/FRAME LIME	6	DN200667	14,38	12,94	11,50	24,99
MOON KID MASK SIL CLEAR/FRAME BLUE	6	DN200620	14,38	12,94	11,50	24,99
MOON KID MASK SIL CLEAR/FRAME LILAC	6	DN200641	14,38	12,94	11,50	24,99
MOON KID MASK SIL LIGHT BLUE/FRAME LIME	6	DN200720	14,38	12,94	11,50	24,99
MOON KID MASK SIL PINK/FRAME LILAC	6	DN200740	14,38	12,94	11,50	24,99
MOON KID MASK BLUE/ORANGE	6	DN200828	14,38	12,94	11,50	24,99
MOON KID MASK PINK/WHITE	6	DN200834	14,38	12,94	11,50	24,99
MOON KID MASK SIL/FRAME ASSORTED	12	DN200600	14,38	12,94	11,50	24,99



# PIUMETTA KID

**AGE 3-7**

Piumetta is not only a minimized version of a senior diving mask, as we already produce a junior version called the Ondina, rather all of the dimensions have been reconfigured for optimum adaptation to the physiology of smaller individuals. Thus, not only the critical frame contact areas

(nose, bro, etc.) are left protected, rather the eyes are perfectly centered in the glass display for maximum visibility. Piumetta shares the frame materials and technology used in professional masks with soft Silicone and an unbreakable polycarbonate display.



PRODUCT	PACK	CODE	DLR €	10%	SEASONAL ORDER 20%	RRP €
PIUMETTA KID MASK SIL/FRAME YELLOW	6	DN200510	12,49	11,24	9,99	19,99
PIUMETTA KID MASK SIL/FRAME BLUE	6	DN200520	12,49	11,24	9,99	19,99
PIUMETTA KID MASK SIL/FRAME PINK	6	DN200540	12,49	11,24	9,99	19,99
PIUMETTA KID MASK SIL AQUAMARINE	6	DN200563	12,49	11,24	9,99	19,99
PIUMETTA KID MASK SIL/FRAME ASSORTED	12	DN200500	12,49	11,24	9,99	19,99

/ MASKS SPARE PARTS

### MASK STRAP LOOP

LARGE CLEAR (2PCS)



CODE	DLR €	10%	SEASONAL ORDER 20%	RRP €
DZ215007	2,49	2,24	1,99	3,99

### MASK STRAP LOOP

LARGE BLACK (2PCS)



CODE	DLR €	10%	SEASONAL ORDER 20%	RRP €
DZ215013	2,49	2,24	1,99	3,99

### MASK STRAP LOOP

SMALL CLEAR (2PCS)



CODE	DLR €	10%	SEASONAL ORDER 20%	RRP €
DZ215009	2,49	2,24	1,99	3,99

### MASK STRAP LOOP

SMALL BLACK (2PCS)



CODE	DLR €	10%	SEASONAL ORDER 20%	RRP €
DZ215011	2,49	2,24	1,99	3,99

### MASK STRAP

CLEAR - FOCUS / BIG EYES



CODE	DLR €	10%	SEASONAL ORDER 20%	RRP €
DZ215005	4,38	3,94	3,50	6,99

### MASK STRAP

BLACK - FOCUS / BIG EYES / SUPEROCCHIO / PINOCCHIO



CODE	DLR €	10%	SEASONAL ORDER 20%	RRP €
DZ215006	4,38	3,94	3,50	6,99

### PROFESSIONAL STRAP

CLEAR

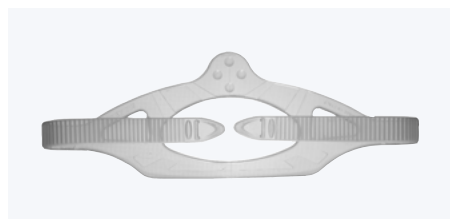

CODE	DLR €	10%	SEASONAL ORDER 20%	RRP €
DZ215003	4,99	4,49	3,99	7,99

### PROFESSIONAL STRAP

BLACK



CODE	DLR €	10%	SEASONAL ORDER 20%	RRP €
DZ215004	4,99	4,49	3,99	7,99

### STRAP CRYSTAL MASK

SILVER



CODE	DLR €	10%	SEASONAL ORDER 20%	RRP €
DZ215002	5,63	5,07	4,50	8,99

### F1 MASK STRAP

CLEAR

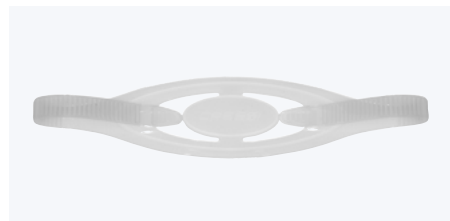

CODE	DLR €	10%	SEASONAL ORDER 20%	RRP €
DZ210023	5,63	5,07	4,50	8,99

### F1 MASK STRAP

BLACK



CODE	DLR €	10%	SEASONAL ORDER 20%	RRP €
DZ210025	5,63	5,07	4,50	8,99



/ MASKS SPARE PARTS

**BUCKLES**

BIG EYES MASK BLACK (2PCS)



CODE	DLR €	10%	SEASONAL ORDER 20%	RRP €
DZ210008	4,99	4,49	3,99	7,98

**BUCKLES**

FOCUS MASK BLACK (2PCS)



CODE	DLR €	10%	SEASONAL ORDER 20%	RRP €
DZ210010	4,99	4,49	3,99	7,99

**BUCKLES**

MATRIX / LINCE / PENTA (2PCS)



CODE	DLR €	10%	SEASONAL ORDER 20%	RRP €
DZ210018	4,99	4,49	3,99	7,99

**BUCKLES**

BIG EYES EVOLUTION / OCCHIO PLUS / EYES EVO (2PCS)

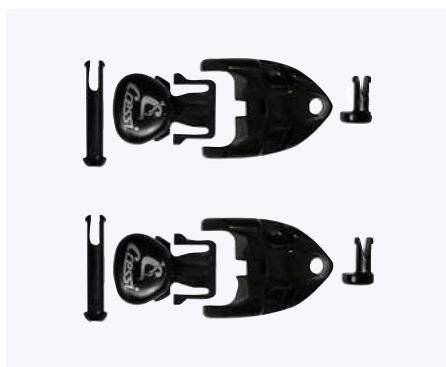

CODE	DLR €	10%	SEASONAL ORDER 20%	RRP €
DZ210021	4,99	4,49	3,99	7,99

**BUCKLES**

ONDA/INA /PERLA/JR/SIRENA/ETTA/PIUMETTA/SL A (2PCS)



CODE	DLR €	10%	SEASONAL ORDER 20%	RRP €
DZ210005	4,99	4,49	3,99	7,99

**BUCKLES**

MAREA/MAREA JR /SKY /SKY JR/OCEAN/SL B (2PCS)



CODE	DLR €	10%	SEASONAL ORDER 20%	RRP €
DZ210020	4,99	4,49	3,99	7,99

**BOX FOR MASK**



SIZE	CODE	DLR €	10%	SEASONAL ORDER 20%	RRP €
L	DZ250099	4,99	4,49	3,99	7,99
M	DZ250098	4,99	4,49	3,99	7,99

**BAG FOR COMBO SET**

BLACK



CODE	DLR €	10%	SEASONAL ORDER 20%	RRP €
DZ250095	4,99	4,49	3,99	7,99

**BAG FOR COMBO SET JR**

WHITE/BLUE



COLOR	CODE	DLR €	10%	SEASONAL ORDER 20%	RRP €
BLUE	DZ250090	4,99	4,49	3,99	7,99
PINK	DZ250091	4,99	4,49	3,99	7,99



# SNORKELLING COMBOS

Photo by: Awamare Waterwear

# QUANTUM + ITACA ULTRA DRY

**SPECIALIZED**  
Retailer-Product

PATENTED  
ANTI-FOG SYSTEM

**ADULT SIZE**



**INNER MEMBRANES**

A patented membrane surrounding the inner nose pocket and both the inner eyes pockets which acts as a barrier and traps any moisture escaping from the diver's nose involuntarily when breathing through the mouth.

**HEAT EXCHANGER**

The external part of the skirt features a cooling system composed of two small heat exchangers that act as radiators.



BLACK/BLACK

BLACK/BLUE

CLEAR/BLACK

CLEAR/BLUE

COLORS	PACK	CODE	DLR €	10%	SEASONAL ORDER 20%	RRP €
BLACK/BLACK	10	DM405050	69.38	62.44	55.50	114.99
BLACK/BLUE	10	DM405020	69.38	62.44	55.50	114.99
CLEAR/BLACK	10	DM400050	69.38	62.44	55.50	114.99
CLEAR/BLUE	10	DM400020	69.38	62.44	55.50	114.99



CM 24.5X51.5



/ SNORKELING COMBOS

# CALIBRO + CORSICA

ADULT SIZE



BLACK



GREEN



WHITE



BLUE METAL

COLORS	PACK	CODE	DLR €	10%	SEASONAL ORDER 20%	RRP €
BLACK	10	D5435050	47,49	42,74	37,99	79,99
GREEN	10	D5439850	47,49	42,74	37,99	79,99
WHITE	10	D5434030	47,49	42,74	37,99	79,99
BLUE METAL	10	D5434550	47,49	42,74	37,99	79,99



CM 24,5X51,5

# BIG EYES EVO + ALPHA ULTRA DRY

ADULT SIZE



YELLOW



BLUE



BLACK



BLACK/BLACK



BLACK/BLUE



CM 24.5X51.5

PRODUCT	PACK	CODE	DLR €	10%	SEASONAL ORDER 20%	RRP €
YELLOW	10	DS337010	53,74	48,37	42,99	89,99
BLUE	10	DS337020	53,74	48,37	42,99	89,99
BLACK	10	DS337050	53,74	48,37	42,99	89,99
BLACK/BLACK	10	WDS337550	53,74	48,37	42,99	89,99
BLACK/BLUE	10	WDS337520	53,74	48,37	42,99	89,99

# PENTA + ALPHA ULTRA DRY

ADULT SIZE



BLUE



BLACK/YELLOW



CLEAR



BLACK/BLACK



CM 24,5X51,5

COLORS	PACK	CODE	DLR €	10%	SEASONAL ORDER 20%	RRP €
BLUE	10	D5323020	46,24	41,62	36,99	79,99
BLACK/YELLOW	10	D5323010	46,24	41,62	36,99	79,99
CLEAR	10	D5323060	46,24	41,62	36,99	79,99
BLACK/BLACK	10	D5323550	46,24	41,62	36,99	79,99

# MATRIX + GAMMA

ADULT SIZE



CLEAR/BLUE



CLEAR/YELLOW



BLACK



CM 24,5X51,5

PRODUCT	PACK	CODE	DLR €	10%	SEASONAL ORDER 20%	RRP €
CLEAR/BLUE	10	D5302501	42,49	38,24	33,99	69,99
CLEAR/YELLOW	10	D5302504	42,49	38,24	33,99	69,99
BLACK	10	D5302510	42,49	38,24	33,99	69,99





# FIJI + GAMMA

NEW 2023

ADULT SIZE

- INCLINED LENSES
- TEXTILE STRAP
- TEMPERED GLASS
- 100% HIGH QUALITY SILICONE SKIRT
- PATENTED ANTI-FOG SYSTEM
- DOUBLE INJECTION TECHNOLOGY



BLACK/BLUE

BLACK/BLACK

CLEAR/AQUAMARINE

CLEAR/BLUE



COLORS	PACK	CODE	DLR €	10%	SEASONAL ORDER 20%	RRP €
BLACK/BLUE	10	DM280520	34.99	31.49	27.99	57.99
BLACK/BLACK	10	DM280550	34.99	31.49	27.99	57.99
CLEAR/AQUAMARINE	10	DM280025	34.99	31.49	27.99	57.99
CLEAR/BLUE	10	DM280020	34.99	31.49	27.99	57.99

# SAMOA + MEXICO

NEW 2023

ADULT SIZE

- TEXTILE STRAP
- TEMPERED GLASS
- 100% HIGH QUALITY SILICONE SKIRT
- PATENTED ANTI-FOG SYSTEM
- DOUBLE INJECTION TECHNOLOGY



BLACK/BLACK

BLACK/AQUAMARINE

CLEAR/BLUE

CLEAR/PINK



COLORS	PACK	CODE	DLR €	10%	SEASONAL ORDER 20%	RRP €
CLEAR/BLUE	10	DM291020	29,99	26,99	23,99	49,99
CLEAR/AQUAMARINE	10	DM291025	29,99	26,99	23,99	49,99
CLEAR/PINK	10	DM291040	29,99	26,99	23,99	49,99
BLACK/BLACK	10	DM291550	29,99	26,99	23,99	49,99

/ SNORKELING COMBOS

# F1 + DRY

NEW 2023

ADULT SIZE



- INCLINED LENSES
- TEXTILE STRAP
- TEMPERED GLASS
- 100% HIGH QUALITY SILICONE SKIRT
- PATENTED ANTI-FOG SYSTEM
- DOUBLE INJECTION TECHNOLOGY



BLUE



CLEAR/SILVER



BLACK



PRODUCT	PACK	CODE	DLR €	10%	SEASONAL ORDER 20%	RRP €
F1 + DRY COMBO BLACK	10	YDS280050	51,25	46,13	40,99	84,99
F1 + DRY COMBO CLEAR	10	YDS280000	51,25	46,13	40,99	84,99
F1 + DRY COMBO BLUE METAL	10	YDS280021	51,25	46,13	40,99	84,99



# METIS + CORSICA HUNTER

NEW 2023

ADULT SIZE

- MICROMETRIC ADJUSTABLE BUCKLE
- TEMPERED GLASS
- 100% HIGH QUALITY SILICONE SKIRT
- FLEXIBLE BUCKLE



CM 24,5X51,5



BLACK/BLUE CAMOU



BLACK CAMOU



GREEN CAMOU

PRODUCT	PACK	CODE	DLR €	10%	SEASONAL ORDER 20%	RRP €
METIS + CORSICA COMBO BLACK HUNTER	10	XDM103051	43,74	39,37	34,99	69,99
METIS + CORSICA COMBO GREEN HUNTER	10	XDM103098	43,74	39,37	34,99	69,99
METIS + CORSICA COMBO BLUE HUNTER	10	XDM103020	43,74	39,37	34,99	69,99

# MAREA + GAMMA

ADULT SIZE



CLEAR/YELLOW

CLEAR/BLUE

CLEAR/PINK



BLUE

LILAC



COLORAMA ASSORTED



BLACK



ASSORTED



COLORS	PACK	CODE	DLR €	10%	SEASONAL ORDER 20%	RRP €
MAREA + GAMMA COMBO CLEAR/YELLOW	10	DM1000051	28.13	25.32	22.50	44.99
MAREA + GAMMA COMBO CLEAR/BLUE	10	DM1000052	28.13	25.32	22.50	44.99
MAREA + GAMMA COMBO CLEAR/PINK	10	DM1000054	28.13	25.32	22.50	44.99
MAREA + GAMMA COMBO BLUE	10	DM1000058	30.63	27.57	24.50	49.99
MAREA + GAMMA COMBO LILAC	10	DM1000057	30.63	27.57	24.50	49.99
MAREA + GAMMA COMBO COLORAMA ASSORTED	10	DM1000059	30.63	27.57	24.50	49.99
MAREA + GAMMA COMBO BLACK	10	DM1000055	28.13	25.32	24.50	44.99
MAREA + GAMMA COMBO ASSORTED COLORS	10	DM100005	28.13	25.32	24.50	44.99



CM 24,5X51,5

# ESTRELLA + GAMMA

ADULT SIZE



CLEAR/BLUE



CLEAR/AQUAMARINE



CLEAR/BLACK



CLEAR/PINK



ASSORTED



CM 24,5X51,5

PRODUCT	PACK	CODE	DLR €	10%	SEASONAL ORDER 20%	RRP €
CLEAR/BLUE	10	DM340020	28,74	25,87	22,99	45,99
CLEAR/AQUAMARINE	10	DM340063	28,74	25,87	22,99	45,99
CLEAR/BLACK	10	DM340050	28,74	25,87	22,99	45,99
CLEAR/PINK	10	DM340040	28,74	25,87	22,99	45,99
ASSORTED	10	DM340099	28,74	25,87	22,99	45,99

# OCEAN + GAMMA

ADULT SIZE



CLEAR/AQUAMARINE



CLEAR/BLACK



BLACK



CM 24,5X51,5

COLORS	PACK	CODE	DLR €	10%	SEASONAL ORDER 20%	RRP €
CLEAR/AQUAMARINE	10	DM1000113	31,88	28,69	25,50	52,99
CLEAR/BLACK	10	DM1000115	31,88	28,69	25,50	52,99
BLACK	10	WDM1000125	31,88	28,69	25,50	52,99
ASSORTED	10	DM100011	31,88	28,69	25,50	52,99



# ONDA + MEXICO

ADULT SIZE



ASSORTED



CLEAR/YELLOW



CLEAR/BLUE



CLEAR/PINK



CLEAR/AQUAMARINE



BLACK



CM 45X15

PRODUCT	PACK	CODE	DLR €	10%	SEASONAL ORDER 20%	RRP €
ASSORTED	10	DM101015	21.24	19.12	16.99	34.99
CLEAR/YELLOW	10	DM1010151	21.24	19.12	16.99	34.99
CLEAR/BLUE	10	DM1010152	21.24	19.12	16.99	34.99
CLEAR/PINK	10	DM1010154	21.24	19.12	16.99	34.99
CLEAR/AQUAMARINE	10	DM1010153	21.24	19.12	16.99	34.99
BLACK	10	DM1010155	21.24	19.12	16.99	34.99

# PERLA + MEXICO

ADULT SIZE



ASSORTED



CLEAR/BLUE



CLEAR/PINK



CLEAR/BLACK



CLEAR/AQUAMARINE



BLACK



CM 45X15

PRODUCT	PACK	CODE	DLR €	10%	SEASONAL ORDER 20%	RRP €
ASSORTED	10	DM101017	18.74	16.87	14.99	29.99
CLEAR/BLUE	10	DM101120	18.74	16.87	14.99	29.99
CLEAR/PINK	10	DM101140	18.74	16.87	14.99	29.99
CLEAR/BLACK	10	DM101150	18.74	16.87	14.99	29.99
CLEAR/AQUAMARINE	10	DM101163	18.74	16.87	14.99	29.99
BLACK	10	DM102017	18.74	16.87	14.99	29.99

# SNORKELING COMBOS JUNIOR





# ESTRELLA JR + TOP

AGE 7-13



BLUE

GREEN

PINK

AQUAMARINE



ASSORTED

PRODUCT	PACK	CODE	DLR €	10%	SEASONAL ORDER 20%	RRP €
ESTRELLA JR TX + TOP COMBO BLUE	10	DM350020	24,99	22,49	19,99	39,99
ESTRELLA JR TX + TOP COMBO GREEN	10	DM350067	24,99	22,49	19,99	39,99
ESTRELLA JR TX + TOP COMBO PINK	10	DM350040	24,99	22,49	19,99	39,99
ESTRELLA JR TX + TOP COMBO AQUAMARINE	10	DM350063	24,99	22,49	19,99	39,99
ESTRELLA JR TX + TOP COMBO ASS. COL.	10	DM351099	24,99	22,49	19,99	39,99

### NEW ELASTICATED FABRIC STRAP



NEW STRAP. EASIER FOR CHILDREN TO PUT ON



SNORKEL LOOP CREATED WITH THE FABRIC STRAP



CM 24,5X51,5



# MAREA JUNIOR + TOP

AGE 7-13



PRODUCT	PACK	CODE	DLR €	10%	SEASONAL ORDER 20%	RRP €
MAREA JR + TOP COMBO YELLOW COLOR	10	DM1000066	23,13	20,82	18,50	39,99
MAREA JR + TOP COMBO BLUE COLOR	10	DM1000068	23,13	20,82	18,50	39,99
MAREA JR + TOP COMBO LILAC COLOR	10	DM1000067	23,13	20,82	18,50	39,99
MAREA JR + TOP COMBO ASSORTED COLORS	10	DM1000069	23,13	20,82	18,50	39,99
MAREA JR + TOP COMBO CLEAR/YELLOW	10	DM1000061	21,88	19,69	17,50	34,99
MAREA JR + TOP COMBO CLEAR/BLUE	10	DM1000062	21,88	19,69	17,50	34,99
MAREA JR + TOP COMBO CLEAR/PINK	10	DM1000064	21,88	19,69	17,50	34,99
MAREA JR + TOP COMBO ASSORTED COLORS	10	DM100006	21,88	19,69	17,50	34,99

# SKY JR + TOP

AGE 7-13



ASSORTED



CM 45X15

PRODUCT	PACK	CODE	DLR €	10%	SEASONAL ORDER 20%	RRP €
ASSORTED	10	DM100200	18,74	16,87	14,99	29,99

# ONDINA JR + TOP

AGE 7-13



CLEAR/YELLOW



CLEAR/BLUE



CLEAR/PINK



CLEAR/AQUAMARINE



CM 45X15

PRODUCT	PACK	CODE	DLR €	10%	SEASONAL ORDER 20%	RRP €
CLEAR/YELLOW	10	DM1010131	20,31	18,28	16,25	32,99
CLEAR/BLUE	10	DM1010132	20,31	18,28	16,25	32,99
CLEAR/PINK	10	DM1010134	20,31	18,28	16,25	32,99
CLEAR/AQUAMARINE	10	DM1010133	20,31	18,28	16,25	32,99
ASSORTED	10	DM101013	20,31	18,28	16,25	32,99

# PERLA JR + MINIGRINGO

AGE 7-13



CLEAR/BLUE



CLEAR/PINK



CLEAR/AQUAMARINE



CLEAR/LIME



ASSORTED



CM 45X15

PRODUCT	PACK	CODE	DLR €	10%	SEASONAL ORDER 20%	RRP €
CLEAR/BLUE	10	DM101220	16,24	14,62	12,99	25,99
CLEAR/PINK	10	DM101240	16,24	14,62	12,99	25,99
CLEAR/AQUAMARINE	10	DM101263	16,24	14,62	12,99	25,99
CLEAR/LIME	10	DM101267	16,24	14,62	12,99	25,99
ASSORTED	10	DM101018	16,24	14,62	12,99	25,99

# MOON + TOP

AGE 5-10



BLUE



LIGHT BLUE/LIME



PINK/LILAC



ASSORTED



CM 45X15

PRODUCT	PACK	CODE	DLR €	10%	SEASONAL ORDER 20%	RRP €
BLUE	10	DM200620	21,88	19,69	17,50	35,99
LIGHT BLUE/LIME	10	DM200720	21,88	19,69	17,50	35,99
PINK/LILAC	10	DM200740	21,88	19,69	17,50	35,99
ASSORTED	10	DM200600	21,88	19,69	17,50	35,99



# SNORKELS



# ITACA ULTRA DRY SPECIALIZED

Retailer-Product

DRY GUARD | PURGE VALVE | 100% HIGH QUALITY SILICONE MOUTHPIECE

## ADULT SIZE

The features at the top end an internationally patented dry guard, which prevents water entry while using it on the surface in any position. The new mechanical device has three movement joints, whose counterweight ensures immediate opening of the upper valve whether you dive or emerge from the water. The lower part is equipped on the inner side with a smooth flexible corrugated section, which keeps the aerator away from the mouth while using any

breathing apparatus. The mouthpiece, made of soft silicone, has an angle studied in a particularly ergonomic way, with a reduced bite size for prolonged use without gum fatigue. The mouthpiece body consists of two pieces, with an inclination that ensures better and faster water drainage. A lower purge valve enables instant clearing when needed. The transparent tube has a side reinforcement in coloured rubber.

### TECHNICAL FEATURES

- Special patented new Aqualstop valve: very efficient on up / down positions
- Dry guard: seals breathing tube when submerged
- Mouthpiece: drops away when not in use - great for scuba divers
- High-quality silicone mouthpiece: is comfortable and durable
- Angled anatomical mouthpiece: reduces jaw fatigue
- Lower purge valve: allows water to be quickly expelled
- Streamlined design reduces drag while swimming
- Adjustable clip for securing to any mask

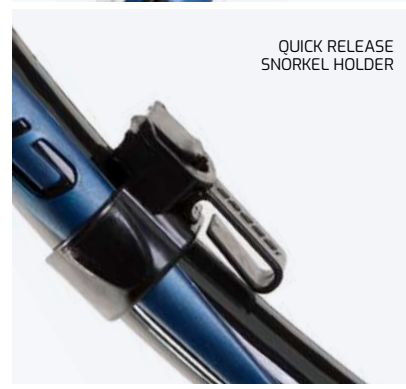
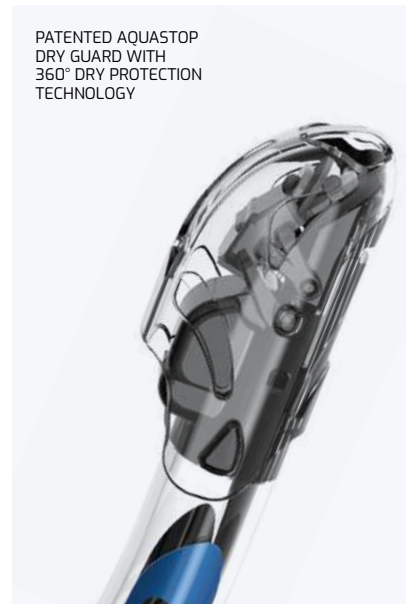

COLORS	PACK	CODE	DLR €	10%	SEASONAL ORDER 20%	RRP €
ITACA ULTRA DRY SNORKEL CLEAR/BLACK	6	ES290050	22.49	20.24	17.99	39.99
ITACA ULTRA DRY SNORKEL CLEAR/RED	6	ES290058	22.49	20.24	17.99	39.99
ITACA ULTRA DRY SNORKEL CLEAR/PINK	6	ES290040	22.49	20.24	17.99	39.99
ITACA ULTRA DRY SNORKEL CLEAR/BLUE METAL	6	ES290020	22.49	20.24	17.99	39.99
ITACA ULTRA DRY SNORKEL BLACK/BLACK	6	ES290150	22.49	20.24	17.99	39.99
ITACA ULTRA DRY SNORKEL BLACK/BLUE METAL	6	ES290120	22.49	20.24	17.99	39.99
ITACA ULTRA DRY SNORKEL BLACK/RED	6	ES290158	22.49	20.24	17.99	39.99
ITACA ULTRA DRY SNORKEL BLACK/GOLD	6	ES290109	22.49	20.24	17.99	39.99
ITACA ULTRA DRY SNORKEL ASSORTED	12	ES290099	22.49	20.24	17.99	39.99

/ SNORKELS

# CORFÙ

## ADULT SIZE

Snorkel designed mainly for snorkeling, apnea and diving. The tube (curved shape and soft material) has a variable section and in the upper part ends with an innovative splash guard, which drastically reduces water entry from waves, without interfering with breathing. The mouthpiece, made of soft silicone, has an angle studied in a particularly ergonomic way, with a reduced bite size for prolonged use without gum fatigue. The mouthpiece body consists of two pieces, with an inclination that ensures better and faster water drainage. A lower purge valve enables instant clearing when needed.

SPLASH GUARD | PURGE VALVE | 100% HIGH QUALITY SILICONE MOUTHPIECE

### TECHNICAL FEATURES

- Profiled splash guard: significantly reduces water entry
- Mouthpiece: drops away when not in use - great for scuba divers
- High-quality silicone mouthpiece: is comfortable and durable
- Angled anatomical mouthpiece: reduces jaw fatigue
- Lower purge valve: allows water to be quickly expelled
- Streamlined design: reduces drag while swimming
- Adjustable clip for securing to any mask



ASSORTED



PROFILED SPLASH GUARD



QUICK RELEASE SNORKEL HOLDER



PURGE VALVE

COLORS	PACK	CODE	DLR €	10%	SEASONAL ORDER 20%	RRP €
CORFU SNORKEL SIL. CLEAR/TUBE SILVER AZURE	6	ES300020	18,13	16,32	14,50	29,99
CORFU SNORKEL SIL. CLEAR/TUBE WHITE LILAC	6	ES300041	18,13	16,32	14,50	29,99
CORFU SNORKEL SIL. CLEAR/TUBE SILVER YELLOW	6	ES300051	18,13	16,32	14,50	29,99
CORFU SNORKEL SIL. CLEAR/TUBE SILVER PINK	6	ES300054	18,13	16,32	14,50	29,99
CORFU SNORKEL SIL. CLEAR/TUBE SILVER BLACK	6	ES300055	18,13	16,32	14,50	29,99
CORFU SNORKEL SIL. BLACK/TUBE BLACK	6	ES300150	18,13	16,32	14,50	29,99
CORFU SNORKEL ASSORTED	12	ES300099	18,13	16,32	14,50	29,99



# ALPHA ULTRA DRY

## ADULT SIZE

Special snorkel with a special patented "Aquistop" valve at the top that keeps water out, making breathing easier and more natural. The tube has an expanded elliptical shape in order to increase comfort and air-delivery capacity. Purge valve and corrugated section near the mouthpiece.

DRY GUARD | PURGE VALVE | 100% HIGH QUALITY SILICONE MOUTHPIECE

### TECHNICAL FEATURES

- Features a float mechanism which closes instantly to prevent water from entering the snorkel whether accidentally or purposely submerged
- Flexible lower bore reduces jaw fatigue
- Mouthpiece drops away when not in use—great for scuba divers
- High-quality silicone mouthpiece is comfortable and durable
- Angled mouthpiece reduces jaw fatigue
- Lower purge valve allows water to be quickly expelled
- Streamlined design reduces drag while swimming
- Adjustable clip for securing to any mask



COLORS	PACK	CODE	DLR €	10%	SEASONAL ORDER 20%	RRP €
ALPHA ULTRA DRY SNORKEL SIL. CLEAR/TUBE BLUE AZURE	6	ES258020	20,63	18,57	16,50	34,99
ALPHA ULTRA DRY SNORKEL SIL. CLEAR/TUBE BLACK SILVER	6	ES258055	20,63	18,57	16,50	34,99
ALPHA ULTRA DRY SNORKEL SIL. CLEAR/TUBE BLACK YELLOW	6	ES258051	20,63	18,57	16,50	34,99
ALPHA ULTRA DRY SNORKEL SIL. CLEAR/TUBE BLACK PINK	6	ES258054	20,63	18,57	16,50	34,99
ALPHA ULTRA DRY SNORKEL SIL. CLEAR/TUBE WHITE LILAC	6	ES258041	20,63	18,57	16,50	34,99
ALPHA ULTRA DRY SNORKEL SIL. BLACK/TUBE BLACK	6	ES258150	20,63	18,57	16,50	34,99
ALPHA ULTRA DRY SNORKEL BLACK/WHITE	6	ES258130	20,63	18,57	16,50	34,99
ALPHA ULTRA DRY SNORKEL BLACK/BLUE	6	ES258062	20,63	18,57	16,50	34,99
ALPHA ULTRA DRY SNORKEL BLACK/YELLOW	6	ES258151	20,63	18,57	16,50	34,99
ALPHA ULTRA DRY SNORKEL SIL./TUBE ASSORTED	12	ES258099	20,63	18,57	16,50	34,99

/ SNORKELS

**DRY** NEW COLOR 2023

**ADULT SIZE**

The dry-top design allows users to take every breath with confidence and focus on the reef below. A float-activated valve instantly seals off the breathing tube if submerged while swimming or from overhead waves. A generous bore provides ample airflow and a lower purge valve enables instant clearing when needed.



- DRY GUARD
- PURGE VALVE
- 100% HIGH QUALITY SILICONE MOUTHPIECE

**TECHNICAL FEATURES**

- Dry-top valve seals breathing tube when submerged
- Flexible lower bore reduces jaw fatigue
- Mouthpiece drops away when not in use great for scuba divers
- High-quality silicone mouthpiece is comfortable and durable
- Angled mouthpiece reduces jaw fatigue
- Lower purge valve allows water to be quickly expelled
- Streamlined design reduces drag while swimming
- Adjustable clip for securing to any mask

DRY GUARD



QUICK RELEASE SNORKEL HOLDER



PURGE VALVE



COLORS	PACK	CODE	DLR €	10%	SEASONAL ORDER 20%	RRP €
DRY SNORKEL CLEAR/YELLOW	6	ES259010	21.88	19.69	17.50	37.99
DRY SNORKEL CLEAR/PINK	6	ES259040	21.88	19.69	17.50	37.99
DRY SNORKEL CLEAR/SILVER	6	ES259060	21.88	19.69	17.50	37.99
DRY SNORKEL CLEAR/LIGHT BLUE	6	ES259062	21.88	19.69	17.50	37.99
DRY SNORKEL BLACK/BLACK	6	ES259550	21.88	19.69	17.50	37.99
DRY SNORKEL BLACK/RED	6	ES259580	21.88	19.69	17.50	37.99
DRY SNORKEL BLACK/BLUE	6	ES259520	21.88	19.69	17.50	37.99
DRY SNORKEL BLACK/YELLOW	6	ES259510	21.88	19.69	17.50	37.99

# GAMMA

## ADULT SIZE

Streamlined and compact, the Gamma is easy to pack for warm water vacations and an excellent choice for divers and snorkelers who appreciate the confidence and cleanliness of using their own equipment. An upper splash guard drastically reduces water entry from waves, and a clever drainage well collects water that does enter so it can be quickly expelled without interfering with breathing.

SPLASH GUARD | PURGE VALVE | 100% HIGH QUALITY SILICONE MOUTHPIECE



COLORS	PACK	CODE	DLR €	10%	SEASONAL ORDER 20%	RRP €
CLEAR/YELLOW	6	EG261010	12,49	11,24	9,99	20,99
CLEAR/BLUE	6	EG261020	12,49	11,24	9,99	20,99
CLEAR/PINK	6	EG261040	12,49	11,24	9,99	20,99
CLEAR/CLEAR	6	EG261060	12,49	11,24	9,99	20,99
CLEAR/AQUAMARINE	6	EG261063	12,49	11,24	9,99	20,99
CLEAR ASSORTED	12	EG261000	12,49	11,24	9,99	20,99
BLACK/BLACK	6	EG261550	12,49	11,24	9,99	20,99

# MEXICO

## ADULT SIZE

The Mexico snorkel is a high-end tube specifically studied to form a perfect fit on any face shape and features a completely rounded progressive profile. The upper baffle reduces water entrance due to waves with a design created to avoid damaging the air inlet flow. It has a transparent tube in a very flexible polyurethane with a mixed matte-gloss texture. The section of the tube walls is studied to maintain the necessary stiffness in the pressure zone of the mask strip to support air circulation in this area. It has a very comfortable mouthpiece with a design that combines different thicknesses to favor its self-orientation and relieve the tension of the user's jaw after long use. T

SPLASH GUARD | 100% HIGH QUALITY SILICONE MOUTHPIECE

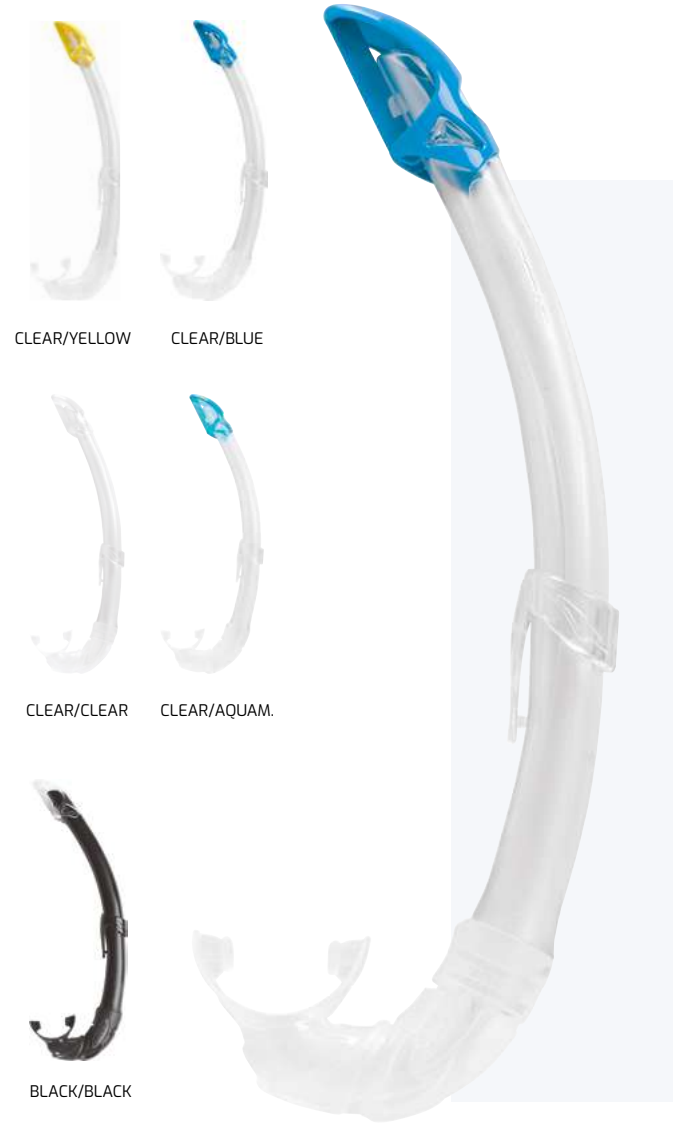

COLORS	PACK	CODE	DLR €	10%	SEASONAL ORDER 20%	RRP €
CLEAR/YELLOW	6	EG269010	7,19	6,47	5,75	12,99
CLEAR/BLUE	6	EG269020	7,19	6,47	5,75	12,99
CLEAR/CLEAR	6	EG269060	7,19	6,47	5,75	12,99
CLEAR/AQUAMARINE	6	EG269063	7,19	6,47	5,75	12,99
BLACK/BLACK	6	EG269550	7,19	6,47	5,75	12,99
ASSORTED	12	EG269000	7,19	6,47	5,75	12,99



# CORSICA

## ADULT SIZE

CORSICA is a highly technical snorkel designed specifically for deep freediving and spearfishing. The soft bendable large diameter tubing makes it extremely comfortable to properly position behind the head while maintaining ease of breathing on the surface. When diving, the mouthpiece tucks neatly under the chin for the ultimate in hydrodynamics.

The anatomical hypoallergenic silicone mouthpiece provides extreme comfort during long durations in the water. The CORSICA is available in either black or green and is an excellent choice for the discriminating diver who is looking for the best equipment.

100% HIGH QUALITY SILICONE MOUTHPIECE

ULTRA FLEX MATERIAL

### TECHNICAL FEATURES

- Anatomical hypoallergenic silicone mouthpiece provides extreme comfort during prolonged use
- Soft bendable snorkel tube to maintain proper and comfortable positioning
- Large diameter snorkel tube provides unobstructed ease of breathing
- Specially designed and molded u-bend provides easier clearing capability
- Ultra flexible tube



BLACK/BLACK

BLACK/GREEN



BLUE METAL

WHITE

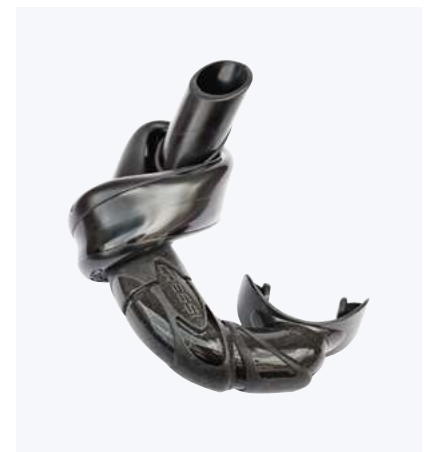
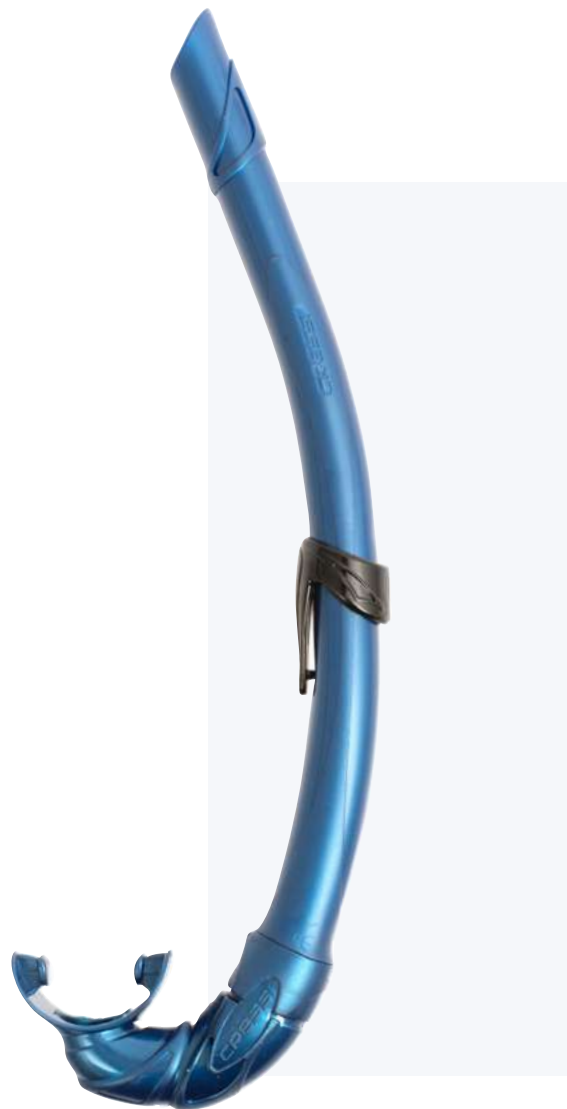

COLORS	PACK	CODE	DLR €	10%	SEASONAL ORDER 20%	RRP €
BLACK/BLACK	12	EG268550	13.74	12.37	10.99	22.99
BLACK/GREEN	12	EG268598	13.74	12.37	10.99	22.99
BLUE METAL	12	EG268555	13.74	12.37	10.99	22.99
WHITE	12	EG268530	13.74	12.37	10.99	22.99

# AMERICA

## ADULT SIZE

AMERICA is a snorkel specifically designed for deep freediving and spearfishing. This snorkel provides excellent surface breathing properties due to its shorter, large bore flexible tubing with minimal curves to maintain a proper position around the head. The multi-positional soft silicone swivel mouthpiece can be tuned at any angle to provide extreme comfort during long durations in the water.

### TECHNICAL FEATURES

- The multi-positional silicone soft mouthpiece provides extreme comfort during prolonged use
- Large diameter Snorkel Tube provides unobstructed ease of breathing
- Minimal tube and mouthpiece bends provides easier clearing capability



COLORS	PACK	CODE	DLR €	10%	SEASONAL ORDER 20%	RRP €
BLACK/BLACK	12	EG267050	9,99	8,99	7,99	17,99

# GRINGO

## ADULT SIZE

GRINGO is a traditional snorkel used for all types of diving. This snorkel provides excellent surface breathing properties due to its fairly straight tubing with minimal curves to maintain a proper position around the head. The multi-positional soft silicone swivel mouthpiece can be tuned at any angle to provide extreme comfort during long durations in the water.

### TECHNICAL FEATURES

- The multi-positional silicone soft mouthpiece provides extreme comfort during prolonged use
- Large diameter Snorkel Tube provides unobstructed ease of breathing
- Minimal tube and mouthpiece bends provides easier clearing capability



COLORS	PACK	CODE	DLR €	10%	SEASONAL ORDER 20%	RRP €
BLACK/BLACK	12	EG266000	5,63	5,07	4,50	9,99



# SNORKELS JUNIOR



# MINIDRY

NEW COLOR 2023

DRY GUARD PURGE VALVE

## SMALL SIZE

Version of the Dry model for women and children. The MiniDry snorkel has an original anti-splash end with a special valve that seals the tube as you dive, almost totally preventing the entrance of water as the snorkel is submerged. The lower end has a corrugated part that is smooth on the

inside and keeps the snorkel away from the mouth when using breathing apparatus. A special water collection cup, with a large elliptic discharge valve makes expelling water quick and easy.

### TECHNICAL FEATURES

- Anti-splash end with automatically closing valve
- Ergonomic shape for maximum comfort
- Mouthpiece and corrugated part in hypoallergenic silicone
- Discharge cup for easy and quick emptying



COLORS	PACK	CODE	DLR €	10%	SEASONAL ORDER 20%	RRP €
MINIDRY SNORKEL SIL. CLEAR/TUBE PINK	12	ES258840	14.06	12.65	11.25	22.99
MINIDRY SNORKEL SIL. CLEAR/TUBE YELLOW	12	ES258810	14.06	12.65	11.25	22.99
MINIDRY SNORKEL SIL. CLEAR/TUBE BLUE	12	ES258820	14.06	12.65	11.25	22.99
MINIDRY SNORKEL SIL. CLEAR/TUBE SILVER	12	ES258960	14.06	12.65	11.25	22.99
MINIDRY SNORKEL SIL. CLEAR/TUBE FLUO GREEN	12	XES258998	14.06	12.65	11.25	22.99
MINIDRY SNORKEL SIL. CLEAR/TUBE ORANGE	12	XES258985	14.06	12.65	11.25	22.99

# TOP

## SMALL SIZE

Sized for optimal comfort and performance for kids, the Top uses the same quality materials as adult snorkels. A splash guard helps reduce water entry and a purge valve below the mouthpiece makes for effortless clearing. The fully adjustable snorkel keeper allows for perfect positioning.

### TECHNICAL FEATURES

- Smaller size for young explorers
- Splash guard helps minimize water entry from splashing or waves
- High-quality silicone mouthpiece is comfortable and durable
- Angled mouthpiece reduces jaw fatigue
- Lower purge valve allows water to be quickly expelled
- Adjustable clip for securing to any mask



COLORS	PACK	CODE	DLR €	10%	SEASONAL ORDER 20%	RRP €
BLUE	6	ES269120	8,13	7,32	6,50	12,99
PINK	6	ES269140	8,13	7,32	6,50	12,99
CLEAR/YELLOW	6	ES269010	8,13	7,32	6,50	12,99
CLEAR/AQUAMARINE	6	ES269063	8,13	7,32	6,50	12,99
CLEAR ASSORTED	12	ES269099	8,13	7,32	6,50	12,99

# MINIGRINGO

## KID SIZE

Smaller version of the Gringo adult snorkel designed for youth boys and girls. The Mini-Gringo is a traditional snorkel for snorkeling and swimming. Flexible, standard bore tube, complete with sliding elastic clip to attach it to the mask. The multi-positional silicone soft mouthpiece provides extreme comfort during prolonged use. Large diameter snorkel tube provides unobstructed ease of breathing. Minimal tube and mouthpiece bends provides easier clearing capability.

### TECHNICAL FEATURES

- Standard bore tube
- Keeper: sliding elastic clip
- Multi-positional silicon mouthpiece
- Lightweight



COLORS	PACK	CODE	DLR €	10%	SEASONAL ORDER 20%	RRP €
CLEAR/CLEAR	12	EG265500	4,81	4,33	3,85	9,99

/ SNORKELS SPARE PARTS

**SNORKEL KEEPER**

BLACK - FOR GRINGO SNORKEL



CODE	DLR €	10%	SEASONAL ORDER 20%	RRP €
EZ260003	2.49	2.24	1.99	3.99

**SNORKEL KEEPER**

FOR AMERICA SNORKEL



CODE	DLR €	10%	SEASONAL ORDER 20%	RRP €
EZ267004	2.49	2.24	1.99	3.99

**SNORKEL KEEPER**

DARK - FOR MEXICO/CORSICA SNORKELS



CODE	DLR €	10%	SEASONAL ORDER 20%	RRP €
EZ267005	2.49	2.24	1.99	3.99

**SNORKEL KEEPER**

CLEAR - FOR GAMMA SNORKEL



CODE	DLR €	10%	SEASONAL ORDER 20%	RRP €
EZ267009	2.49	2.24	1.99	3.99

**SNORKEL KEEPER**

FOR TOP SNORKEL



CODE	DLR €	10%	SEASONAL ORDER 20%	RRP €
EZ267011	2.49	2.24	1.99	3.99

**SNORKEL KEEPER**

FOR ALPHA ULTRA DRY/ITACA/CORFU SNORKELS



CODE	DLR €	10%	SEASONAL ORDER 20%	RRP €
EZ267015	3.74	3.37	2.99	3.99

**SNORKEL KEEPER**

FOR DRY/TAO SNORKELS



CODE	DLR €	10%	SEASONAL ORDER 20%	RRP €
EZ267018	3.74	3.37	2.99	3.99

**SNORKEL KEEPER**

FOR MINIDRY SNORKEL



CODE	DLR €	10%	SEASONAL ORDER 20%	RRP €
EZ267019	3.13	2.82	2.50	4.99



# SWIMMING GOGGLES





# SKYLIGHT

U.S. PAT 5.956.778 | TOTAL VISION | MICROMETRIC ADJUSTABLE BUCKLE | 100% ANTI UV LENS | ANTI SCRATCH LENS | ANTI FOG LENS

## ADULT SIZE | 180 DEGREES WIDE VIEW SWIM GOGGLES

70 years of mask designs and today's advanced technology comes together in this Cressi masterpiece. We are proud to introduce the best open ocean goggle in the market. It is not only for the serious swimmer. The Skylight has the very best fit

for hours and with wide vision to keep track of the directions which is actually what every swimmer would like to get out of a goggle. If your customers needs the very best goggle in the market, this is what you should get them.

### TECHNICAL FEATURES

- Material** 100% Silicone
- Leak proof skirt for a universal fit
  - Perfect for open water and recreational swimming

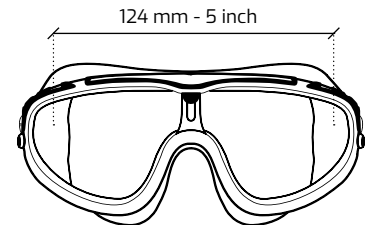

### REGULAR



### MIRRORED



COLOR	CODE	PACK	DLR €	10%	SEASONAL ORDER 20%	RRP €
CLEAR/FRAME BLACK BLUE	DE203320	6	20.31	18.28	16.25	37.99
CLEAR/FRAME WHITE PINK	DE203340	6	20.31	18.28	16.25	37.99
CLEAR/FRAME BLACK LIME	DE203367	6	20.31	18.28	16.25	37.99
CLEAR/FRAME WHITE BLUE	DE203322	6	20.31	18.28	16.25	37.99
CLEAR/FRAME WHITE BLACK	DE203350	6	20.31	18.28	16.25	37.99
SIL/FRAME ASSORTED	DE203399	12	20.31	18.28	16.25	37.99
BLUE METAL	DE2033555	6	20.31	18.28	16.25	37.99
BLACK/FRAME BLACK SMOKED LENS	DE203450	6	20.31	18.28	16.25	37.99
BLACK/FRAME BLACK LIME	DE203467	6	20.31	18.28	16.25	37.99
BLACK/FRAME WHITE BLACK	DE203451	6	20.31	18.28	16.25	37.99
CLEAR/FRAME BLACK GREY MIRRORED LENS	DE2033750	6	23.74	21.37	18.99	39.99
BLACK/FRAME BLACK GREY MIRRORED LENS	DE2034750	6	23.74	21.37	18.99	39.99



REUSABLE PROTECTIVE BOX 13.5X21 CM

# PLANET

## ADULT SIZE

Goggles with facial soft silicone which ensures perfect adaptability to a wide range of facial profiles Ideal for swimming, swimming, triathlon and water sports for all Good face seal and great comfort, shatterproof lenses with UV protection and scratch-resistant external

treatment internal anti-fog treatment and extra strong Interchangeable strap instantly with patented buckles with micrometric adjustment and immediate, similar to those of the Cressi-sub diving masks Wide range of colors Special packaging to preserve its characteristics over time.

- U.S. PAT 5.956.778
- TOTAL VISION
- MICROMETRIC ADJUSTABLE BUCKLE
- 100% ANTI UV LENS
- ANTI SCRATCH LENS
- ANTI FOG LENS

### TECHNICAL FEATURES

- Material** 100% Silicone
- Leak proof skirt for a universal fit
  - Perfect for open water and recreational swimming

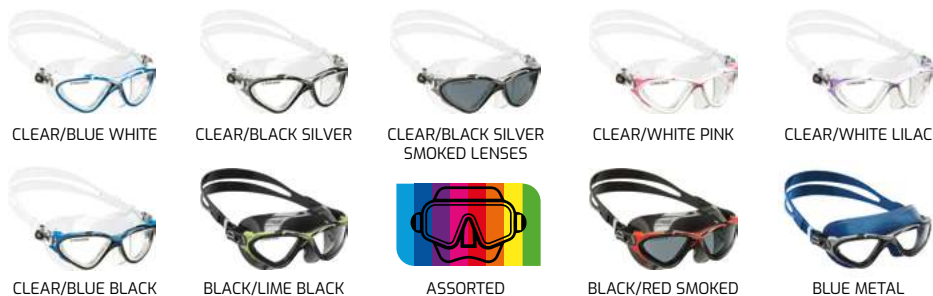
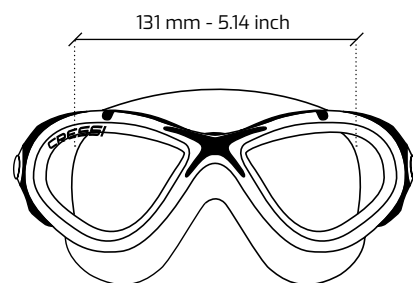

COLOR	CODE	PACK	DLR €	10%	SEASONAL ORDER 20%	RRP €
CLEAR/FRAME BLUE WHITE	DE202620	6	18.74	16.87	14.99	31.99
CLEAR/FRAME BLACK SILVER	DE202650	6	18.74	16.87	14.99	31.99
CLEAR/FRAME BLACK SILVER SMOKED LENS	DE202651	6	18.74	16.87	14.99	31.99
CLEAR/FRAME WHITE PINK	DE202640	6	18.74	16.87	14.99	31.99
CLEAR/FRAME WHITE LILAC	DE202641	6	18.74	16.87	14.99	31.99
CLEAR/FRAME BLUE BLACK	DE202722	6	18.74	16.87	14.99	31.99
BLACK/FRAME LIME BLACK	DE202767	6	18.74	16.87	14.99	31.99
SIL/FRAME ASSORTED	DE202699	12	18.74	16.87	14.99	31.99
BLACK/FRAME RED SMOKED LENS	DE202758	6	18.74	16.87	14.99	31.99
BLUE METAL	DE2026555	6	18.74	16.87	14.99	31.99





# COBRA

## ADULT SIZE

Goggles with a single-piece skirt that is characterised by the presence of an elastic element within the structure that allows a perfect fit on most facial profiles. Shatterproof lenses with anti-scratch treatment, UV protection and internal

anti-fog treatment. Indestructible, micrometrically adjustable buckles. Possibility of instantly replacing the buckle-strap structure with other models from the Cressi range. Special packaging maintains these characteristics over time.

- U.S. PAT 5.956.778
- TOTAL VISION
- MICROMETRIC ADJUSTABLE BUCKLE
- ULTRA CLEAR VISION
- 100% ANTI UV LENS
- ANTI SCRATCH LENS
- ANTI FOG LENS



### TECHNICAL FEATURES

- Material** 100% Premium TPR
- Leak proof skirt for a universal fit
  - Perfect for open water and recreational swimming

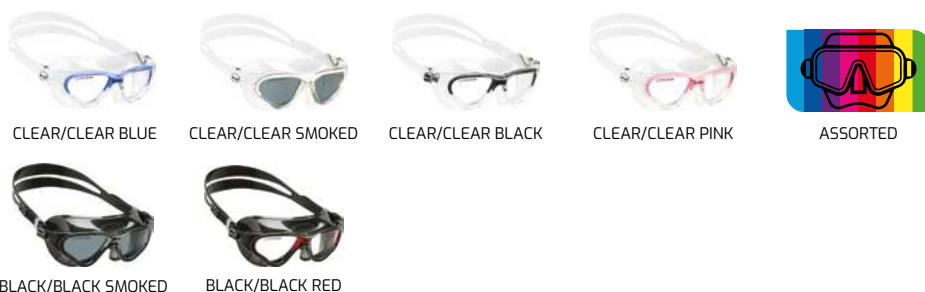
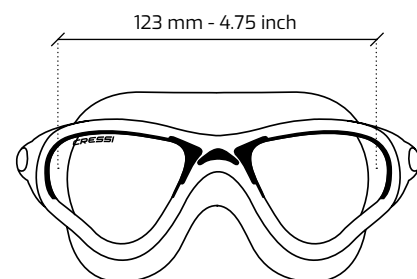

COLOR	CODE	PACK	DLR €	10%	SEASONAL ORDER 20%	RRP €
CLEAR/FRAME CLEAR BLUE	DE201922	6	14,99	13,49	11,99	25,99
CLEAR/FRAME CLEAR WHITE SMOKED LENS	DE201931	6	14,99	13,49	11,99	25,99
CLEAR/FRAME CLEAR BLACK	DE201950	6	14,99	13,49	11,99	25,99
CLEAR/FRAME CLEAR PINK	DE201940	6	14,99	13,49	11,99	25,99
ASSORTED	DE201999	12	14,99	13,49	11,99	25,99
BLACK/FRAME BLACK SMOKED LENS	DE201992	6	14,99	13,49	11,99	25,99
BLACK/FRAME BLACK RED	DE201991	6	14,99	13,49	11,99	25,99



100%  
SOFT SILICONE



MADE IN  
ITALY

U.S. PAT  
5.956.778

MICROMETRIC  
ADJUSTABLE BUCKLE

100% ANTI  
UV LENS

ANTI  
SCRATCH LENS

ANTI  
FOG LENS

# GALILEO

## ADULT SIZE | WITH TEMPERED GLASS LENSES

The Galileo goggles have marked a historical turning point in the swimming goggles sector. In actual fact, their flat lenses are mounted on a rigid frame, just like a diving mask, thus guaranteeing perfect vision with no distortion. The shape of the lenses, which are perfectly flat and have no side curving, also prevents annoying distortion at the sides of the lenses.

The watertight seal is extraordinary and comfort is excellent. The strap has a quick adjustment system (Cressi patented), similar to that used on the prestigious Cressi-sub masks, which allows quick and easy adjustment. The shatterproof lenses have external anti-scratch treatment, UV protection and internal anti-fog treatment.



AQUAMARINA



DARK



BLUE METAL



WHITE

COLOR	CODE	PACK	DLR €	10%	SEASONAL ORDER 20%	RRP €
T/GLASS SIL/FRAME AQUAMARINA	DE205599	6	21,88	19,69	17,50	37,99
T/GLASS DARK	DE205050	6	21,88	19,69	17,50	37,99
T/GLASS BLUE METAL	DE205055	6	21,88	19,69	17,50	37,99
T/GLASS WHITE	DE205030	6	21,88	19,69	17,50	37,99



REUSABLE PROTECTIVE BOX  
13.5X21 CM

# THUNDER

## ADULT SIZE | ADVANCED SWIMMER

Swim goggles with separated eyepieces, characterized by an elastic element in the structure that allows the perfect adaptability to most of facial profiles, equipped with slightly curved

lenses on the external side to give the best view. Shatter-proof lenses with anti-scratch treatment, UV rays protection and anti-fog inner treatment. Indestructible clasps with micrometer adjustment.

- U.S. PAT 5.956.778
- TOTAL VISION
- MICROMETRIC ADJUSTABLE BUCKLE
- INCLINED 18° LENSES
- ULTRA CLEAR SKIRT
- 100% ANTI UV LENS
- ANTI SCRATCH LENS
- ANTI FOG LENS



COLOR	CODE	PACK	DLR €	10%	SEASONAL ORDER 20%	RRP €
THUNDER GOGGLES BLUE	DE203520	6	17,49	15,74	13,99	29,99
THUNDER GOGGLES ORANGE	DE203585	6	17,49	15,74	13,99	29,99
THUNDER GOGGLES LIME	DE203567	6	17,49	15,74	13,99	29,99
THUNDER GOGGLES BLACK/BLACK	DE203650	6	17,49	15,74	13,99	29,99
THUNDER GOGGLES WHITE/BLUE	DE203519	6	17,49	15,74	13,99	29,99
THUNDER GOGGLES BLACK/BLACK MIRRORED	DE2036750	6	17,49	15,74	13,99	29,99
THUNDER GOGGLES ASSORTED	DE203599	12	17,49	15,74	13,99	29,99

### TECHNICAL FEATURES

- Material** 100% Premium TPR
- Leak proof skirt for a universal fit
  - Perfect for open water and recreational swimming
  - Flexible nose bridge fits various facial profiles



**NOSE BRIDGE:**  
Flexible nose bridge fits various facial profiles



**EASY ADJUSTABLE BUCKLES**

**BUCKLES:**  
Indestructible buckles, with micrometer system adjustment patented by Cressi. Easy to wear

**U.S. PAT 5.956.778**  
Device for regulating the length of a swimming goggles strap



**STRAP:**  
100% High quality silicone



**REUSABLE PROTECTIVE BOX**  
13.5X21 CM



# FLASH

## ADULT SIZE COMFORTABLE & PERFORMANCE

Flash goggles are characterized by the presence of an elastic element within the structure which allows for perfect adaptability to a large number of facial profiles. Lenses are slightly curved on the outer profile, offering maximum visibility.

Shatterproof lenses with scratchproof treatment and UV protection, as well as internal anti-fogging treatment. Indestructible, micrometrically adjustable buckles. Possibility of instantly replacing the buckle-strap structure with other models from the Cressi range.

### FEATURES & SIZE CHARTS

**Material** 100% Premium TPR

- Leak proof skirt for a universal fit
- Perfect for open water and recreational swimming
- Flexible nose bridge fits various facial profiles

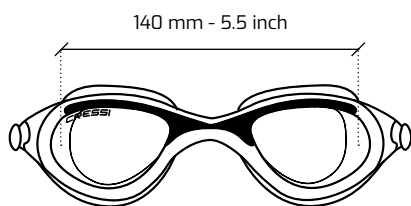

U.S. PAT  
5.956.778

TOTAL  
VISION

MICROMETRIC  
ADJUSTABLE BUCKLE

ULTRA CLEAR  
SKIRT

INCLINED  
18° LENSES

100% ANTI  
UV LENS

ANTI  
SCRATCH LENS

ANTI  
FOG LENS



### REGULAR



### MIRRORED



PRODUCT	CODE	PACK	DLR €	10%	SEASONAL ORDER 20%	RRP €
FLASH GOGGLES CLEAR/FRAME CLEAR BLUE	DE202322	6	14.38	12.94	11.50	25.99
FLASH GOGGLES CLEAR/FRAME CLEAR BLUE AZURE LENS	DE202323	6	14.38	12.94	11.50	25.99
FLASH GOGGLES CLEAR/FRAME CLEAR WHITE SMOKED LENS	DE202331	6	14.38	12.94	11.50	25.99
FLASH GOGGLES CLEAR/FRAME CLEAR RED	DE202358	6	14.38	12.94	11.50	25.99
FLASH GOGGLES CLEAR/FRAME CLEAR BLACK	DE202350	6	14.38	12.94	11.50	25.99
FLASH GOGGLES ASSORTED	DE202399	12	14.38	12.94	11.50	25.99
FLASH GOGGLES BLUE/FRAME BLUE WHITE	DE202320	6	14.38	12.94	11.50	25.99
FLASH GOGGLES BLACK/FRAME BLACK GREY SMOKED LENS	DE202392	6	14.38	12.94	11.50	25.99
FLASH GOGGLES BLACK/FRAME BLACK RED	DE202391	6	14.38	12.94	11.50	25.99
FLASH GOGGLES CLEAR/FRAME CLEAR GREEN MIRRORED LENS	DE2023757	6	16.24	14.62	12.99	29.99
FLASH GOGGLES CLEAR/FRAME CLEAR BLUE MIRRORED LENS	DE2023752	6	16.24	14.62	12.99	29.99

# FLASH LADY

**ADULT SIZE**  
**COMFORTABLE & PERFORMANCE**

U.S. PAT  
5.956.778

TOTAL  
VISION

MICROMETRIC  
ADJUSTABLE BUCKLE

ULTRA CLEAR  
SKIRT

INCLINED  
18° LENSES

100% ANTI  
UV LENS

ANTI  
SCRATCH LENS

ANTI  
FOG LENS



### FEATURES & SIZE CHARTS

- Material** 100% Premium TPR
- Leak proof skirt for a universal fit
  - Perfect for open water and recreational swimming
  - Flexible nose bridge fits various facial profiles

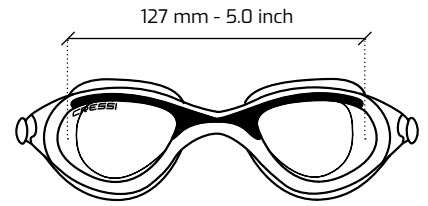

### REGULAR



PRODUCT	CODE	PACK	DLR €	10%	SEASONAL ORDER 20%	RRP €
FLASH LADY GOGGLES CLEAR/FRAME CLEAR BLUE	DE203020	6	14.38	12.94	11.50	25.99
FLASH LADY GOGGLES CLEAR/FRAME CLEAR BLACK	DE203050	6	14.38	12.94	11.50	25.99
FLASH LADY GOGGLES CLEAR/FRAME CLEAR WHITE SMOKED LENS	DE203031	6	14.38	12.94	11.50	25.99
FLASH LADY GOGGLES CLEAR/FRAME CLEAR LILAC	DE203041	6	14.38	12.94	11.50	25.99
FLASH LADY GOGGLES CLEAR/FRAME CLEAR PINK	DE203040	6	14.38	12.94	11.50	25.99
FLASH LADY GOGGLES ASSORTED	DE203099	12	14.38	12.94	11.50	25.99
FLASH LADY GOGGLES BLACK/FRAME BLACK GREY SMOKED LENS	DE202950	6	14.38	12.94	11.50	25.99



/ SWIMMING GOGGLES

# RIGHT

## ADULT SIZE

U.S. PAT  
5.956.778

MICROMETRIC  
ADJUSTABLE BUCKLE

100% ANTI  
UV LENS

ANTI  
SCRATCH LENS

ANTI  
FOG LENS

The Right Goggles feature a classic round lens shape. The lenses are also slightly curved which provides excellent peripheral vision. The TPR gaskets around the lenses form a comfortable, watertight seal around the eye socket. The lenses feature external anti-scratch treatment, UV

protection and internal anti-fog treatment. The headband is made of 100% hypoallergenic silicone for maximum comfort and fit. The strap and buckle is also interchangeable with all other goggles and masks in the Cressi Swim Line.

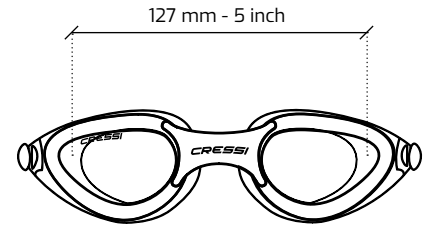

ASSORTED



BLUE/BLUE



CLEAR/CLEAR



BLUE METAL



CLEAR/CLEAR AZURE LENS



BLACK/BLACK

PRODUCT	CODE	PACK	DLR €	10%	SEASONAL ORDER 20%	RRP €
RIGHT GOGGLES BLUE/FRAME BLUE	DE201621	6	12,49	11,24	9,99	19,99
RIGHT GOGGLES CLEAR/FRAME CLEAR	DE201660	6	12,49	11,24	9,99	19,99
RIGHT GOGGLES BLUE METAL	DE2016555	6	12,49	11,24	9,99	19,99
RIGHT GOGGLES CLEAR/FRAME CLEAR AZURE LENS	DE201663	6	12,49	11,24	9,99	19,99
RIGHT GOGGLES BLACK/FRAME BLACK	DE201650	6	12,49	11,24	9,99	19,99
RIGHT GOGGLES ASSORTED	DE201699	12	12,49	11,24	9,99	19,99





# FOX

## ADULT SIZE

The sophisticated design of the Fox Goggles feature uniquely shaped flat lenses which combine fashionable style with perfect vision underwater. The lenses are shatterproof and feature external anti-scratch treatment, UV protection and internal anti-fog treatment.

The Fox goggles feature comfortable TPR gaskets which form a watertight seal on the eyes and fit most facial profiles. The silicone strap and micro-adjustable buckle system are interchangeable with all the other masks and goggles in the Cressi Swim Line.

- U.S. PAT  
5.956.778
- MICROMETRIC  
ADJUSTABLE BUCKLE
- 100% ANTI  
UV LENS
- ANTI  
SCRATCH LENS
- ANTI  
FOG LENS

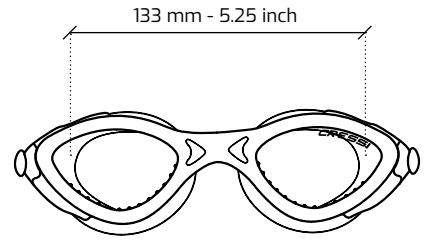

CLEAR



AQUAMARINE



BLACK



ASSORTED

PRODUCT	CODE	PACK	DLR €	10%	SEASONAL ORDER 20%	RRP €
FOX GOGGLES CLEAR/FRAME CLEAR	DE202160	6	12,49	11,24	9,99	19,99
FOX GOGGLES ACQUAMARINA/FRAME AQUAMARINE	DE202163	6	12,49	11,24	9,99	19,99
FOX GOGGLES BLACK/FRAME BLACK	DE202150	6	12,49	11,24	9,99	19,99
FOX GOGGLES ASSORTED	DE202199	12	12,49	11,24	9,99	19,99











# MINI COBRA

## JUNIOR'S SWIM MASK 7-15 YEARS

U.S. PAT 5.956.778 | TOTAL VISION | MICROMETRIC ADJUSTABLE BUCKLE | ULTRA CLEAR SKIRT | 100% ANTI UV LENS | ANTI SCRATCH LENS | ANTI FOG LENS | 7-15 YEARS

Goggles with a single-piece skirt that is characterised by the presence of an elastic element within the structure that allows a perfect fit on most facial profiles. Shatterproof lenses with anti-scratch treatment, UV protection and internal

anti-fog treatment. Indestructible, micrometrically adjustable buckles. Possibility of instantly replacing the buckle-strap structure with other models from the Cressi range. Special packaging maintains these characteristics over time.

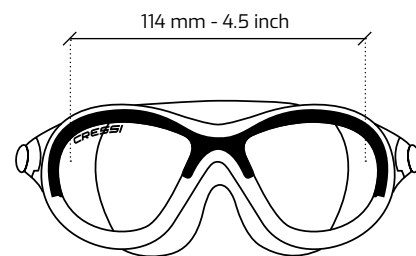

ASSORTED



PRODUCT	CODE	PACK	DLR €	10%	SEASONAL ORDER 20%	RRP €
MINI COBRA GOGGLES CLEAR/FRAME LIME	DE202067	6	14.38	12.94	11.50	24.99
MINI COBRA GOGGLES CLEAR/FRAME BLUE	DE202022	6	14.38	12.94	11.50	24.99
MINI COBRA GOGGLES CLEAR/FRAME PINK	DE202040	6	14.38	12.94	11.50	24.99
MINI COBRA GOGGLES LIGHT BLUE/FRAME LIME	DE202021	6	14.38	12.94	11.50	24.99
MINI COBRA GOGGLES CLEAR/FRAME BLUE AZURE LENS	DE202023	6	14.38	12.94	11.50	24.99
MINI COBRA GOGGLES ASSORTED	DE202000	12	14.38	12.94	11.50	24.99

# KING BALOO NEW 2023

U.S. PAT 5.956.778 | TOTAL VISION | MICROMETRIC ADJUSTABLE BUCKLE | ULTRA CLEAR SKIRT | 100% ANTI UV LENS | ANTI SCRATCH LENS | ANTI FOG LENS | 7 - 15 YEARS

## JUNIOR'S SWIM MASK 7-15 YEARS

This SMALL-SIZE glass mono goggle is designed for teens in order to allow any activity, also play, while maintaining excellent watertightness. The reduced skirt of its structure improves stability on the face as well as grip capacity.

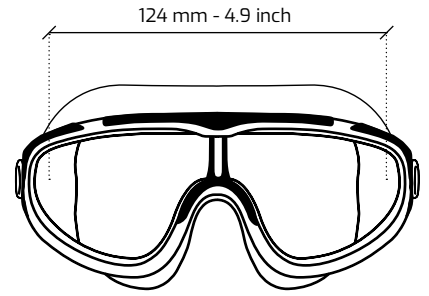

PRODUCT	CODE	PACK	DLR €	10%	SEASONAL ORDER 20%	RRP €
KING BALOO KID GOGGLES BLUE/FRAME WHITE	DE203720	6	16,24	14,62	12,99	27,99
KING BALOO KID GOGGLES AQUAMARINE/FRAME BLUE WHITE	DE203725	6	16,24	14,62	12,99	27,99
KING BALOO KID GOGGLES PINK/FRAME WHITE	DE203740	6	16,24	14,62	12,99	27,99
KING BALOO KID GOGGLES LILAC/FRAME WHITE	DE203741	6	16,24	14,62	12,99	27,99

# BALOO

## KID'S SWIM MASK 2-7 YEARS

This SMALL-SIZE glass mono goggle is designed for children in order to allow any activity, also play, while maintaining excellent watertightness. The reduced skirt of its structure improves stability on the face as well as grip capacity.

- U.S. PAT 5.956.778
- TOTAL VISION
- MICROMETRIC ADJUSTABLE BUCKLE
- ULTRA CLEAR SKIRT
- 100% ANTI UV LENS
- ANTI SCRATCH LENS
- ANTI FOG LENS
- 2-7 YEARS

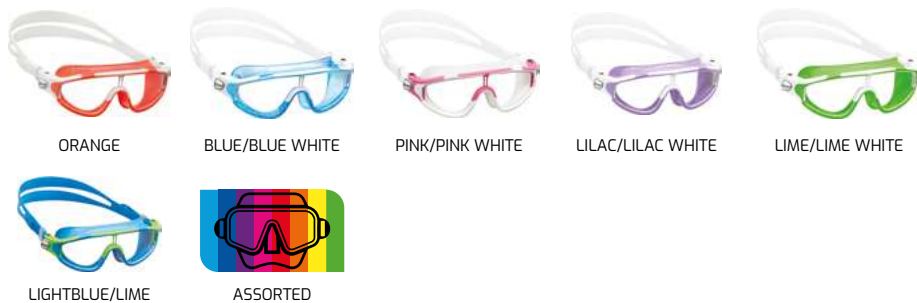
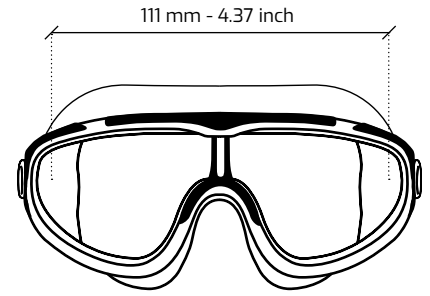

PRODUCT	CODE	PACK	DLR €	10%	SEASONAL ORDER 20%	RRP €
BALOO KID GOGGLES ORANGE	DE203285	6	13,74	12,37	10,99	22,99
BALOO KID GOGGLES BLUE/FRAME BLUE WHITE	DE203220	6	13,74	12,37	10,99	22,99
BALOO KID GOGGLES PINK/FRAME PINK WHITE	DE203240	6	13,74	12,37	10,99	22,99
BALOO KID GOGGLES LILAC/FRAME LILAC WHITE	DE203241	6	13,74	12,37	10,99	22,99
BALOO KID GOGGLES LIME/FRAME LIME WHITE	DE203267	6	13,74	12,37	10,99	22,99
BALOO KID GOGGLES LIGHT BLUE/LIME	DE203222	6	13,74	12,37	10,99	22,99
BALOO KID GOGGLES ASSORTED	DE203299	12	13,74	12,37	10,99	22,99





U.S. PAT  
5.956.778

MICROMETRIC  
ADJUSTABLE BUCKLE

100% ANTI  
UV LENS

ANTI  
SCRATCH LENS

ANTI  
FOG LENS

7 - 15  
YEARS

# ROCKS

## JUNIOR'S SWIM MASK 7-15 YEARS

Cressi Rocks are prestigious goggles with slightly curved lenses on the outer profile, to offer maximum visibility. Cressi advanced technology for excellent sealing on most face shapes. Instantly interchangeable strap with patented, immediate,

micrometrically adjustable buckles just like those on the Cressi-sub diving masks. Lenses with external anti-scratch treatment, UV protection and internal anti-fog treatment.

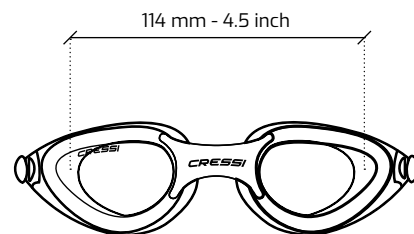

BLUE/BLUE



CLEAR



WHITE/WHITE BLUE



ASSORTED



PRODUCT	CODE	PACK	DLR €	10%	SEASONAL ORDER 20%	RRP €
ROCKS KID GOGGLES BLUE/FRAME BLUE	DE201321	6	13,13	11,82	10,50	21,99
ROCKS KID GOGGLES CLEAR	DE201360	6	13,13	11,82	10,50	21,99
ROCKS KID GOGGLES WHITE/FRAME WHITE BLUE	DE201332	6	13,13	11,82	10,50	21,99
ROCKS KID GOGGLES ASSORTED	DE201399	12	13,13	11,82	10,50	21,99

# KING CRAB

## JUNIOR'S SWIM MASK 7-15 YEARS

U.S. PAT 5.956.778 | MICROMETRIC ADJUSTABLE BUCKLE | 100% ANTI UV LENS | ANTI SCRATCH LENS | ANTI FOG LENS | 7-15 YEARS

The sophisticated design of the King Crab Goggles feature uniquely shaped flat lenses which combine fashionable style with perfect vision underwater. The lenses are shatterproof and feature external anti-scratch treatment, UV protection and internal anti-fog treatment.

The King Crab goggles feature comfortable TPR gaskets which form a watertight seal on the eyes and fit most facial profiles. The silicone strap and micro-adjustable buckle system are interchangeable with all the other masks and goggles in the Cressi Swim Line.

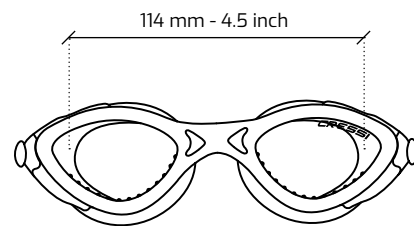

PRODUCT	CODE	PACK	DLR €	10%	SEASONAL ORDER 20%	RRP €
KING CRAB KID GOGGLES LIME	DE202267	6	12,49	11,24	9,99	19,99
KING CRAB KID GOGGLES PINK/FRAME PINK	DE202240	6	12,49	11,24	9,99	19,99
KING CRAB KID GOGGLES LILAC/FRAME LILAC	DE202241	6	12,49	11,24	9,99	19,99
KING CRAB KID GOGGLES CLEAR/FRAME CLEAR	DE202260	6	12,49	11,24	9,99	19,99
KING CRAB KID GOGGLES BLUE/FRAME BLUE	DE202263	6	12,49	11,24	9,99	19,99
KING CRAB KID GOGGLES ASSORTED	DE202299	12	12,49	11,24	9,99	19,99



CRESSI  
KIDS



MADE IN  
ITALY

U.S. PAT  
5.956.778

MICROMETRIC  
ADJUSTABLE BUCKLE

100% ANTI  
UV LENS

ANTI  
SCRATCH LENS

ANTI  
FOG LENS

2 - 7  
YEARS

# CRAB

## KID'S SWIM MASK 2-7 YEARS

Sophisticated silicone goggles specifically designed for children aged approximately between 3 and 7 years. Completely flat lenses for perfect vision even at the edges. Ideal for swim lessons. Shatterproof lenses with UV protection and scratch-resistant external treatment and internal

anti-fog treatment Cressi high technology for a perfect fit on most facial profiles and high comfort. Intercambiabile strap instantly with patented buckles with micrometric adjustment and immediate, similar to those of the Cressi-sub diving masks Boy and Girl version.

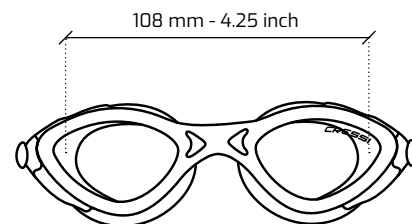

PRODUCT	CODE	PACK	DLR €	10%	SEASONAL ORDER 20%	RRP €
CRAB KID GOGGLES LIME	DE203167	6	12,49	11,24	9,99	19,99
CRAB KID GOGGLES BLUE/FRAME BLUE	DE203120	6	12,49	11,24	9,99	19,99
CRAB KID GOGGLES PINK/FRAME PINK	DE203140	6	12,49	11,24	9,99	19,99
CRAB KID GOGGLES LILAC/FRAME LILAC	DE203141	6	12,49	11,24	9,99	19,99
CRAB KID GOGGLES CLEAR/FRAME CLEAR	DE203160	6	12,49	11,24	9,99	19,99
CRAB KID GOGGLES CLEAR/FRAME CLEAR AZURE LENS	DE203161	6	12,49	11,24	9,99	19,99
CRAB KID GOGGLES LIGHT BLUE	DE203122	6	12,49	11,24	9,99	19,99
CRAB KID GOGGLES ASSORTED	DE203199	12	12,49	11,24	9,99	19,99



# BAGS & BACKPACKS



Photo by: Cristian Umili



Photo by: Jason Washington



# JUMBO ATELIER offline product

600-DENIER TWISTED POLYESTER FILAMENT | WATERP REPELLANT MATERIAL | YKK ZIP | PVC LAMINATION | 140 L

## WHEELED BAG & BACKPACK

The Jumbo bag is designed for very demanding divers who want to organize transport of all the equipment they need for their dives during their holiday travels or free time. The ample volume (140 liters) and internal partitioning makes luggage easy to prepare. The two side pockets, with the fin logo inside, can hold a pair of large fins, up to size XXL. The two front pockets are handy for packing accessories, like towels, t-shirts and sunglasses. The top pocket protects the two-position telescopic

handle and also conceals a special small pocket inside for a personal details card. The spacious inside compartment has room to organize all technical equipment up to size XXL (e.g. a complete 7 mm hooded wetsuit, jacket, boots, gloves, mask, mouthpiece, regulator, etc.), securing it with two special straps. The system of buckles on the outside allows the bag to be compacted further, by pulling on the straps according to how much is packed in it. The large wheels are highly resistant

and easily replaceable, as they are attached with screws and locknuts. The shoulder straps can be easily concealed in the back pocket and pulled out when needed. The new adjustment buckles on the shoulder straps allow rapid adjustment, even with the bag on the back.



### TECHNICAL FEATURES

- Made of 600 Denier twisted polyester fabric, with PVC water-repellent coating
- YKK Zippers
- Adjustable shoulder straps for carrying as a backpack

### DIMENSIONS

<b>Volume</b>	140 L
<b>Weight</b>	4,5 kg 10 lbs
<b>Dimensions</b>	80 x 50 x 35 cm 31.5 x 19.7 x 13.8 inch



PRODUCT	CODE	DLR €	10%	SEASONAL ORDER 20%	RRP €
JUMBO TROLLEY BAG	UB932500	187,49	168,74	149,99	299,99





**WHALE**  **SPECIALIZED**  
Retailer-Product

YKK ZIP | 140 L

**WHEELED BAG & BACKPACK - SEMI RIGID CASE**

Whale Scuba Bag is a capacious trolley designed to carry diving equipment. It is made of 1000 denier nylon with polyurethane coating and YKK zipper. The rigid back panel is made of thermoformed EVA. It is very versatile, thanks to the telescopic handle and the adjustable and removable shoulder straps (useful when, for example, you are shipping luggage).

Whale Scuba Bag is equipped with strong lateral compression straps, ideal to reduce the volume of the bag to the maximum once it is filled up.

**TECHNICAL FEATURES**

- Made of 1000 Nylon with polyurethane coating
- YKK Zippers
- Removable shoulder straps for carrying as a backpack

**DIMENSIONS**

<b>Volume</b>	140 L
<b>Weight</b>	3.85 kg 8.48 lbs
<b>Dimensions</b>	75 x 42 x 38 cm 29.5 x 16.5 x 14.9 inch



PRODUCT	CODE	DLR €	10%	SEASONAL ORDER 20%	RRP €
WHALE SCUBA BAG	XUA926050	149.99	134.99	119.99	249.99



# MOBY 5

YKK ZIP | EXTRA POCKETS | 115 L

## WHEELED BAG & BACKPACK

It is made from a new 300/400 denier material that is light yet very strong. The main compartment opens on three sides allowing easy access. There are two large bellows pockets to the front with zip closures, two side pockets for fins and a small upper pocket that holds an address tag. There are also two adjustable, padded, straps for carrying on the back that can be placed in special pockets when the backpack is being

forwarded. The reinforced pull handle is telescopic and fully retractable. The wheels have a large diameter and can be removed and easily replaced in the event of breakage. There are two carrying handles: a reinforced one at the top and one with Velcro closure at the bottom. The back of the bag houses supporting rods to keep the Moby 5 in a vertical position. All the zips are very strong YKK.



### DIMENSIONS

<b>Volume</b>	115 L
<b>Weight</b>	4,9 kg 10.8 lbs
<b>Main compartment</b>	76 x 40 x 28 cm 30 x 15.8 x 11 inch
<b>Upper front pocket</b>	34,4 x 23 x 8,5 cm 13.5 x 9.05 x 3.3 inch
<b>Lower front pocket</b>	34 x 38 x 8,5 cm 13.4 x 15 x 3.3 inch
<b>Fin pocket</b>	73 x 25 x 7 cm 28.7 x 9.8 x 2.8 inch



PRODUCT	CODE	DLR €	10%	SEASONAL ORDER 20%	RRP €
MOBY 5 TROLLEY BAG	UB932200	143.74	129.37	114.99	229.99

# MOBY LIGHT HYDRO NEW 2023

WATERPROOF MATERIAL | EXTRA POCKET | 85 L

## WATER RESISTANT WHEELED BAG

It is made from sturdy waterproof material. The main compartment opens on three sides allowing easy access. The reinforced pull handle is telescopic and fully

retractable. The back of the bag houses supporting rods to keep the Moby Light Hydro in a vertical position.



### TECHNICAL FEATURES

- Made of sturdy waterproof material
- Large capacity and small size/weight
- Upper Front Pocket

### DIMENSIONS

<b>Volume</b>	85 L
<b>Weight</b>	3,8 kg 8.38 lbs
<b>Dimensions</b>	73 x 41 x 30 cm 28.7 x 16.1 x 11.8 inch



PRODUCT	CODE	DLR €	10%	SEASONAL ORDER 20%	RRP €
MOBY LIGHT HYDRO TROLLEY BAG	XUB932356	143,74	129,37	114,99	229,99



# MEGATTERA

## DRY DIVING BAG WITH SPECIAL FINS COMPARTMENT

Megattera is a diving bag to carry all your equipment and accessories. It's equipped with handles and adjustable shoulder strap.

Megattera is strong and capacious. It is made of 500 denier tarpaulin, while for the bottom the same material has been used but with an anti-abrasion treatment.

Equipped with a practical upper zipper to easily insert all the accessories and diving equipment, Megattera has two pockets designed especially for divers. The first is external and closed with a buckle, perfect for carrying diving fins; the second pocket is a waterproof internal compartment for carrying equipment and wet clothes.



### TECHNICAL FEATURES

- Made of 500 D Tarpaulin
- Diving equipment pockets
- Waterproof internal compartment

### DIMENSIONS

<b>Volume</b>	110 L
<b>Weight</b>	2,10 kg 8.48 lbs
<b>Dimensions</b>	83 x 41 x 34 cm 32.7 x 16.2 x 13.4 inch



PRODUCT	CODE	DLR €	10%	SEASONAL ORDER 20%	RRP €
MEGATTERA BAG BLACK/YELLOW	XUA926150	74.99	67.49	59.99	119.99



# PIPER

## ULTRALIGHT TROLLEY | 2.9 KG

IDEAL FOR TRAVEL | 50 L

**Dimensions** 35.5 x 23 x 56 cm  
14 x 9 x 22 inch

The Piper is a suitcase designed and especially convenient for air travel, with a special 2 stage telescoping handle and 2 exterior compression straps with quick-release buckles. Several zippers, heavy-duty wheel housing, bumper protection, and scratch-resistant denier fabric ensure that your equipment will be able to be stored safely. Grab handles on the top, side, and bottom of the suitcase make this very easy to hold. The interior of the Piper features compression straps and a side ID pocket to help organize your belongings. A back ID pocket makes it possible to label your suitcase. At 6.4 pounds and 1.73 cubic feet, the Piper is light and great for traveling. Its dimensions are compliance with the carry-on airplane regulations.



PRODUCT	CODE	DLR €	10%	SEASONAL ORDER 20%	RRP €
PIPER TROLLEY BAG	UB952000	99.99	89.99	79.99	159.99

# DRY WETSUIT BAG

Practical dry or wet suit bag. Can be completely opened and used as a changing mat so as to avoid contact with the ground.



**Dimensions** 75 x 52 x 5 cm  
29.55 x 20.49 x 1.97 inch

PRODUCT	CODE	DLR €	10%	SEASONAL ORDER 20%	RRP €
BAG FOR DRY SUIT	UB953000	21.24	19.12	16.99	34.99

# REGULATOR BAG

The 360 Regulator Bag is a case for protecting scuba diving regulators and octopus. With an adjustable shoulder strap, made of strong nylon. The foam lining acts as a protective covering. The closure is with YKK® zip that ensures a perfect seal.



**Dimensions** Ø 36 x 11 cm  
Ø 14.25 x 4.33 inch

PRODUCT	CODE	DLR €	10%	SEASONAL ORDER 20%	RRP €
360 REGULATOR BAG	UB940000	24.99	22.49	19.99	39.99

# TUNA

## WHEELED BAG - FITS LONG BLADE FINS

The Tuna bag has a rigid bottom, thanks to the structure that supports the rubber and anti-breakage wheels. It is designed to carry diving equipment more comfortably. The material is water-repellent, even if not watertight. All metal components are made of rustproof stainless steel. The capacity is 120 litres. It is equipped with

a large internal mesh pocket with zip and a small external pocket with zip. Three inner straps are attached to the bottom of the structure to secure the equipment. At the top end there is a handle for towing and another handle is at the bottom end. In the middle of the bag, two more handles can be joined with a padded strap.

WATERPROOF POLYESTER | EXTERNAL WATERPROOF POCKET | 120 L

### TECHNICAL FEATURES

- Waterproof bag
- Made of Polyester
- External pocket
- Side handles and shoulder straps

### DIMENSIONS

<b>Volume</b>	120 L
<b>Weight</b>	3,45 kg 7,60 lbs
<b>Dimensions</b>	95 x 40 x 35 cm 37,4 x 15,75 x 13,78 inch



Inside straps



Semi rigid case



With wheels



PRODUCT	CODE	DLR €	10%	SEASONAL ORDER 20%	RRP €
TUNA WHEEL BAG BLACK/RED 120LT	XUB976200	131.24	118.12	104.99	209.99



# GORILLA PRO

## XL SIZE DRY BAG

A large and roomy bag, plenty of space for storage. Internal capacity of 4.75 cu ft (135 liters). The bag is long enough to hold even the long free diving fins. It is made from a strong radio frequency (RF) welded seam PVC and is waterproof. Equipment can be washed with water while still inside the bag.

Once you have finished washing your gear the bag has a special draining cap situated at one end to let water out easily and conveniently. Comes with handy top grab carry handles and two straps that can also be used as shoulder straps. No water comes out when transported, even by car.

135 L | WATER RESISTANT ZIPPER | HIGH FREQUENCY WELDING | FOR GARA FINS

### TECHNICAL FEATURES

- High-frequency welding
- Water-resistant zipper
- Special release cap
- Can fit the freediving fins as the Gara

### DIMENSIONS

Volume 135 L

Weight 1.6 kg  
3.5 lbs

Dimensions 95 x 34 x 42 cm  
37.4 x 13.4 x 16 inch



Electronically welded



Special release cap



Zipped external pocket



PRODUCT	CODE	DLR €	10%	SEASONAL ORDER 20%	RRP €
GORILLA PRO BAG	UA925710	72.49	65.24	57.99	115.99

# GORILLA NEW 2023

## XL SIZE DRY BAG

A large and roomy bag, plenty of space for storage. Internal capacity of 4.75 cu ft (135 liters). The bag is long enough to hold even the long free diving fins. It is made from a strong radio frequency (RF) welded seam PVC and is waterproof. Equipment can be washed with water while still inside the bag.

Once you have finished washing your gear the bag has a special draining cap situated at one end to let water out easily and conveniently. Comes with handy top grab carry handles and two straps that can also be used as shoulder straps. No water comes out when transported, even by car.

135 L | WATER RESISTANT ZIPPER | HIGH FREQUENCY WELDING

### TECHNICAL FEATURES

- High-frequency welding
- Water-resistant zipper
- Special release cap
- Can fit the freediving fins as the Gara

### DIMENSIONS

**Volume** 135 L

**Weight** 1.5 kg  
3.4 lbs



Electronically welded



Special release cap



PRODUCT	CODE	DLR €	10%	SEASONAL ORDER 20%	RRP €
GORILLA BAG BLACK/RED	XUA925458	49.99	44.99	39.99	79.99

# DRY GARA

## RESISTANT DRY BACKPACK

The Dry Gara Backpack is waterproof, ideal for carrying your equipment comfortably. It is made of durable PVC laminated Tarpaulin heat-sealed by high frequency of 5 tenths of a thickness: almost 100% watertight and, therefore, very practical not to wet the boot of the vehicle.

Adjustable anatomical shoulder straps, with 40 mm straps, adjustable chest strap, and waist strap. Heat-sealed padding. Capacity of 60 liters, ideal for complete equipment adding, also, the longest fins for diving or apnea. Two straps on each side that allow the transport of two spearguns.

60 L | 2 X GUN-HOLDER | HIGH FREQUENCY WELDING | FOR GARA FINS

### TECHNICAL FEATURES

- Ideal for Gara fins
- High-frequency welding
- 2x gun holder
- 100% Dry Bags

### DIMENSIONS

Volume	60 L
Weight	1.12 kg 2.47 lbs
Dimensions	39.5 x 23.5 x 66 cm 15.5 x 9.25 x 26 inch

### Folding

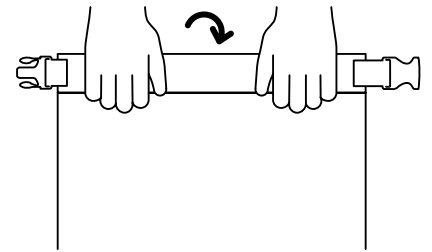

PRODUCT	CODE	DLR €	10%	SEASONAL ORDER 20%	RRP €
DRY GARA BAG 60lt	UA925800	49,99	44,99	39,99	89,99





# PIOVRA XL

| 85 L / 90 L | WATER REPELLANT | FOR FREEDIVING AND SPEARFISHING EQUIPMENT | SPEARGUN HOLDER

## LONG BLADE FINS BACKPACK WITH WATER REPELLANT TREATMENT

The Piovra backpack bag is perfect for sport spearfishing equipment. It is made of water-repellent DRY material, even if not watertight. The main compartment, with breathable anti-moisture mesh at the bottom, can accommodate freediving fishing gear, such as wetsuit, long fins (up to 100 cm / 39.37 in), mask, mouthpiece, belt, knife and various accessories. The secondary compartment, i.e. the outside pocket, is as a "cool" type

refrigerator bag for the transport of cold drinks or fish. The external elastic with braided laces allows to insert other objects, such as the towel. The two sides are equipped with fixing systems for two spearguns. There is a D-ring at the top of the bag. The two carrying straps are adjustable and a side handle makes it easier to grip. A reflective print on the front ensures greater visibility. The main compartment has eyelets for padlock.

### TECHNICAL FEATURES

- Dry material
- "Cool" external refrigerator pocket
- Long fins compartment
- Gun holder

### DIMENSIONS

<b>Volume</b>	85 L / 90 L
<b>Weight</b>	1.6 kg 3.5 lbs
<b>Dimensions</b>	112 x 30 x 30 cm 44,13 x 11,8 x 11,8 inch



PRODUCT	CODE	DLR €	10%	SEASONAL ORDER 20%	RRP €
PIOVRA FINS BACKPACK XL	XVB990101	74,99	67,49	59,99	119,99

# DRY GUN BAG

YKK ZIP 840 DENIER NYLON

## DRY BAG

A beautiful bag for carrying the spearguns. It features an adjustable shoulder strap and a reinforced handle. It has YKK zip closing long 52.5 in | 133 cm. Inside there is a small pocket with velcro closure. On the top, you can roll and close firmly thanks to the adjustable buckles.

Thanks to the special coating the bag is waterproof and will protect the equipment inside. It is long approximately 70 in (179 cm), enough for carrying long spearguns or other equipment. It is an ideal bag for the spearfishing man that want to protect and easily transport his gear.

### TECHNICAL FEATURES

- Waterproof bag
- Made of 840 Denier nylon
- YKK zip closing
- Side handles and shoulder straps

### DIMENSIONS

Dimensions 179 x 30.5 x 20 cm  
70 x 12 x 7.9 inch

### Folding

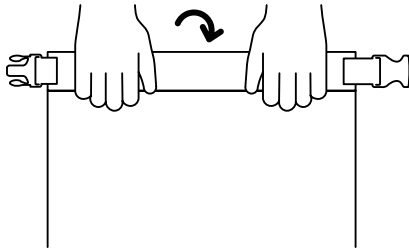

PRODUCT	CODE	DLR €	10%	SEASONAL ORDER 20%	RRP €
DRY GUN BAG	UA926200	66,24	59,62	52,99	104,99



# ROATAN NEW 2023

## HEAVY DUTY MESH BAG 123 L

The Roatan mesh liter bag is perfect to keep all your scuba diving gear together. Made with high-density polyester, this mesh bag makes carrying your gear easy. The bag is equipped with two access points - a drawstring on the top and a full-length zipper on the side- to make retrieving equipment easy, even if wet. The bag can be worn like a backpack, with padded, adjustable shoulder

straps and chest strap. It can also be carried with two reinforced handles, one on the side and one on the top. Included is a semi-dry front pocket with a zipper closure. A drain in the reinforced PVC bottom ensures that any water empties out, making this a perfect option to rinse your gear after use.

123 L | MESH BAG FOR DRAINING/RINSING EQUIPMENT | MADE WITH HIGH-DENSITY POLYESTER

### TECHNICAL FEATURES

- Mesh bag for draining wet equipments
- Made with high-density polyester
- Reinforced PVC bottom
- Back pocket with zip
- Volume: 123 Liters



PRODUCT	CODE	DLR €	10%	SEASONAL ORDER 20%	RRP €
ROATAN HEAVY DUTY DIVE BAG 123 lt	UB936000	49.99	44.99	39.99	79.99



# GORGONA

## TRAVEL MESH BAG

<b>Volume</b>	107 L
<b>Weight</b>	0,75 kg 1.65 lbs
<b>Dimensions</b>	38 x 38 x 96 cm 14.96 x 14.96 x 37.79 inch
<b>Materials</b>	70% Polyester Mesh - 30% 600D Polyester PUX2

- Travel mesh bag practical to carry or rinse the equipment
- The length is sized to house even the longest freediving fins
- Bag easily foldable for becoming a practical round bag with handle (diameter 38 cm - 14.96 inch)
- YKK Zippers

PRODUCT	CODE	DLR €	10%	SEASONAL ORDER 20%	RRP €
GORGONA BAG BLACK	UA925900	38.74	34.87	30.99	59.99



# CRETE

## TRAVEL MESH BAG

<b>Volume</b>	64,5 L
<b>Weight</b>	0,57 kg 1.25 lbs
<b>Dimensions</b>	37 x 37 x 67 cm 14.5 x 14.5 x 26.3 inch

- Travel mesh bag practical to carry or rinse the equipment

PRODUCT	CODE	DLR €	10%	SEASONAL ORDER 20%	RRP €
CRETE SNORKELING BAG BLUE	UA929120	33.74	30.37	26.99	54.99



# DRY BOX

## DRY HARD CASE

<b>Dimensions</b>	6 x 6 x 11 cm 2.4 x 2.4 x 4.4 inch
<b>Internal Diameter</b>	5 cm 2 inch

- Strong plastic
- Watertight
- Quick closing strap



PRODUCT	CODE	DLR €	10%	SEASONAL ORDER 20%	RRP €
DRY BOX	TA700003	7.49	6.74	5.99	11.99

# NET BAG

## MESH BAG

Mesh bag to attach to the waist for small accessories and light equipment. The net is attached to the waist by an adjustable belt complete with quick-release fastex buckle. An elastic band keeps the opening of the net closed, snug against the body of the diver so he can rapidly open the net to take out or replace accessories and equipment.



PRODUCT	CODE	DLR €	10%	SEASONAL ORDER 20%	RRP €
NET BAG	TA615000	16.24	14.62	12.99	25.99





## FOR YOUR DOG'S SAKE

Cressi Dog is a new line dedicated to dogs by Cressi and designed to promote the well-being and security of the animal in its relationship with water, so that it can live this experience in total harmony and serenity.

CRESSI DOG





# DLJ DOG LIFE JACKET

## DON'T SINK, FLOAT AND SWIM

The Dog Life Jacket is a garment of Duratex 1000 denier black fabric (like Cordura) and Polyester 500 denier (goose-beak yellow) specifically designed to keep the animal on the surface or to facilitate it to swim. It is the necessary equipment for rescue dogs in water and is very useful for rehabilitation. It has a practical ring for the leash and a comfortable handle (three in sizes L-XL) to facilitate the recovery of the dog when you are on the boat.

The jacket has been exactly achieved to keep the dog in the correct swimming position and to facilitate its movements, both when it is submerged and on the surface. The Life Jacket is ergonomic, comfortable and easy to wear. The 7 sizes range is from Micro 2XS to XL. This product has also been designed to be used over the Cressi Dog Wetsuit, which further increases the dog's protection against the cold.



### TECHNICAL FEATURES

- Padding made of material with intrinsic buoyancy
- Duratex 1000 denier fabric and polyester 500 denier
- Double strip of high-visibility silver reflective material EN471 and inserts of the same material
- Embroidered logos and rubberized logo
- Two ventral padded bands for greater dog comfort

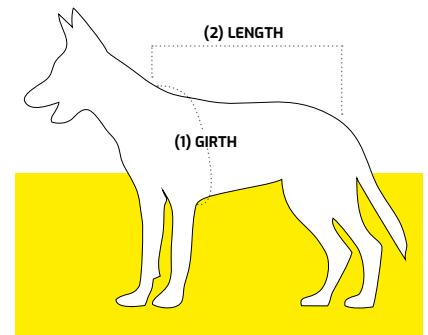

SIZE	WEIGHT - KG	(1) GIRTH - CM	(2) LENGTH - CM
M2XS	-	26 - 42	22 - 30
MXS	-	30 - 50	26 - 35
XS	7 - 11	48 - 81	25 - 33
S	9 - 20	53 - 89	33 - 41
M	18 - 27	64 - 99	38 - 50
L	27 - 41	69 - 111	43 - 61
XL	> 41	76 - 122	51 - 66

SIZE	WEIGHT - LB	(1) GIRTH - INCH	(2) LENGTH - INCH
M2XS	-	10 - 16.5	8.5 - 12
MXS	-	12 - 19.5	10 - 13.5
XS	15 - 25	19 - 32	10 - 13
S	20 - 45	21 - 35	13 - 16
M	40 - 60	25 - 39	15 - 20
L	60 - 90	27 - 44	17 - 24
XL	> 90	30 - 48	20 - 26

PRODUCT	SIZE	CODE	DLR €	10%	SEASONAL ORDER 20%	RRP €
DOG LIFE JACKET	M2XS	LB500002	46,24	41,62	36,99	73,99
DOG LIFE JACKET	MXS	LB500003	46,24	41,62	36,99	73,99
DOG LIFE JACKET	XS	LB500004	57,49	51,74	45,99	91,99
DOG LIFE JACKET	S	LB500005	57,49	51,74	45,99	91,99
DOG LIFE JACKET	M	LB500006	68,74	61,87	54,99	109,99
DOG LIFE JACKET	L	LB500008	68,74	61,87	54,99	109,99
DOG LIFE JACKET	XL	LB500009	68,74	61,87	54,99	109,99

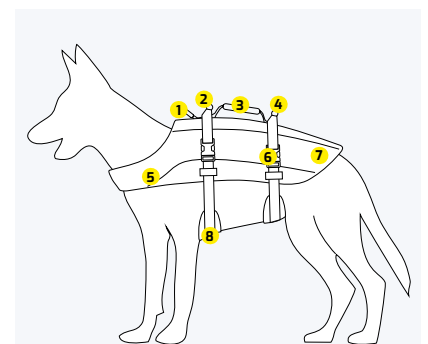
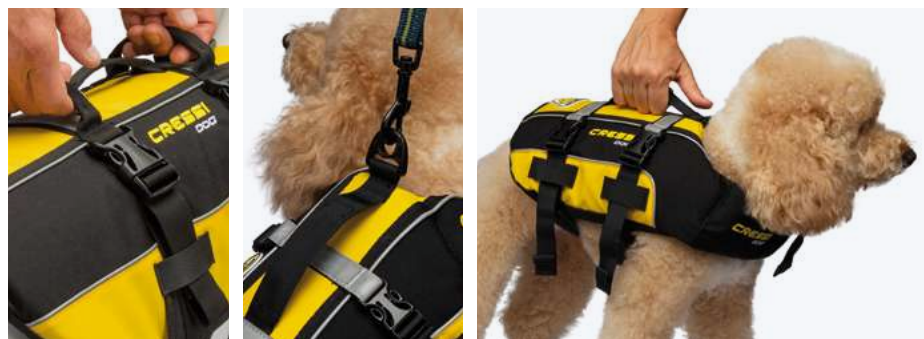

1. D-Ring anchor point, to attach the leash and/or an eventual signalling night light
2. Additional handle (L-XL)
3. Comfortable handle to facilitate recovery of the dog from the boat or the swimming pool
4. Additional handle (L-XL)
5. High visibility profiles
6. High strength buckles
7. Anatomic Design
8. Padded band



# DWS DOG WETSUIT

## KEEPS YOUR DOG WARM AND SAFE

The Dog Wetsuit is a 3 mm thick neoprene bodysuit that isolates the body of the animal and protects it from the cold, thanks to the air cells of its structure which, at the same time, facilitate the buoyancy. The use of the wetsuit, due to its thermal characteristics, can avoid the onset of swimmer's tail syndrome. The soft material that wraps the dog gives it a reassuring effect and promotes calm and self-control.

The Dog Wetsuit presents a cut that follows canine anatomy and allows free movements avoiding any constriction. The garment has a comfortable full-opening zipper on the back, which facilitates dressing. The 11 sizes range is from Micro XS to XXL. This product has also been designed to be used under the Cressi Dog Life Jacket, which further increases the dog's buoyancy.

HIGH BUOYANCY | COMFORTABLE | DURABLE

### TECHNICAL FEATURES

- Made of 100% neoprene
- Available in 11 different sizes
- Bright color for more visibility
- Rubberized logo
- Back closure zip

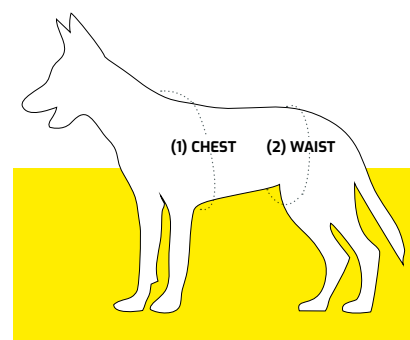

SIZE	(1) CHEST	(2) WAIST
MicroXS	27-32 cm (10.5-13 inch)	23-26 cm (9-10.5 inch)
3XS	34-37 cm (13.5-15 inch)	25-28 cm (10-11 inch)
2XS	40-43.5 cm (16-17 inch)	30-33.5 cm (11.8-13 inch)
XS	44-47 cm (17-19 inch)	34-37.5cm (13.4-14.8inch)
S	47-50.5 cm (19-20 inch)	37-40.5 cm (14.5-16 inch)
S/M	55-58 cm (22-23 inch)	42-45 cm (16.5-17.7 inch)
M	61-64 cm (24-25 inch)	47-50 cm (18.5-19.7 inch)
ML	66-69 cm (26-27 inch)	53-55 cm (20.8-21.7 inch)
L	75-78 cm (29.5-31 inch)	59-62 cm (23-24 inch)
XL	84-87 cm (33-34 inch)	66-69 cm (26-27 inch)
2XL	89-92 cm (35-36 inch)	71-74 cm (28-29 inch)

PRODUCT	SIZE	CODE	DLR €	10%	SEASONAL ORDER 20%	RRP €
DOG WETSUIT 3 mm	MICRO XS	LB100001	49,99	44,99	39,99	79,99
DOG WETSUIT 3 mm	3XS	LB100002	49,99	44,99	39,99	79,99
DOG WETSUIT 3 mm	2XS	LB100003	49,99	44,99	39,99	79,99
DOG WETSUIT 3 mm	XS	LB100004	49,99	44,99	39,99	79,99
DOG WETSUIT 3 mm	S	LB100005	49,99	44,99	39,99	79,99
DOG WETSUIT 3 mm	SM	LB100006	49,99	44,99	39,99	79,99
DOG WETSUIT 3 mm	M	LB100007	49,99	44,99	39,99	79,99
DOG WETSUIT 3 mm	ML	LB100008	49,99	44,99	39,99	79,99
DOG WETSUIT 3 mm	L	LB100009	49,99	44,99	39,99	79,99
DOG WETSUIT 3 mm	XL	LB100010	49,99	44,99	39,99	79,99
DOG WETSUIT 3 mm	2XL	LB100011	49,99	44,99	39,99	79,99

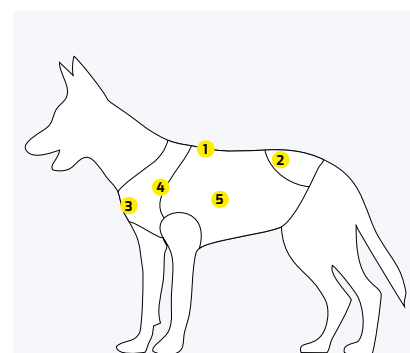

1. Zippered opening
2. Anatomic Design
3. Freedom of movement
4. Thermal protection
5. 100% neoprene vest



# #SHARE YOUR EXPERIENCE

FOLLOW US



Official Website

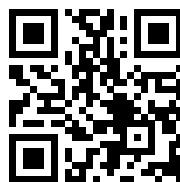

[www.cressidog.com](http://www.cressidog.com)

Official Blog



[www.blog.cressidog.com](http://www.blog.cressidog.com)



# DIVE TORCHES





/ DIVE TORCHES

# LUMIA+

## ULTRA LED DIVE LAMP

- WHITE COLOR TEMPERATURE
- ADJUSTABLE ELASTIC STRAP
- EXCELLENT ERGONOMICS
- SWITCH WITH 3 POSITIONS
- LED LIGHT TECHNOLOGY
- PREMIUM MATERIALS
- NARROWED LIGHT BEAM

Torch with a highly asymmetric design boasts excellent ergonomics and a highly tactile perception of its geometric characteristics. Thanks to this particular design, the switch position is immediately found without needing to use your eyesight. The porthole and body are coated with thermoplastic rubber to extend shelf life and reduce noises from impact when used for fishing. These ergonomic features are a big advantage over aluminium torches with a circular section which do not give feedback on the position of the grip and, in some cases, even require the use

of two hands to turn it on. The switch has three positions: Off, On Unstable with Automatic Return, On. The "On Unstable" position is particularly useful in fishing because it allows flashing by one simple press. The strap with slider spring allows adjustment according to the user's needs, but being elastic can be pulled out in case of emergency. Power is supplied by four AA "Stylus" batteries, either alkaline or rechargeable. The electronics ensure a constant level of brightness even when the batteries are rechargeable and/or not fully charged. Batteries included.

<b>Length</b>	168 mm - 6.61 inch
<b>Head diameter</b>	47 mm - 1.85 inch
<b>Weight</b>	130 gr - 4.58 OZ (without batteries)

### NEW WHITE COLOR TEMPERATURE

The LED has a white color temperature similar to sunlight for maximum return of the colors in the underwater environment. The light beam of the LED is narrowed into a spot light beam of about 6° by means of a lens made of ultra-transparent material protected by the polycarbonate optical porthole.

### ACTIVE ELECTRONICS

Power is supplied by four AA "Stylus" batteries, either alkaline or rechargeable. The power supply has an electronic management system that eliminates the gap between the different electrical potentials of different types of batteries and ensures an efficiency of 30% higher than the commonly used systems. The active electronics of the flashlight guarantee constant light, even when the battery charge decreases. When the charge drops below the safety threshold value, the lighting level will reduce to warn the user that the batteries are depleted.

### TECHNICAL CHARACTERISTICS

<b>Luminous Flux</b>	300 Lumens
<b>Color Temperature</b>	6500 °K CRI>75
<b>Burn Time</b>	3,5 h
<b>Viewing Angle</b>	6°
<b>Illuminance</b>	30000 Lux
<b>Impact Resistance</b>	1,5 m
<b>Ingress Protection Code</b>	IPX-8 75m

### LUMIA +

HIGH RANGE COLOR SPECTRUM



### STANDARD LIGHT

LIMITED RANGE COLOR SPECTRUM

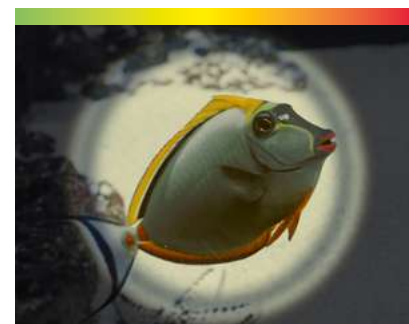

#### EXCELLENT ERGONOMICS

THANKS TO THERMOPLASTIC RUBBER COATING AND HIGHLY ASYMMETRIC DESIGN

#### SWITCH WITH 3 POSITIONS

OFF : ON UNSTABLE WITH AUTOMATIC RETURN : ON

#### NARROWED LIGHT BEAM

APPROXIMATELY 6° SPOT LIGHT BEAM THANKS TO TIR LENS

#### ADJUSTABLE ELASTIC STRAP

TO CUSTOMISE THE USAGE ACCORDING TO YOUR NEEDS

#### NEUTRAL WHITE COLOR TEMPERATURE

SIMILAR TO SUNLIGHT FOR MAXIMUM RETURN OF THE COLORS

NEW  
WHITE COLOR  
LED LIGHT



BLACK/SILVER



BLACK/BLACK

PRODUCT	CODE	DLR €	10%	SEASONAL ORDER 20%	RRP €
LUMIA+ TORCH BLACK/SILVER	SJ550170	68.74	61.87	54.99	109.99
LUMIA+ TORCH BLACK/BLACK	SJ550150	68.74	61.87	54.99	109.99



# KNIVES





# LIZARD



**SPECIALIZED**  
Retailer-Product

**NEW COLORS 2023**

## STAINLESS STEEL W 1.14116

Italian-made professional, multipurpose diver's knife, with blade and handle in w 1.14116 martensitic stainless steel, hardness HRC 55/56, for an extremely sharp and honed blade. A knife with a dagger handle designed specifically for fishing. In the body of the knife a part is intended for the

extraction of stranded shafts and for straightening them. The knife can be removed from its sheath quickly and with one hand thanks to a special mechanical system.



### DIMENSIONS

<b>Blade length</b>	10,5 cm - 4.13 inch
<b>Total length</b>	21 cm - 8.26 inch
<b>Thickness blade</b>	3,8 mm - 0.15 inch

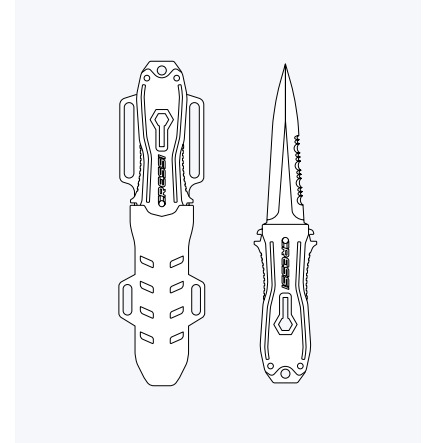

BLACK/BLACK

BLACK/RED

BLACK/GREEN

PRODUCT	CODE	DLR €	10%	SEASONAL ORDER 20%	RRP €
LIZARD KNIFE BLACK	RC559600	39,99	35,99	31,99	63,99
LIZARD KNIFE RED	RC559680	39,99	35,99	31,99	63,99
LIZARD KNIFE GREEN	RC559690	39,99	35,99	31,99	63,99



# PREDATOR

## STAINLESS STEEL 420 + COATING

Small stiletto knife, designed for underwater fishing. Manageable, blade penetration and durability and grip. The blade extends through the interior of the handle and, at the end of the handle, has a small pommel. Tempered AISI 420 steel with Black Coating. The duration of these features is guaranteed not by the sharpness itself, but by the quality of the material that guarantees the durability of the blade. Rhomboidal cross section for greater resistance to flexing and breaking. Double-edged blade with one smooth-edged side and the other serrated. Comfortable handle with rubbery polymer coating.



<b>Blade length</b>	8.6 cm - 3.39 inch
<b>Total length</b>	18 cm - 7.1 inch
<b>Blade width</b>	17 mm - 0.67 inch
<b>Blade thicknesses</b>	3-5 mm - 0.1-0.2 inch
<b>Knife-only weight</b>	120 gr - 0.26 lb
<b>Weight with sheath</b>	200 gr - 0.44 lb

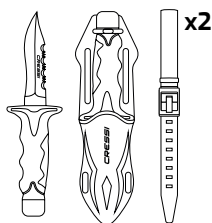

CODE	DLR €	10%	SEASONAL ORDER 20%	RRP €
RC554500	43,74	39,37	34,99	69,99

# FINISHER

## STAINLESS STEEL 304 + COATING

Medium-sized stiletto knife designed for underwater fishing. Manageable, high blade penetration and durability with a secure grip. The blade extends through the interior of the handle and, at the end of the handle, has a small pommel. Tempered AISI 304 steel with Black Coating. The duration of these features is guaranteed not by the sharpness itself, but by the quality of the material that guarantees the durability of the blade. Rhomboidal cross section for greater resistance to flexing and breaking. Double-edged blade with one smooth-edged side and the other serrated. Comfortable handle with rubbery polymer coating.



<b>Blade length</b>	12,7 cm - 5 inch
<b>Total length</b>	24,7 cm - 9.7 inch
<b>Blade width</b>	17 mm - 0.67 inch
<b>Blade thicknesses</b>	3-5 mm - 0.1-0.2 inch
<b>Knife-only weight</b>	130 gr - 0.28 lb
<b>Weight with sheath</b>	200 gr - 0.44 lb

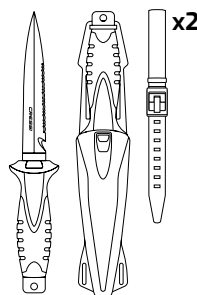

CODE	DLR €	10%	SEASONAL ORDER 20%	RRP €
RC559300	47,49	42,74	37,99	75,99

## KAI

## STAINLESS STEEL W 1.4060 + COATING

Italian-made professional diver's knife, with blade and handle in W 1.4060 martensitic stainless steel, hardness HRC 55/56, for an extremely sharp and honed blade. It has a V-shaped cross section blade and is equipped with a saw, a line cutter and a loop for the leash.

The Idroglider Gold Black surface treatment increases resistance to corrosion in marine environments.

Equipped with a 1000 D ballistic nylon sheath and neoprene legbands and armbands in several sizes to perfect fits.



Blade length	10 cm - 3.9 inch
Total length	23 cm - 9 inch
Blade width	30 mm - 1.2 inch
Blade thicknesses	4 mm - 0.15 inch
Knife-only weight	140 gr - 0.3 lb
Weight with sheath	180 gr - 0.39 lb

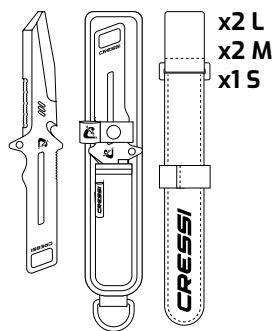

CODE	DLR €	10%	SEASONAL ORDER 20%	RRP €
RC559510	33,74	30,37	26,99	54,99

## KAI MINI

## STAINLESS STEEL W 1.4060 + COATING

Italian-made professional diver's compact multitool, with blade and handle in W 1.4060 martensitic stainless steel, hardness HRC 55/56, for an extremely sharp and honed blade. It has a V-shaped cross section blade and is equipped with a saw, a line cutter, a bottle opener and a loop for the leash.

The Idroglider Gold Black surface treatment increases resistance to corrosion in marine environments.

Equipped with a 1000 D ballistic nylon sheath and neoprene leg bands and armbands in several sizes to perfect fits.



Blade length	4.5 cm - 1.77 inch
Total length	11 cm - 4.33 inch
Blade width	30 mm - 1.2 inch
Blade thicknesses	4 mm - 0.15 inch
Knife-only weight	65 gr - 0.14 lb
Weight with sheath	90 gr - 0.19 lb

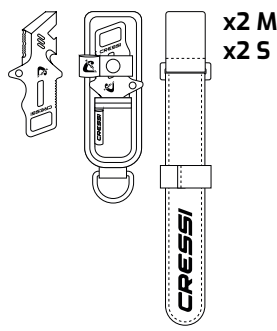

CODE	DLR €	10%	SEASONAL ORDER 20%	RRP €
RC559500	26,24	23,62	20,99	44,99

# ORCA

## STAINLESS STEEL

This legendary product has been around for years and years and has now become a sought-after collector's item. It is considerably heavy and large, perfect for a work tool, which this knife is designed to be. The large blade is forged from special steel, with a smooth edge on one side and partly serrated on the other. This side of the blade has a line cutter at the handle end. The anatomical, non-slip handle is made from soft grip material for a comfortable grip and comes with anatomical moulding for the fingers to fit into. On the back, it ends with a chrome-plated knob that can also be used as a mallet. The front of the handle ends with a stainless steel hilt to protect the fingers. The sheath is made from plastic and has a traditional elastic band to hold on the knife. It also has loops to attach the knife to your leg or onto your belt and comes with two leg straps.



Blade length	17,8 cm - 7.01 inch
Total length	30 cm - 11.82 inch
Blade width	32 mm - 1.25 inch
Blade thicknesses	5,5 mm - 0.22 inch
Knife-only weight	450 gr - 0.99 lb
Weight with sheath	600 gr - 1.32 lb

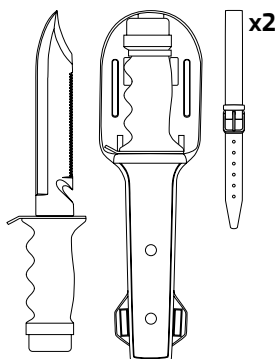

CODE	DLR €	10%	SEASONAL ORDER 20%	RRP €
RC556000	69,99	62,99	55,99	109,99

# BORG

## STAINLESS STEEL 420 & 304 + COATING

Borg is a modern, large knife with a futuristic design and a strong, tempered blade. One side of the stainless steel blade is straight-edged, the other one is serrated right along the blade; they are both very sharp and effective for line cutting.

Sheath with locking mechanism to allow one-hand release.

It is separated from the blade by a small technopolymer thumb tab.

The knife comes with two, standard issue straps to attach it to your leg.



Blade length	14,5 cm - 5.7 inch
Total length	26,8 cm - 10.5 inch
Blade width	25 mm - 1 inch
Blade thicknesses	5 mm - 0.19 inch
Knife-only weight	230 gr - 0.5 lb
Weight with sheath	330 gr - 0.72 lb

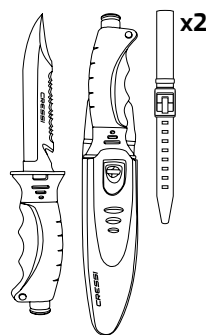

CODE	DLR €	10%	SEASONAL ORDER 20%	RRP €
RC559100	46,24	41,62	36,99	74,99



# NORGE

## STAINLESS STEEL

Norge is a modern, compact knife with a futuristic design and a strong, tempered blade. The anatomical, non-slip handle is made from soft grip material. It is separated from the blade by a small technopolymer thumb tab. The blade is made from special tempered stainless steel, with a smooth edge on one side and partly serrated on the other. This side of the blade has a line cutter at the handle end. The black technopolymer sheath comes with loops to attach it to leg or at the waist. The blade hooks onto the sheath with a quick-release spring slide that sits smoothly against the actual sheath. The knife comes with two, standard issue straps to attach it to your leg.



Blade length	11,7 cm - 4,61 inch
Total length	22,8 cm - 8,98 inch
Blade width	25 mm - 1 inch
Blade thicknesses	4,5 mm - 0,18 inch
Knife-only weight	140 gr - 0,3 lb
Weight with sheath	250 gr - 0,55 lb

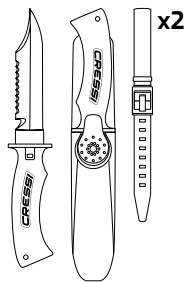

CODE	DLR €	10%	SEASONAL ORDER 20%	RRP €
RC553010	39,99	35,99	31,99	64,99

# SKORPION

## STAINLESS STEEL 420

Skorpion is a modern, medium-sized knife with a futuristic design and a strong, tempered blade. One side of the stainless steel blade is straight-edged, the other one is serrated right along the blade; they are both very sharp and effective for line cutting. It is separated from the blade by a small technopolymer thumb tab. Sheath with locking mechanism to allow one-hand release. The knife comes with two, standard issue straps to attach it to your leg.



Blade length	11 cm - 4,33 inch
Total length	23,5 cm - 9,25 inch
Blade width	25,5 mm - 10,03 inch
Blade thicknesses	5 mm - 0,18 inch
Knife-only weight	200 gr - 0,3 lb
Weight with sheath	280 gr - 0,55 lb

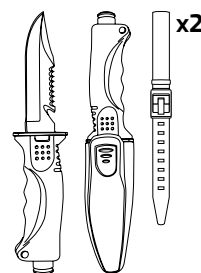

CODE	DLR €	10%	SEASONAL ORDER 20%	RRP €
RC559000	39,99	35,99	31,99	64,99

# SUPERTOTEM

## STAINLESS STEEL

An inexpensive, average-size knife with an excellent quality-price ratio. One side of the stainless steel blade is straight-edged, the other one is serrated right along the blade; they are both very sharp and effective for line cutting. The anatomic grip is made from technopolymers and has a series of moulds for the fingers, ending with a thumb protection tab at the blade end. The plastic sheath holds the knife firmly with a traditional elastic band and has loops to attach it to the leg or strap. The knife comes with two, standard issue straps to attach it to your leg.



Blade length	12,4 cm - 4,89 inch
Total length	23,2 cm - 9,14 inch
Blade width	32 mm - 1,25 inch
Blade thicknesses	3 mm - 0,12 inch
Knife-only weight	120 gr - 0,26 lb
Weight with sheath	210 gr - 0,46 lb

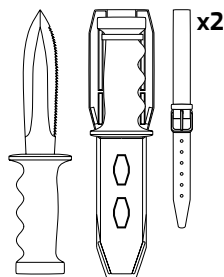

CODE	DLR €	10%	SEASONAL ORDER 20%	RRP €
RC550000	21,88	19,69	17,50	34,99

# VIGO

## STAINLESS STEEL

Blades are made from stainless steel specifically made for the marine environment. Sheath with locking mechanism to allow one-hand release. The knife comes with two, standard issue straps to attach it to your leg



Blade length	11,8 cm - 4,6 inch
Total length	23,5 cm - 9,2 inch
Blade width	25,2 mm - 1 inch
Blade thicknesses	5 mm - 0,19 inch
Knife-only weight	147 gr - 0,32 lb
Weight with sheath	217 gr - 0,47 lb

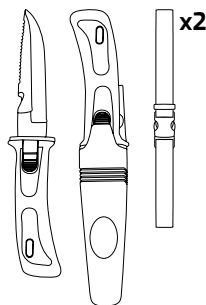

CODE	DLR €	10%	SEASONAL ORDER 20%	RRP €
RC555000	16,88	15,19	13,50	27,99

# KILLER

## STAINLESS STEEL

A small knife that's been around for years now, highly appreciated because it is easy to handle and the blade penetrates really well. This is forged from a single piece of stainless steel, and is blocked at the grip by a screw knob situated at the end of the grip. One side of the blade has a smooth cutting edge, the other is partly serrated.

The anatomical technopolymer grip ends at the blade with a thumb tab. The sheath is made from plastic and has a traditional elastic band to hold on the knife and loops to attach the knife to your leg or onto your belt.

The knife comes with two, standard issue straps to attach it to your leg.



<b>Blade length</b>	8,6 cm - 3.39 inch
<b>Total length</b>	18 cm - 7.09 inch
<b>Blade width</b>	25,2 mm - 1 inch
<b>Blade thicknesses</b>	3-5 mm - 0.12-0.2 inch
<b>Knife-only weight</b>	120 gr - 0.26 lb

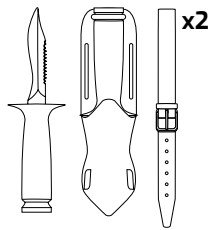

CODE	DLR €	10%	SEASONAL ORDER 20%	RRP €
RC554000	37,49	33,74	29,99	59,99

# GRIP

## STAINLESS STEEL 304

The Grip Spear is a small-sized knife with a tapered blade that makes it ideal for spearfishing.

The blade is made in stainless steel. It features a high precision dagger point tip. One side is an extra rigid serrated blade for sawing, the other side is a skillfully crafted straight blade. It features an ergonomic non-slip handle grip and a hole to add a lanyard (not included).

The knife comes with a sheath that can be attached to the BCD shoulder strap. The sheath has a locking mechanism that prevents the knife from falling out. With 2 rubber straps (included) you can fix the sheath to your leg or your arm. The straps are 20 in (50.8 cm) long.

Great for spear fishing or scuba diving; as primary knife or back-up.



<b>Blade length</b>	8,1 cm - 3.1 inch
<b>Total length</b>	17,4 cm - 6.8 inch
<b>Knife-only weight</b>	49 gr - 0.1 lb
<b>Weight + sheath</b>	85 gr - 0.18 lb

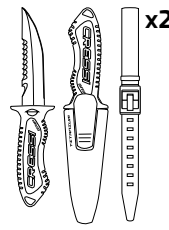

CODE	DLR €	10%	SEASONAL ORDER 20%	RRP €
RC559400	27,49	24,74	21,99	44,99



# MAIN KNIVES SPARE PARTS

PRODUCT	CODE	DLR €	10%	SEASONAL ORDER 20%	RRP €
KAI KNIFE SHEATH NYLON	RZ559500	8.74	7.87	6.99	13.99
KAI MINI KNIFE NYLON SHEATH	RZ559510	7.49	6.74	5.99	11.99
KIT LAMA APNEA	RZ550011	8.74	7.87	6.99	13.99
KIT LAMA ARA	RZ550010	8.74	7.87	6.99	13.99
KNIFE BLACK STRAPS (2pcs)	RZ550097	6.24	5.62	4.99	9.99
HOLDER KILLER KNIFE	RZ550008	3.13	2.82	2.50	4.99
HOLDER SUPERTOTEM/ORCA	RZ551007	3.13	2.82	2.50	4.99
SHEATH + STRAPS ORCA	RZ550003	14.99	13.49	11.99	23.99
SHEATH + STRAPS SUPERTOTEM	RZ550004	9.38	8.44	7.50	14.99
SHEATH + STRAPS NORGE	RZ550005	11.24	10.12	8.99	17.99
SHEATH + STRAPS KILLER	RZ550006	9.38	8.44	7.50	14.99



# KNIVES COMPARISON TABLE

## SCUBA KNIVES



PRODUCT	BLADE LENGTH	TOTAL LENGTH	BLADE WIDTH	BLADE THICKNESSES	KNIVE-ONLY WEIGHT	WEIGHT WITH SHEATH
KAI	10 cm 3.9 inch	23 cm 9 inch	30 mm 1.2 inch	4 mm 0.15 inch	140 gr 0.3 lb	180 gr 0.39 lb
KAI MINI	4.5 cm 1.77 inch	11 cm 4.33 inch	30 mm 1.2 inch	4 mm 0.15 inch	65 gr 0.14 lb	90 gr 0.19 lb
ORCA	17.8 cm 7.01 inch	30 cm 11.82 inch	32 mm 1.25 inch	5.5 mm 0.22 inch	450 gr 0.99 lb	600 gr 1.32 lb
BORG	14.5 cm 5.7 inch	26.8 cm 10.5 inch	25 mm 1 inch	5 mm 0.19 inch	230 gr 0.5 lb	330 gr 0.72 lb
NORGE	11.7 cm 4.61 inch	22.8 cm 8.98 inch	25 mm 1 inch	4.5 mm 0.18 inch	140 gr 0.3 lb	250 gr 0.55 lb
SKORPION	11 cm 4.33 inch	23.5 cm 9.25 inch	25.5 mm 10.03 inch	5 mm 0.18 inch	200 gr 0.3 lb	280 gr 0.55 lb
SUPERTOTEM	12.4 cm 4.89 inch	23.2 cm 9.14 inch	32 mm 1.25 inch	3 mm 0.12 inch	120 gr 0.26 lb	210 gr 0.46 lb

## SPEARFISHING KNIVES



PRODUCT	BLADE LENGTH	TOTAL LENGTH	BLADE WIDTH	BLADE THICKNESSES	KNIVE-ONLY WEIGHT	WEIGHT WITH SHEATH
LIZARD	10.5 cm 4.13 inch	21 cm 8.26 inch	n/a	3.8 mm 0.15 inch	n/a	n/a
PREDATOR	8.6 cm 3.39 inch	18 cm 7.1 inch	17 mm 0.67 inch	3-5 mm 0.1-0.2 inch	120 gr 0.26 lb	200 gr 0.44 lb
FINISHER	12.7 cm 5 inch	24.7 cm 9.7 inch	17 mm 0.67 inch	3-5 mm 0.1-0.2 inch	130 gr 0.28 lb	200 gr 0.44 lb
VIGO	11.8 cm 4.6 inch	23.5 cm 9.2 inch	25.2 mm 1 inch	5 mm 0.19 inch	147 gr 0.32 lb	217 gr 0.47 lb
KILLER	8.6 cm 3.39 inch	18 cm 7.09 inch	25.2 mm 1 inch	3-5 mm 0.1-0.2 inch	120 gr 0.26 lb	n/a
GRIP POINT TIP	8.1 cm 3.1 inch	17.4 cm 6.8 inch	n/a	n/a	49 gr 0.1 lb	85 gr 0.18 lb

# BUOYS



## SIGNAL BOARD BUOY

PVC WITH MESH COVER + 0.25 MM INNER BLADDER | 20 M LINE | CARRYING HANDLE | FLAG WITH 40 CM POLE | 4 POCKETS | SAFETY WHISTLE

Red for excellent visibility, it uses two casings: an outer skin made of abrasion-resistant material ensures excellent protection for the two inner inflatable chambers, which are white. A mesh cover makes the bottom abrasion-proof and ensures effective drainage so that the buoy retains its light weight at all times. The upper part is fitted with multipurpose pockets and a big expanding container. A mesh bag made of adjustable elastic straps will carry additional objects. A zipper along the centre gives access to the two air tubes, which are kept separate for fail-safe buoyancy. A casing for the pole of the flag required by regulations is provided in the centre of the front section of the float. Also Red, the line is about 20m long and is fitted with two plastic snap hooks. This buoy comes with a convenient whistle: an additional safety device.

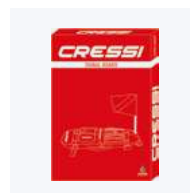

PRODUCT	CODE	DLR €	10%	SEASONAL ORDER 20%	RRP €
SIGNAL BOARD BUOY	TA611902	62.49	56.24	49.99	99.99

## SPYDER BOARD BUOY

BRIGHT RED COLOR FOR MAXIMUM VISIBILITY | FLAG WITH 40 CM POLE | 4 POCKETS

The buoy is double chamber type with an inner tube and an external protective cover. It is made from abrasion-resistant 420D nylon. Fluorescent red colour makes it highly visible. Holds 3 rifles. Buoy dimensions: 80 cm x 30 cm. The buoy has a double internal chamber to increase your safety. If one is pierced, the buoy will always be on the surface thanks to the other chamber. The three pockets are very practical for storing various accessories. A stabilising lead makes this buoy very stable even with the sea formed and with the top compartments occupied by heavy objects.



PRODUCT	CODE	DLR €	10%	SEASONAL ORDER 20%	RRP €
SPYDER BOARD BUOY	TA611900	56.24	50.62	44.99	89.99

## BUOY ROPE FOLDER



PRODUCT	CODE	DLR €	10%	SEASONAL ORDER 20%	RRP €
BUOY ROPE FOLDER	TA613000N	9.38	8.44	7.50	15.99



# TORPEDO BUOY

BRIGHT RED COLOR FOR MAXIMUM VISIBILITY CLASSIC TORPEDO SHAPED BUOY 0.35 MM PVC

The PVC used for this mono-camera buoy is very thick (0.35 mm) and is highly resistant to stress from sea activities. High-quality heat welded connections. The torpedo shape is very convenient for swimming because it eliminates any hydrodynamic resistance. It has a super slip tray finish, so that the buoy is the minimum resistance to the angler's progress. It is also very comfortable for rifles that can be positioned lengthly. Pole with "Diver Underwater" flag and 25 m rope.

<b>Diameter</b>	25 cm - 9.85 inch
<b>Height</b>	85 cm - 33.46 inch
<b>Volume</b>	about 15 L
<b>Weight</b>	680 gr - 1.5 lb



PRODUCT	CODE	DLR €	10%	SEASONAL ORDER 20%	RRP €
TORPEDO BUOY	TA611600	16,24	14,62	12,99	25,99

# EASY BUOY

WRAP-AROUND SYSTEM 20 M LINE 0.35 MM PVC

First-ever buoy to feature a built-in flag, it is fitted with a specially designed casing for the line that prevents the line from tangling up and makes it possible to adjust its length as a function of how deep you want to go. Pursuant to the regulations, its prevailing colour is red with a white stripe for immediate recognisability. Also red in colour, the line is about 20m long and is fitted with two plastic snap hooks. This buoy comes with a convenient whistle: an additional safety device that can be used to attract attention in an emergency situation.

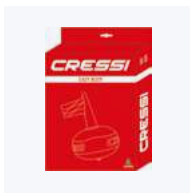

PRODUCT	CODE	DLR €	10%	SEASONAL ORDER 20%	RRP €
EASY BUOY	TA611501	18,74	16,87	14,99	29,99

# COMPETITION BUOY

BRIGHT RED COLOR FOR MAXIMUM VISIBILITY CLASSIC ROUND BUOY 0.35 MM PVC

This spherical float is slightly flattened to offer less wind resistance and has a built-in inflatable flag. Made from PVC, it has a strong anchor point for attaching the line on the lower half. It is supplied complete with a light 25 m floating line that has a small cylindrical lead weight of 150 g.

<b>Diameter</b>	30 cm - 11.81 inch
<b>Height</b>	23 cm - 9.05 inch
<b>Volume</b>	about 7 L
<b>Weight</b>	380 gr - 0.84 lb



PRODUCT	CODE	DLR €	10%	SEASONAL ORDER 20%	RRP €
COMPETITION BUOY	TA611500	18,74	16,87	14,99	29,99

# SWIM BUOY

FOLDING TOP CLOSURE INFLATION VALVE

Very hydrodynamic Swim Buoy, realized with quality materials and components. Tapered design that improves the hydrodynamics especially in case of blurred sea and wind. Red orange fluorine fabric for great visibility. Brilliant finish for an ideal slide. Internal compartment watertight with water tightness system specially effective with rigid soul. Inflator with safety closing screwing.

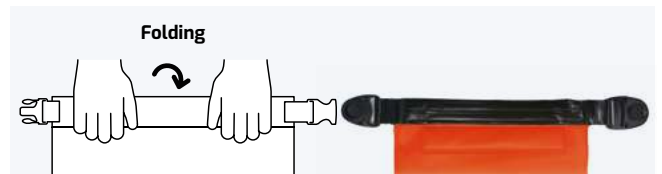

PRODUCT	CODE	DLR €	10%	SEASONAL ORDER 20%	RRP €
SWIM BUOY	TA611981	32,49	29,24	25,99	54,99

# FREEDIVING BUOY

BRIGHT RED COLOR FOR MAXIMUM VISIBILITY CLASSIC ROUND BUOY 0.35 MM PVC

This training buoy is dedicated to freediving. It has a durable external material, an external zipper pocket, four external handles for pre-immersion preparation and two exterior D-rings. The wide interior space allows to store the rope during transport. The inflation system is oral with overpressure valve. The freediving rope can be connected to a D-ring in stainless steel. Flag is included.



PRODUCT	CODE	DLR €	10%	SEASONAL ORDER 20%	RRP €
FREEDIVING TRAINING BUOY	TA611990	124.99	112.49	99.99	199.99
INNER TUBE FREEDIVING TRAINING BUOY	TZ611990	26.24	23.62	20.99	41.99



# MARKER BUOY

0.35 MM PVC

Professional balloon especially resistant due to its nylon resin-coated composition with inside polyurethane injection. It goes rolled over itself with rubber band closing and has three inflating systems: through the regulator from the inferior area, with the mouth or connecting a hose of wetsuit or jacket \*. Inside thermo welded "duck bill" to avoid accidental emptying of the balloon on surface in case of bad weather. Great visibility due to its fluorescent red color. It incorporates insertion to fix a chemical or stroboscopic light on the superior part and reflective band. Overpressure valve and quick emptying with handle. DIR snap hook. 120 cm length.



PRODUCT	CODE	DLR €	10%	SEASONAL ORDER 20%	RRP €
MARKER BUOY	TA611800	16.24	14.62	12.99	25.99



/ BALLOONS & TANKS

# HERCULES

## LIFTING BALLOON

Professional lifting balloon available in 250, 500 and 1000 kg capacity. High-strength steel rings. HD PVC laminated fabric with high frequency welding. Inflation valve and top valve. Bright color for a great visibility.

BRIGHT YELLOW COLOR FOR MAXIMUM VISIBILITY | STEEL RINGS

PRODUCT	CODE	DLR €	10%	SEASONAL ORDER 20%	RRP €
HERCULES LIFTING BALLOON kg 250	KU745002	144.99	130.49	115.99	209.99
HERCULES LIFTING BALLOON kg 500	KU745003	237.49	213.74	189.99	339.99
HERCULES LIFTING BALLOON kg 1000	KU745004	331.24	298.12	264.99	479.99
HERCULES VALVE	KZ745099	28.13	25.32	22.50	44.99



# TANKS

## STRONG AND RELIABLE TANKS

Cressi tanks are made of high quality and safety standards. They come in 5 different capacities: 5, 10, 12, 15 and 18 litres. On the other hand, the valves are made by Cressi-sub and were the first easy to assemble and disassemble valves to appear on the market. They are strong and reliable and are made from really top quality materials. The inner air passages were carefully studied in the design so as to guarantee top performance even, and above all, with the top performance regulators.

The valve design ensures an excellent grip, facilitating opening and closing of the tank. A brand new, exclusive slot system means you can check whether the faucet is open or closed at a glance (yellow = faucet closed, red = faucet open).

The regulator connection incorporates a threaded insert, which means it can equally be used for both INT bracket or DIN connection. The valves are modular you can easily change from a single connection valve to dual connection valve and vice versa. The Cressi-sub valves passed the strict tests imposed by European standards with flying colours thus receiving the prestigious CE certification.



PRODUCT	CODE	DLR €	10%	SEASONAL ORDER 20%	RRP €
CYLINDER 5lt	GB840510	287.49	258.74	229.99	399.99
CYLINDER 10lt	GB841010	331.24	298.12	264.99	459.99
CYLINDER 12lt	GB841210	399.99	359.99	319.99	549.99
CYLINDER 15lt	GB841510	431.24	388.12	344.99	589.99
CYLINDER 18lt	GB841810	462.49	416.24	369.99	629.99
BACKPACK COMPLETE 10/15/18 lt	GB840050	54.99	49.49	43.99	87.99
TEST GAUGE ARA BAR/PSI INT	KK760000	82.49	74.24	65.99	131.99
TEST GAUGE ARA BAR/PSI DIN	KK760600	82.49	74.24	65.99	131.99



### M25X2

Cressi sub uses the M25x2 spacing to thread tanks and control valves in conformity with European Regulations. Using articles (tanks/valves) with a different threading can cause serious accidents.

Backpack two-piece 10/15/18 LT

Test Gauge BAR/PSI



# BELTS & ACCESSORIES



Photo by: Kayleigh Burns & Cam Grant

/ BELTS & ACCESSORIES

# MARSEILLAISE

## PREMIUM RUBBER BELT

Rubber weight belt with stainless steel buckle. Because it is made from a stretch material, the belt automatically tightens up during descent, when it generally loosens due to abdominal pressure and the reduction in the thickness of the wetsuit. Consequently the belt always fits snugly against

the diver in every phase of the dive. The quick-release stainless steel buckle provides instinctive and rapid emergency release. The buckle pin passes through, is very strong and is riveted at both ends.



CODE	DLR €	10%	SEASONAL ORDER 20%	RRP €
TA626000	31,24	28,12	24,99	49,99

# MALTA

## QUICK RELEASE ELASTIC BELT

Rubber weight belt with Marseillaise stainless steel buckle. Because it is made from a stretch material, the belt automatically tightens up during descent, when it generally loosens due to abdominal pressure and the reduction in the thickness of the wetsuit. Consequently the belt always fits snugly against the diver in every phase of the dive. The Marseillaise stainless steel buckle has a tilting check pin that fits into the holes situated at regular intervals along the belt. Secure grip and quick emergency release.



Black



Yellow

CODE	COLOR	DLR €	10%	SEASONAL ORDER 20%	RRP €
TA626010	BLACK	28,74	25,87	22,99	44,99
XTA626011	YELLOW	28,74	25,87	22,99	44,99

# GOZO

## QUICK RELEASE NYLON BELT

Strong woven nylon weight belt, the buckle provides instinctive and rapid emergency release.



CODE	DLR €	10%	SEASONAL ORDER 20%	RRP €
TA625000	13,74	12,37	10,99	21,99

# LEAD WEIGHT

## 1 KG



CODE	DLR €	10%	SEASONAL ORDER 20%	RRP €
TA620100	11,24	10,12	8,99	17,99

# ANKLE WEIGHT

## 2 PIECES, 300 GR



CODE	DLR €	10%	SEASONAL ORDER 20%	RRP €
TA200001	37,49	33,74	29,99	59,99



## **CRESSI SPEARFISHING 2023 COLLECTION**

With this catalogue, we would like to highlight our origins, which have distinguished us over the years. Today, with the same passion as then, we follow the needs of our customers, from the beginners to the most ambitious athletes, sure of providing products suitable for all needs, always focusing on technology and results.

In these 76 years the company has always preserved its DNA, which is well represented by Cressi logo. The "C" logo with the mermaid, in the origin with the speargun, is recognisable all over the world as a prestigious brand of watersports and spearfishing.

Our goal is to provide a complete vision of our products Dedicated to all those who make spearfishing their passion.

The work undertaken over the years carries out a constant renewal of products with strict testing and always new technologies, placing us at the top for reliability, performance and durability.

All this takes in thanks to a continuous dialogue between our designers, who are always ready to make the best improvements, and our ambassadors, expert testers who have made the sea their home.

The philosophy of the Cressi family is always the same, first of all the technique and then everything else... this catalogue is an excellent example.





# BORN FROM THE SEA





**CRESSI**  
**SPEARFISHING &  
SUSTAINABILITY**

Spearfishing has become **the most sustainable fishing method** for many reasons. One of the biggest is that it has the most selective catch, by species, size, and quantity.

It also has the least problems for the environment, no by-catch, it doesn't need any bait, almost no gear loss, virtually no non-targeted species impact, and no harm to the surrounding **underwater environment**.

When using the Cressi gear and taking only high percentage shots, there is a low non-retrieval rate. **By following all fishing regulations and laws, and shooting only fish that are good to eat, and always eating your catch.**

**Cressi cares** to preserve the planet reducing its environmental impact.

**WE CARE!**





# x11 TIMES SPEARFISHING WORLD CHAMPIONS!

**CRESSI**

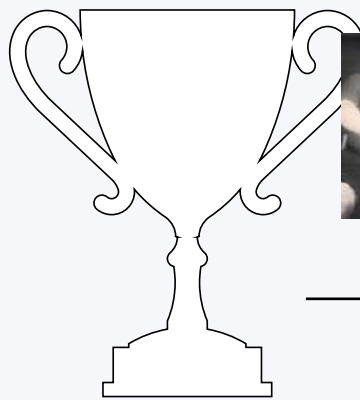

1ST WORLD SF CHAMPIONSHIP  
1957, YUGOSLAVIA



**CATALANI MARIO**  
60.140 POINTS

3RD WORLD SF CHAMPIONSHIP  
1959, MALTA



**LENTZ TERRY**  
53.050 POINTS

4TH WORLD SF CHAMPIONSHIP  
1960, ITALY



**HERMANY BRUNO**  
47.320 POINTS

6TH WORLD SF CHAMPIONSHIP  
1963, BRASIL

**HERMANY BRUNO**  
141.000 POINTS

10TH WORLD SF CHAMPIONSHIP  
1971, CHILE



**CHOQUE RAUL**  
405.550 POINTS

16TH WORLD SF CHAMPIONSHIP  
1987, TURKEY

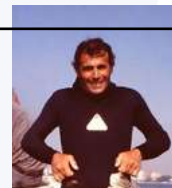

**MAZZARI RENZO**  
138.555 POINTS

17TH WORLD SF CHAMPIONSHIP  
1989, ITALY

**MAZZARI RENZO**  
64.610 POINTS

18TH WORLD SF CHAMPIONSHIP  
1992, SPAIN

**MAZZARI RENZO**  
111.296 POINTS

24TH WORLD SF CHAMPIONSHIP  
2004, CHILE



**BELLANI STEFANO**  
76.320 POINTS

27TH WORLD SF CHAMPIONSHIP  
2010, CROATIA



**DANIEL GOSPIC**  
41.484 POINTS

29TH WORLD SF CHAMPIONSHIP  
2014, PERU



**XAVIER BLANCO**  
28.191 POINTS

Egidio and Nanni Cressi first founded the Cressi company to service the growing sport of spearfishing, and the Cressi name has been associated with the sport ever since.

Cressi-sponsored athletes have **won 11 world spearfishing titles** in that time, and **15 Italian championships**.

The company offers an **extensive line of gear**. These include pneumatic and band-powered guns, masks, a lot of models of freediving fins and a wide range of accessories, such as bags, shafts, reels and so on.

# MORE THAN ANYONE ELSE!





**ANGELO ASCIONE**

Italy



**fb Angelo Ascione**

I've had several successes in both national and international spearfishing competitions. I'm a freediving and spearfishing instructor, and today I'm constantly dedicated to this. I've always been fascinated by the aquatic world. The sea is my passion which is second only to my family.

**STEFANO BELLANI**

Italy



**fb Stefano Bellani**

Since I was young, in my free time I was always out at sea, in the blue waters of Corsica, fishing tunas and amberjacks. Constantly looking for new places to explore and to practise my passion. People calls me a real champion, I'm proud to have the opportunity to share my underwater world.

**PHILIPPE CHARRIER**

France



I was born in July 1977 in Cannes, France. I am a professional fisherman. I love the sea and every time is a new discovery. In 2001 I entered the world of Cressi, which has sponsored me ever since. I was on the French national underwater fishing team between 1999 and 2005.

**CRISTIAN CORRIAS**

Italy



**fb Kristian Corrias**

I'm very connected to the sea, it gives me sense of freedom even when it's rough and seems to want to push me away. I've always had the passion for spearfishing since I was a teenager, I waited impatiently for the specialized magazines to admire the champions of the time and read their stories.

**SERGIO DE JULIÁN ARRIOLA**

Spain



**fb Sergio De Julian Arriola**

Sergio has always shown that his passion goes beyond sport or hobby, it's his way of enjoying life. A very physically prepared fisherman with an innate aquatic ability, he is an extreme competitor who performs impressive fishing rhythms at medium depths.

**LUCA DELLA SANTA**

USA



**ig lucads13**

I was raised on the beaches of North Carolina and South Florida, where my love for the ocean began. Growing up, I was fishing, diving, or surfing any chance I could get. With my love for the ocean and wanting to experience it in different ways, I have continued to share the passion for the sport.

**PEDRO DOMINGUES**

Portugal



Spearfishing for me started at the age of 14 after the death of my father, but I have been connected to the sea since I was a child, going spearfishing during my holidays in Setúbal. I like fishing for big bass, as well as bream, snapper, corvina, etc. The more difficult it gets, the more I like it.

**JULIÁN RIVAS**

Spain



**ig jrivaspq**

Member of the Spanish National Team, he started fishing in his native Asturias in the surroundings of Gijón in the Cantabrian Sea, when he was a child. He especially likes the area of Cartagena where you can find both vertical cliffs that deepen quickly as well as platform areas.

/ OUR AMBASSADORS

**NICOLÒ COLUCCELLI**



nico\_cressiteam

I love spearfishing and I compete for the Underwater Club of Sestri Levante, where I live. This year I will take part in the Italian Championships for the first time. I am honored to be part of this team, as it was my dream since I was a child. I will continue to compete hoping for the best possible results.

**DAVID GOTTSALK**



David Gottschalk

David is a passionate promoter of more responsible and selective spearfishing. He has made numerous short films available on his YouTube channel "Hasta el Fondo" on different topics such as the defence of spearfishing, learning and deep-sea fishing techniques.

**ÓSCAR HIDALGO**



Oscar Hidalgo

In his competitive career he has won 3 individual and 3 team championships in Catalonia. He became passionate about spearfishing at the age of 7; since then, his passion has not stopped growing. He is very experienced in the behaviour of fish and is a great observer of their habits.

**ÁNGEL CRUZ**



Angel Cruz

Since he was a child he used to fish with his father, at the age of 19 the sea became his whole life, his training, his profession and his sporting life. Champion of Spain 2021 and 9 times regional champion. Undoubtedly, the Cantabrian fisherman with the best career.

**ALEJANDRA PRAT**



apogonimberbis

Since she was a child her parents initiated her in the practice of spearfishing in Cap de Creus. Due to her great passion, she has made a name for herself in both men's and women's competitions, winning several titles. She's part of the Spanish national team in the next World Championship to be held in Sardinia.

**FRANCISCO LOFFREDI**



franciscoloffredi

Born and raised in Rio de Janeiro, Brazil, where I learned to fish. Spearfishing is a way of life, and my love for the sea has led me to be a proponent of sustainable spearfishing. I have won the biggest fish trophy at the Blue Water World Cup three times. In 2013, I won all three trophies of the World Cup: individual, team and biggest fish.

**FRANCESCO DIVERSI**



diversifrancesco

Graduated in Molecular Biology in Pisa, where my passion for the sea began. Particularly for sailing, achieving success in national and international competitions, and for spearfishing. In 2008 I won the Italian team championship and in 2017 I started working with Cressi.

**SANTI LÓPEZ CID**



Probably the most prestigious and recognised Spanish spearfisherman in the world. He has won 7 European Championships and 4 World Championships. He started spearfishing in Mallorca, when he found a speargun, a mask and a snorkel hidden in some bushes. Many call him "the magician" for his magical performances in championships that have left the other competitors speechless.

**DARIO MACCIONI**



dariomaccioni

Being part of the Cressi Team makes me proud, above all because since I was 8 years old my favourite brand for its colours, logo and the champions that represented it is Cressi Sub. My life is dedicated to my family and to spearfishing. I continue my competitive career giving my best with the hope that it will last as long as possible.

**RICARDO GONZÁLEZ**



Ricardo González González

Ricardo is considered an exemplary sportsman and a gentleman in every aspect of his life. In his long competitive career, he has won 8 individual Galician Championships and 3 team championships. Ricardo is a lover of the waters of Galicia and has also been a Cressi salesman for 20 years.

**PAULO MOREIRA**



I'm a Portuguese spearfisherman. I made some videos for YouTube with "MAR Y CAZA TV". I enjoy sharing this passion and also the challenge of not only catching fishes but also knowing how to capture the right moment for filming. Determination, perseverance, sacrifice: I believe that dedication strengthens talent. Also loyalty, for example to your competitors... what else? I'm always ready for ambush.

**JOÃO PEIXEIRO**



j\_peixeiro

I'm a lover of the aquatic world and I like the idea of promoting the spearfishing to break the existing taboo, to exchange knowledge and fishing techniques. I am very active on social media for this reason too, it's nice to meet people who share the same passion as you.



/ OUR AMBASSADORS

**STJEPKO KESIC**

Croatia



**Stjepko Kesic**

I'm part of the Cressi team and won my first title as Croatian National Champion in 2019. Then I won my second title in 2020, a two days championship was held in the area of half island Istra and it was organized by the Club Delfin from Pula, it was a very satisfying experience.

**ANTONINO PIRAS**

Italy



**Antonino Piras (Nino)**

When I was 12 years old the most important thing for me was to jump into the sea to see everything that was inside. I've turned this passion into my sport and I consider myself extremely lucky cause my passion has also led to my job as Cressis agent, which gives me satisfaction in being the team manager of this wonderful group of athletes.

**ANDREA SETTIMI**

Italy



**and\_set\_sea**

A lifestyle and family tradition that I have experienced since I was 12 years old. The emotions and peace that I constantly feel underwater give me the strength to look ahead and set myself new goals. I love everything about freediving, from the difficulties to the satisfaction, and I always try to learn from it. The sea seems always to understand me.

**AINHOA ABELLÁN LÓPEZ**

Spain



**Ainhoa YPunto**

She started practising it as child with her father. She has obtained good classifications, currently runner-up of Spain and she will be the main fisherwoman in the Spanish national team in the next world championship in Sardinia. She is specialised in fishing in shallow waters where she gets an amazing advantage.

**FRANCESCO PIRAS**

Italy



**pirasf**

My love for the water has been transmitted from father to son. Organising fishing expeditions is my greatest passion. I practice in all seasons and with different techniques. I live underwater all year round. In September 2016, in the waters of Taranto, I won the Italian Championship of Apnea Fishing Qualification (second category).

**ALEXANDRU TEODORESCU**

UK



**selenitry**

I'm part of Cressi Athletes team and I'm so happy to have joined this family. This cooperation allows me to practice my passion for this sport. I have the opportunity to experience and try new products all the time, this also means that I can spend as much time as possible into the water and enjoy every my spearfishing sessions.

**DAVID MONTERO**

Spain



**monterosub**

He discovered his background at the age of 14 years. He started competing in 2007 at the age of 27, achieving a third place in his debut, which encouraged him to keep trying. He is a great fisherman at medium-high depths, a very good strategist and meticulous in training for competitions.

**JUAN RAMÓN PÉREZ CABELLO**

Spain



**juanramonperezcabello**

Born a few meters from the shore of the Atlantic Ocean, Juan Ramón Pérez breathed salt water from his first breaths. A child surrounded by brothers and friends who loved spearfishing, in which he started very young. A life linked to the sea and to CRESSI, the brand he started with in 1998.

**BE THE NEXT...**



**Join the Cressi family!**

Our team is always looking for new talents and athletes who share our love for the sea!  
Contact us at:  
European countries - [marketing.italia@cressi.com](mailto:marketing.italia@cressi.com)  
American countries - [marketing@cressiusa.com](mailto:marketing@cressiusa.com)

**CRESSI**  
SPEARFISHING



OUR PARTNERS



Both partnerships comes from a patrimony of **values shared**, which have always been oriented towards the design of products tailored to users and their needs, but are also united by a genuine passion for fishing and water, the natural element in which **Mar-sea and Lowrance** electronics express their maximum efficiency.



Inflatable boats  
100% Made in Italy

 marsea\_alson



Leader in Marine  
Electronics since 1957

 lowrancefishing





# SPEARGUNS



# CHEROKEE POWER SPECIALIZED Retailer-Product

## UNLIMITED POWER

Anticorodal black frame with integrated spear guide, grip made of engineering plastic reinforced with glass fibre, interchangeable high or low soft sternal support. Ultra-light triggering case with trigger, release mechanism and line ring on the side in AISI 316, machined from solid with a CNC process. The shock absorber makes silent the release of the shaft. Reversible side-safety mechanism. Reinforced reel with steel pin buckle. Head for double elastic with magnetic spear lock: as soon as the spear is put in place, it is held by

two magnets mounted in a watertight chamber. This characteristic guarantees maximum speed of reset without the disadvantages of conventional mechanical restraint systems. The speargun is supplied with double 16 mm natural latex band, with Dyneema wishbone.

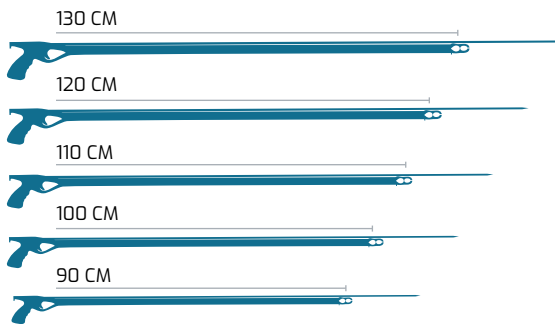

PRODUCT	CODE	DLR €	10%	SEASONAL ORDER 20%	RRP €
CHEROKEE POWER RUBBER GUN 90	FE365200	157,49	141,74	125,99	249,99
CHEROKEE POWER RUBBER GUN 100	FE365300	162,49	146,24	129,99	259,99
CHEROKEE POWER RUBBER GUN 110	FE365400	171,24	154,12	136,99	279,99
CHEROKEE POWER RUBBER GUN 120	FE365500	174,99	157,49	139,99	279,99
CHEROKEE POWER RUBBER GUN 130	FE365600	177,49	159,74	141,99	279,99



### TECHNICAL FEATURES

- Ultra light release box and trigger
- Lateral guide line release with automatic return
- Interchangeable high-low sternal support
- Shaft ø mm 7 with tig welded and drilled fins and reversed flopper
- Quick loading magnetic open muzzle
- Double circular band ø mm 16 with lined wishbone 2 mm
- Rugged barrel ø mm 28 with shaft guide



SHAFT Ø 7 MM



QUICK LOADING MAGNETIC OPEN MUZZLE

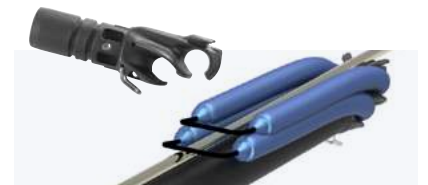

DOUBLE CIRCULAR BAND Ø 16 MM WITH LINED WISHBONE 2 MM



SHOCK ABSORBER



INTERCHANGEABLE HIGH-LOW SUPPORT



RUGGED AND REINFORCED BARREL WITH SHAFT GUIDE



SPECIAL HANDLE ANGLE TO INCREASE THE SHOT'S PRECISION



# CHEROKEE FAST

## POWERFUL WITH EASY LOADING

Anticorrosive black frame with integrated spear guide, grip made of engineering plastic reinforced with glass fibre, high or low soft sternal support. Composite material release mechanism with trigger, release tooth and lateral guide line release obtained from the base. The shock absorber makes silent the release of the shaft. Reversible side safety mechanism. Reinforced reel with steel pin

buckle. Head for double elastic with magnetic spear lock: as soon as the spear is put in place, it is held by two magnets mounted in a watertight chamber. This characteristic guarantees maximum speed of reset without the disadvantages of conventional mechanical restraint systems.

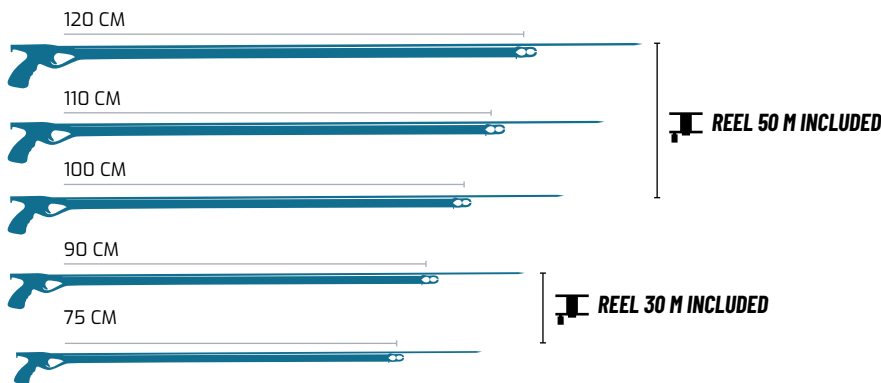

PRODUCT	CODE	DLR €	10%	SEASONAL ORDER 20%	RRP €
CHEROKEE FAST RUBBER GUN 75	FE363100	137,49	123,74	109,99	229,99
CHEROKEE FAST RUBBER GUN 90	FE363200	143,74	129,37	114,99	229,99
CHEROKEE FAST RUBBER GUN 100	FE363300	156,24	140,62	124,99	259,99
CHEROKEE FAST RUBBER GUN 110	FE363400	158,74	142,87	126,99	259,99
CHEROKEE FAST RUBBER GUN 120	FE363500	162,49	146,24	129,99	259,99

### TECHNICAL FEATURES

- Anticorrosive black barrel with integrated spear guide
- Handle made of engineering plastic reinforced with fiberglass
- Adjustable ergonomic handle, two screws allow you to set a larger or smaller handle
- Sideline release integrated into the body of the gun.
- Cobra design open-muzzle featuring softer angles for reducing friction with the bands
- Muzzle with the spear-lock system: two magnets keep the shaft in position
- Shock absorber for silencing the release of the shaft
- Reel included featuring a quick-release mounting bracket
- Choice between two sternal supports, one long and one short
- Supplied assembled, ready for use, with two elastic bands with nylon cord (Ø 14 mm) and a stainless steel shaft (Ø 6.5 mm)
- Measurements: 120, 110, 100, 90 and 75 cm



SHAFT Ø 6.5 MM



QUICK LOADING MAGNETIC OPEN MUZZLE



DOUBLE CIRCULAR BAND Ø 14 MM WITH LINED WISHBONE 2 MM



SHOCK ABSORBER

INTERCHANGEABLE HIGH-LOW SUPPORT



28 MM

RUGGED AND REINFORCED BARREL WITH SHAFT GUIDE



ULTRA LIGHT HANDLE, RELEASE BOX AND TRIGGER. LATERAL GUIDE LINE RELEASE WITH AUTOMATIC RETURN



FAST

/ SLING SPEARGUNS





# CHEROKEE EXO SPECIALIZED Retailer-Product

## MODULAR POWER

Anticorrosive black frame with integrated spear guide, grip made of engineering plastic reinforced with glass fibre, high or low sternal support. Ultra-light triggering case with trigger, release mechanism and line ring on the side in AISI 316, machined from solid with a CNC process. The shock absorber makes silent the release of the shaft. Reversible side-safety mechanism. Reinforced

reel with steel pin buckle. Head for double elastic with magnetic spear lock: as soon as the spear is put in place, it is held by two magnets mounted in a watertight chamber. This characteristic guarantees maximum speed of reset without the disadvantages of conventional mechanical restraint systems. The speargun is supplied with a 16 mm natural latex elastic, with Dyneema wishbone.

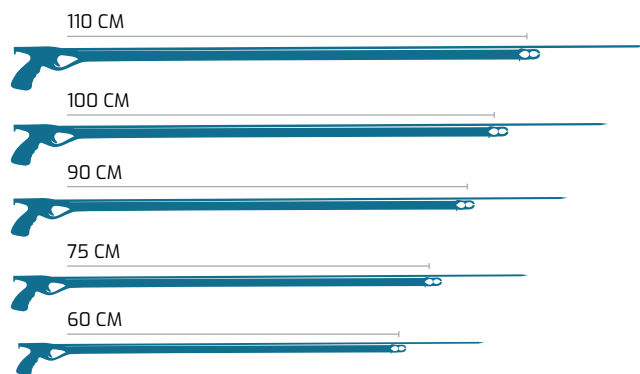

PRODUCT	CODE	DLR €	10%	SEASONAL ORDER 20%	RRP €
CHEROKEE EXO RUBBER GUN 60	FE364000	98,74	88,87	78,99	159,99
CHEROKEE EXO RUBBER GUN 75	FE364100	103,74	93,37	82,99	169,99
CHEROKEE EXO RUBBER GUN 90	FE364200	106,24	95,62	84,99	169,99
CHEROKEE EXO RUBBER GUN 100	FE364300	110,63	99,57	88,50	179,99
CHEROKEE EXO RUBBER GUN 110	FE364400	112,49	101,24	89,99	179,99

### TECHNICAL FEATURES

- Ultra light release box and trigger
- Lateral guide line release with automatic return
- Interchangeable high-low sternal support
- Interchangeable high-low sternal support
- Shaft Ø 6.5 mm
- Quick loading magnetic open muzzle
- Circular band Ø 16 mm with lined wishbone 2 mm
- Rigged barrel Ø 28 mm with shaft guide
- Measurements: 110, 100, 90, 75 and 60 cm



SHAFT Ø 6.5 MM



QUICK LOADING MAGNETIC OPEN MUZZLE



CIRCULAR BAND Ø 16 MM WITH LINED WISHBONE 2 MM



RUGGED AND REINFORCED BARREL WITH SHAFT GUIDE



INTERCHANGEABLE HIGH-LOW SUPPORT GUIDE



ULTRA LIGHT HANDLE, RELEASE BOX AND TRIGGER. LATERAL GUIDE LINE RELEASE WITH AUTOMATIC RETURN





# YUMA FAST SPECIALIZED Retailer-Product

## THE GUN FOR AMBUSH AND DEN

Anticorrosive black frame with integrated spear guide, grip made of engineering plastic reinforced with glass fibre, integrated soft sternal support. Ultra-light triggering case with release mechanism in AISI 316. Dovetail reel coupling. Head for double elastic with magnetic spear lock: as soon as the spear is put in place, it is held by two

magnets mounted in a watertight chamber. This characteristic guarantees maximum speed of reset without the disadvantages of conventional mechanical restraint systems. The speargun is supplied with double 14 mm natural latex band, with Dyneema wishbone.

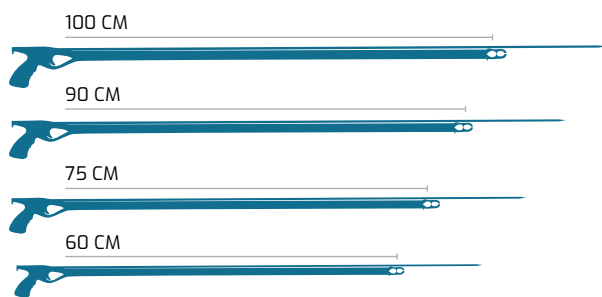

PRODUCT	CODE	DLR €	10%	SEASONAL ORDER 20%	RRP €
YUMA FAST GUN 60	FE349000	92.49	83.24	73.99	149.99
YUMA FAST GUN 75	FE349100	97.49	87.74	77.99	159.99
YUMA FAST GUN 90	FE349200	99.99	89.99	79.99	164.99
YUMA FAST GUN 100	FE349300	103.74	93.37	82.99	164.99

### TECHNICAL FEATURES

- Guide line release with automatic return
- Integrated sternal support
- Shaft  $\varnothing$  mm 6 with tig welded fins and reversed flopper
- Quick loading magnetic open muzzle
- Circular band  $\varnothing$  mm 14 with lined wishbone 2 mm
- Rigged barrel  $\varnothing$  mm 26 with shaft guide



STEEL SHAFT  $\varnothing$  6 MM



QUICK LOADING MAGNETIC OPEN MUZZLE



CIRCULAR BAND  $\varnothing$  14 MM



SHOCK ABSORBER

RUGGED AND REINFORCED BARREL WITH SHAFT GUIDE



SPECIAL HANDLE ANGLE TO INCREASE THE SHOT'S PRECISION



YUMA FAST

# MOICANO

## PERFECT FOR THE AMBUSH

Moicano is a speargun for fast fishing with its excellent handling thanks to its Ø26 mm anticorrosion aluminum barrel, with an innovative extremely rigid shaft. This combination is a great compromise between structural resilience, low production costs and ease of movement in every direction underwater. It is a very manageable, agile and multipurpose spear gun. Integrated low-friction guide as the barrel only rests on the two outer corners. The lower part is reinforced with additional thickness. This combination enables the spear gun to remain extraordinarily easy to handle while being more rigid than spear guns that are

much larger in diameter. New anatomical butt with integrated minimized load assist, derived from the legendary Apache-Comanche butt, highly resistant, reliable and appreciated by sports fishermen as a model perfect for fast fishing without problems. This proverbially ergonomic and versatile butt is suitable for every type of fishing and shooting from any position. Smooth and fast coupling of the rod and cassette mechanism, tough, reliable and compatible with all types of shafts, tolerant of different heights, finishings and machining.

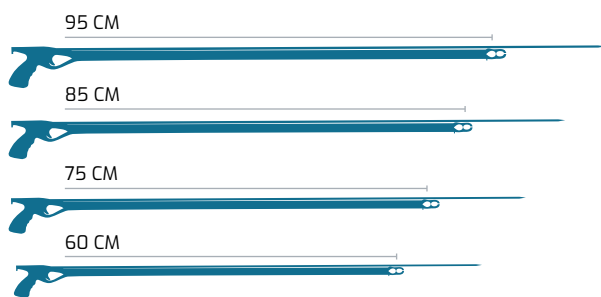

PRODUCT	CODE	DLR €	10%	SEASONAL ORDER 20%	RRP €
MOICANO RUBBER GUN 60	FE343060	92.49	83.24	73.99	149.99
MOICANO RUBBER GUN 75	FE343075	98.13	88.32	78.50	159.99
MOICANO RUBBER GUN 85	FE343085	102.49	92.24	81.99	169.99
MOICANO RUBBER GUN 95	FE343095	108.74	97.87	86.99	169.99

### TECHNICAL FEATURES

- Camouflage brown barrel
- High quality pure latex black S45 bands Ø 18 mm
- French articulated wishbone
- Shaft in 17 4 PH (AISI 630) tempered steel Ø 6 mm
- Dark top coat
- Measurements: 60, 75, 85 and 95 cm



STEEL SHAFT Ø 6 MM



ULTRA COMPACT CLOSED MUZZLE



STANDARD BAND Ø 16 MM



RUGGED AND REINFORCED BARREL WITH SHAFT GUIDE, WITH CAMOUFLAGE TREATMENT



SPECIAL HANDLE ANGLE TO INCREASE THE SHOT'S PRECISION



# COMANCHE RAIL

## THE HISTORY OF OUR SPEARGUNS

Comanche's much appreciated tried and tested grip, together with an anticorrosion aluminium frame with integrated shaft guide and the new QuickLoad mini spearhead make it the most precise and practical speargun out there, particularly for charging. The reel is attached by dovetail joint. It is possible to assemble the speargun band.

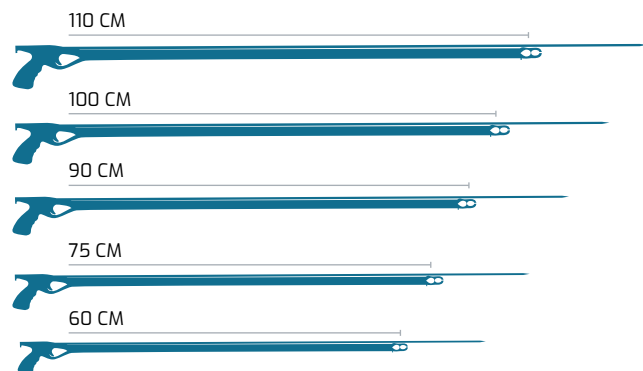

PRODUCT	CODE	DLR €	10%	SEASONAL ORDER 20%	RRP €
COMANCHE RAIL RUBBER GUN 60	FE359000	82,49	74,24	65,99	134,99
COMANCHE RAIL RUBBER GUN 75	FE359100	86,24	77,62	68,99	139,99
COMANCHE RAIL RUBBER GUN 90	FE359200	87,49	78,74	69,99	139,99
COMANCHE RAIL RUBBER GUN 100	FE359300	91,88	82,69	73,50	149,99
COMANCHE RAIL RUBBER GUN 110	FE359400	99,99	89,99	79,99	159,99

### TECHNICAL FEATURES

- Shaft in 16-4 PH tempered steel Ø 6 mm in diameter
- Dark top coat
- Measurements: 60, 75, 90, 100, 110 cm



STEEL SHAFT Ø 6 MM



ULTRA COMPACT CLOSED MUZZLE  
QUICKLOAD MINI SPEARHEAD



STANDARD BAND Ø 16 MM



RUGGED BARREL WITH SHAFT GUIDE



SPECIAL HANDLE ANGLE TO INCREASE THE SHOT'S  
PRECISION



COMANCHE RAIL



# SIoux

## BETTER EQUIPPED FIRST LEVEL GUN

Tried and tested and effective spear guns, the strengths of Sioux guns lie in the excellent materials used, their reliability, the easy firing and the favourable quality-price ratio. The barrel is made from light, non-deformable anti-corrodal aluminium. The inclination of the handgrip is designed for perfect firing and for quick, instinctive aiming; this is covered in rubbersoft. The trigger

system is very gentle and progressive, and is fitted with a safety catch. A strong ring for the line comes out of the bottom of the handgrip, and at the front there are 2 line releasing devices, the dovetail trigger for the reel and a somewhat advanced spear-rail saddle.



PRODUCT	CODE	DLR €	10%	SEASONAL ORDER 20%	RRP €
SIoux RUBBER GUN 50	FE345000	53,13	47,82	42,50	87,99
SIoux RUBBER GUN 60	FE346000	54,99	49,49	43,99	87,99
SIoux RUBBER GUN 75	FE347500	60,63	54,57	48,50	96,99

### TECHNICAL FEATURES

- The muzzle has Ø 13 mm standard bands complete with simple arched wishbones with a right ratio between loading ease and forward thrust
- The muzzle is set for possible use of a second circular band
- The Ø 6 mm diameter shaft comes with a single wing and two weapon notches
- Measurements: 75, 60 and 50 cm

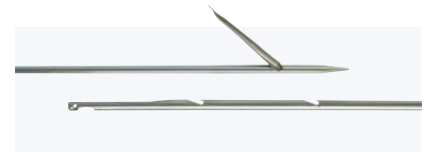

STEEL SHAFT Ø 6.5 MM



ULTRA COMPACT CLOSED MUZZLE  
QUICKLOAD MINI SPEARHEAD



STANDARD BAND Ø 13 MM



BARREL MADE FROM NON-DEFORMABLE ALUMINIUM



SPECIAL HANDLE ANGLE TO INCREASE THE SHOT'S PRECISION



SIoux

# APACHE

## ROBUST AND MINIMALIST

Simplified version of the Navajo model. Open head, robust and minimalist, to optimize the visibility of the shaft. It is a spear gun of competition range, but also adapted to non-professional underwater fishermen, for the incorporation of basic accessories. Anodised aluminium tube 26 mm in diameter.

High resistance to flexion once the rubbers have been tensioned, with the consequent increase in precision. Speargun that stands out for its perfect stability and compensation due to the distribution of weights. 6 mm diameter steel shaft.

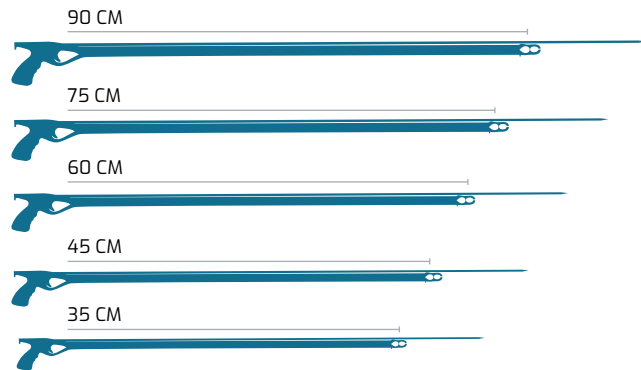

PRODUCT	CODE	DLR €	10%	SEASONAL ORDER 20%	RRP €
APACHE RUBBER GUN 35	FE341035	43,74	39,37	34,99	75,99
APACHE RUBBER GUN 45	FE341045	46,24	41,62	36,99	75,99
APACHE RUBBER GUN 60	FE341060	48,13	43,32	38,50	75,99
APACHE RUBBER GUN 75	FE341075	51,88	46,69	41,50	89,99
APACHE RUBBER GUN 90	FE341090	56,24	50,62	44,99	89,99



NEW THREADED TIP  
SHAFT Ø 7 MM



OPEN MUZZLE



CIRCULAR BAND Ø 13 MM



BARREL Ø 26 MM



SPECIAL HANDLE ANGLE TO INCREASE THE SHOT'S PRECISION



APACHE

# SAETTA SPECIALIZED

Retailer-Product

## QUALITY & POWER

The Saetta black is the ultimate in pneumatic spearguns. An upgraded model of the world-renowned Cressi SL series, The Saetta offers unmatched power, comfort and accuracy. A few design tweaks have been able to maximize shot power with high precision and speed. Among the upgrades of the extremely reliably SL series is a new muzzle with incorporated holes to aid in water drainage and a new, soft, angled white handle that also aids in locating the speargun underwater. The Saetta still boasts some of the same

successful features of its predecessors. For one, an anatomical high grip butt that enables the gun to be held in line with the arm. A strong line hook situated on the bottom of the grip butt for shaft loading. Also, a safety catch that frees the line; releasing the device, when the trigger is pulled, and lastly, an Ø 8 mm threaded shaft. The Cressi Saetta is the new standard in pneumatic spearguns. The Saetta is available also with the version with the Power Reducer, a lever that reduces the power of the half, in case of close targets.

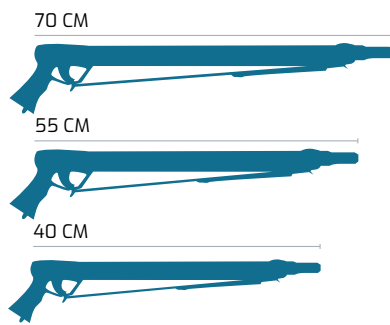
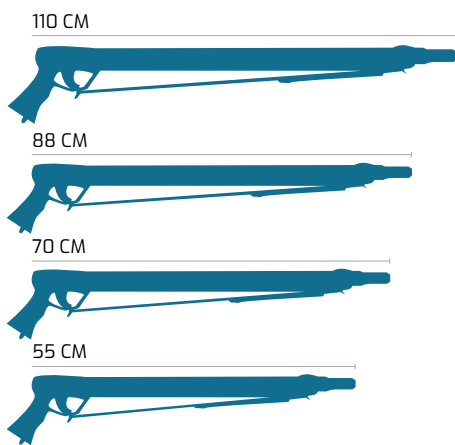

PRODUCT	CODE	DLR €	10%	SEASONAL ORDER 20%	RRP €
SAETTA PNEUMATIC GUN W/REDUCER 55	FS385500	114,99	103,49	91,99	184,99
SAETTA PNEUMATIC GUN W/REDUCER 70	FS387000	123,13	110,82	98,50	194,99
SAETTA PNEUMATIC GUN W/REDUCER 88	FS388800	129,99	116,99	103,99	209,99
SAETTA PNEUMATIC GUN W/REDUCER 110	FS389910	142,49	128,24	113,99	229,99

PRODUCT	CODE	DLR €	10%	SEASONAL ORDER 20%	RRP €
SAETTA PNEUMATIC GUN 40	FR384000	93,74	84,37	74,99	149,99
SAETTA PNEUMATIC GUN 55	FR385500	99,99	89,99	79,99	159,99
SAETTA PNEUMATIC GUN 70	FR387000	109,99	98,99	87,99	169,99

### TECHNICAL FEATURES

- Internal Ø 13 mm barrel
- Upgraded muzzle with incorporated holes for water drainage
- Upgraded white-colored ergonomic handle
- Safety lock
- Handle eyelet for cord connection
- Threaded shaft Ø 8.0 mm
- Power reducer version available
- Measurements: 70, 55 and 40 cm
- Measurements with reducer: 110, 88, 70 and 55 cm

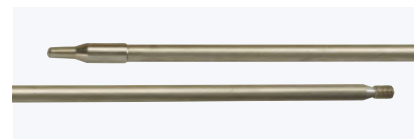

SHAFT Ø MM 8



INT. BARREL Ø 13MM



SIGHT LINE

SPEAR CENTER LINE



OFFSET BARREL



WITH POWER REDUCER





# SL STAR

NEW DESIGN 2023

## THE HISTORY OF OUR PNEUMATIC GUNS

The SL Star range of pneumatic spear guns has been in production for many years now, and they have won worldwide fame for their excellence in terms of robustness, reliability, precision and powerful shooting. The various models correspond to the equivalent models in the SL series, without power reducer. Constantly updated over the years,

the SL Star spear guns are ultra light, easy to use, and fire quickly. They come with anatomical high grip butts enabling the gun to be held in line with the arm with no extra effort. The bright red butt means you can identify the gun even if it ends up on the sea-bottom after shooting.

### TECHNICAL FEATURES

- A strong line hook is situated on the bottom of the butt for shaft loading
- The guns are fitted with a safety catch and, when the trigger is pulled, it frees the line releasing device
- The SL Star spear guns come with an Ø 8 mm threaded steel shaft
- Measurements: 70, 55 and 40 cm

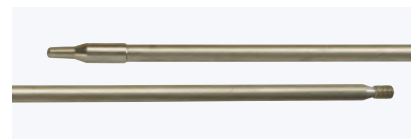
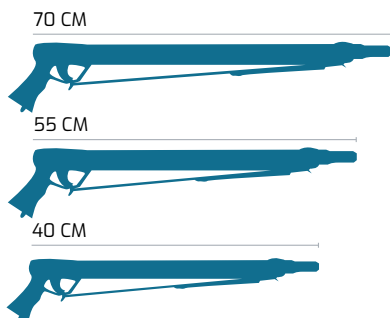

SHAFT Ø MM 8



INT. BARREL Ø 13MM



OFFSET BARREL

PRODUCT	CODE	DLR €	10%	SEASONAL ORDER 20%	RRP €
SL/STAR PNEUMATIC GUN 40	FR374000	91,24	82,12	72,99	144,99
SL/STAR PNEUMATIC GUN 55	FR375500	96,24	86,62	76,99	152,99
SL/STAR PNEUMATIC GUN 70	FR377000	103,74	93,37	82,99	164,99



# SL STAR

/ SPEARGUNS COMPARISON TABLE

			GUN DETAILS										MATERIAL
			OVERALL LENGTH cm - in	POWER LENGTH cm - in	BARRELL Ø mm	SHOT RANGE m - ft	READY TO USE	SHOCK ABSORBER INCLUDED	MUZZLE TYPE	LINE LOOP			
RUBBER SPEARGUN													
	CHEROKEE POWER RUBBER GUN 100	138 54.3	104 40.9	28	6.9 22.7	NO	YES	2X CIRCULAR BAND MUZZLE	2	17-4 PH STAINLESS STEEL			
	CHEROKEE POWER RUBBER GUN 110	148 58.2	114 44.8	28	7.4 24.3	NO	YES	2X CIRCULAR BAND MUZZLE	2	17-4 PH STAINLESS STEEL			
	CHEROKEE POWER RUBBER GUN 120	158 62.2	124 48.8	28	7.8 25.8	NO	YES	2X CIRCULAR BAND MUZZLE	2	17-4 PH STAINLESS STEEL			
	CHEROKEE POWER RUBBER GUN 130	168 66.1	134 52.7	28	8.3 27.4	NO	YES	2X CIRCULAR BAND MUZZLE	2	17-4 PH STAINLESS STEEL			
	CHEROKEE FAST RUBBER GUN 75	113 44.4	79 31.1	28	5.5 18.1	NO	YES	2X CIRCULAR BAND MUZZLE	1	17-4 PH STAINLESS STEEL			
	CHEROKEE FAST RUBBER GUN 90	128 50.3	94 37.0	28	6.2 20.3	NO	YES	2X CIRCULAR BAND MUZZLE	1	17-4 PH STAINLESS STEEL			
	CHEROKEE FAST RUBBER GUN 100	138 54.3	104 40.9	28	6.6 21.8	NO	YES	2X CIRCULAR BAND MUZZLE	1	17-4 PH STAINLESS STEEL			
	CHEROKEE FAST RUBBER GUN 110	148 58.2	114 44.8	28	7.1 23.3	NO	YES	2X CIRCULAR BAND MUZZLE	1	17-4 PH STAINLESS STEEL			
	CHEROKEE FAST RUBBER GUN 120	158 62.2	124 48.8	28	7.5 24.9	NO	YES	2X CIRCULAR BAND MUZZLE	1	17-4 PH STAINLESS STEEL			
	CHEROKEE EXO RUBBER GUN 60	98 38.5	64 25.1	28	4.5 14.9	NO	YES	2X CIRCULAR BAND MUZZLE	1	17-4 PH STAINLESS STEEL			
	CHEROKEE EXO RUBBER GUN 75	113 44.4	79 31.1	28	5.2 17.0	NO	YES	2X CIRCULAR BAND MUZZLE	1	17-4 PH STAINLESS STEEL			
	CHEROKEE EXO RUBBER GUN 90	128 50.3	94 37.0	28	5.8 19.1	NO	YES	2X CIRCULAR BAND MUZZLE	1	17-4 PH STAINLESS STEEL			
	CHEROKEE EXO RUBBER GUN 100	138 54.3	104 40.9	28	6.2 20.6	NO	YES	2X CIRCULAR BAND MUZZLE	1	17-4 PH STAINLESS STEEL			
	CHEROKEE EXO RUBBER GUN 110	148 58.2	114 44.8	28	6.7 22.0	NO	YES	2X CIRCULAR BAND MUZZLE	1	17-4 PH STAINLESS STEEL			
	COMANCHE RAIL RUBBER GUN 60	102 40.1	60 23.6	28	4.3 14.1	YES	NO	1X PARALLEL + 1X CIRCULAR BAND MUZZLE	1	17-4 PH STAINLESS STEEL			
	COMANCHE RAIL RUBBER GUN 75	127 50.0	75 29.5	28	5.3 17.4	YES	NO	1X PARALLEL + 1X CIRCULAR BAND MUZZLE	1	17-4 PH STAINLESS STEEL			
	COMANCHE RAIL RUBBER GUN 90	142 55.9	90 35.4	28	5.9 19.4	YES	NO	1X PARALLEL + 1X CIRCULAR BAND MUZZLE	1	17-4 PH STAINLESS STEEL			
	COMANCHE RAIL RUBBER GUN 100	152 59.8	100 39.3	28	6.3 20.7	YES	NO	1X PARALLEL + 1X CIRCULAR BAND MUZZLE	1	17-4 PH STAINLESS STEEL			
	COMANCHE RAIL RUBBER GUN 110	162 63.7	110 43.3	28	6.7 22.0	YES	NO	1X PARALLEL + 1X CIRCULAR BAND MUZZLE	1	17-4 PH STAINLESS STEEL			
	MOICANO RUBBER GUN 60	102 40.1	58 22.8	26	4.3 14.1	YES	NO	1X PARALLEL + 1X CIRCULAR BAND MUZZLE	1	17-4 PH STAINLESS STEEL			
	MOICANO RUBBER GUN 75	117 46.0	73 28.7	26	4.9 16.1	YES	NO	1X PARALLEL + 1X CIRCULAR BAND MUZZLE	1	17-4 PH STAINLESS STEEL			
	MOICANO RUBBER GUN 85	127 50.0	83 32.6	26	5.3 17.4	YES	NO	1X PARALLEL + 1X CIRCULAR BAND MUZZLE	1	17-4 PH STAINLESS STEEL			
	MOICANO RUBBER GUN 95	137 53.9	93 36.6	26	5.7 18.7	YES	NO	1X PARALLEL + 1X CIRCULAR BAND MUZZLE	1	17-4 PH STAINLESS STEEL			
	YUMA FAST GUN 60	102 40.1	64 25.1	26	4.3 14.1	NO	YES	2X CIRCULAR BAND MUZZLE	1	17-4 PH STAINLESS STEEL			
	YUMA FAST GUN 75	117 46.0	79 31.1	26	4.9 16.1	NO	YES	2X CIRCULAR BAND MUZZLE	1	17-4 PH STAINLESS STEEL			
	YUMA FAST GUN 90	132 51.9	94 37.0	26	5.5 18.1	NO	YES	2X CIRCULAR BAND MUZZLE	1	17-4 PH STAINLESS STEEL			
	YUMA FAST GUN 100	142 55.9	104 40.9	26	5.9 19.4	NO	YES	2X CIRCULAR BAND MUZZLE	1	17-4 PH STAINLESS STEEL			
	SIoux RUBBER GUN 50	87 34.2	50 19.6	28	3.4 11.4	NO	NO	1X PARALLEL + 1X CIRCULAR BAND MUZZLE	1	PR80 GALVANIZED SPRING			
	SIoux RUBBER GUN 60	102 40.1	60 23.6	28	4.0 13.2	NO	NO	1X PARALLEL + 1X CIRCULAR BAND MUZZLE	1	PR80 GALVANIZED SPRING			
	SIoux RUBBER GUN 75	117 46.0	75 29.5	28	4.6 15.1	NO	NO	1X PARALLEL + 1X CIRCULAR BAND MUZZLE	1	PR80 GALVANIZED SPRING			
	APACHE RUBBER GUN 35	67 26.3	30 11.8	28	3.0 10.1	NO	NO	1X CIRCULAR BAND MUZZLE	1	PR80 GALVANIZED SPRING			
	APACHE RUBBER GUN 45	77 30.3	40 15.7	28	3.4 11.3	NO	NO	1X CIRCULAR BAND MUZZLE	1	PR80 GALVANIZED SPRING			
	APACHE RUBBER GUN 60	87 34.2	55 21.6	28	3.8 12.6	NO	NO	1X CIRCULAR BAND MUZZLE	1	PR80 GALVANIZED SPRING			
	APACHE RUBBER GUN 75	102 40.1	70 27.5	28	4.4 14.5	NO	NO	1X CIRCULAR BAND MUZZLE	1	PR80 GALVANIZED SPRING			
	APACHE RUBBER GUN 90	117 46.0	85 33.4	28	4.9 16.3	NO	NO	1X CIRCULAR BAND MUZZLE	1	PR80 GALVANIZED SPRING			

			GUN DETAILS					
			READY TO USE SET	SHOCK ABSORBER INCLUDED	SHOT RANGE m - ft	TOTAL LENGTH GUN + SPEAR cm	BARREL DIAMETER mm	LINE LOOP
PNEUMATIC SPEARGUN								
	SAETTA PNEUMATIC GUN 40	NO	NO	2.4	7.9	70	13	2
	SAETTA PNEUMATIC GUN 55	NO	NO	3.0	9.8	85	13	2
	SAETTA PNEUMATIC GUN 70	NO	NO	3.4	11.4	100	13	2
	SAETTA PNEUMATIC GUN W/REDUCER 55	NO	NO	3.0	9.8	85	13	2
	SAETTA PNEUMATIC GUN W/REDUCER 70	NO	NO	3.4	11.4	100	13	2
	SAETTA PNEUMATIC GUN W/REDUCER 88	NO	NO	4.1	13.5	118	13	2
	SAETTA PNEUMATIC GUN W/REDUCER 110	NO	NO	4.8	15.9	140	13	2
	SL/STAR PNEUMATIC GUN 40	NO	NO	2.2	7.3	70	13	2
	SL/STAR PNEUMATIC GUN 55	NO	NO	2.7	9.0	85	13	2
	SL/STAR PNEUMATIC GUN 70	NO	NO	3.1	10.4	100	13	2

SHAFT DETAILS								POWER BAND DETAILS						
Ø mm	LENGTH cm	FLOPPER TYPE	TAB N°	TAB TYPE	REST TAB	POINT TYPE	COMPATIBLE SHAFTS Ø RANGE mm	COMPATIBLE SHAFTS LENGTHS RANGE cm	N°	TYPE	MATERIAL	Ø mm	LENGTH mm	WISHBONE
7	130	BOTTOM FLOPPER	2	LARGE SHARKFIN	YES	PIN POINT	FROM 6 TO 7	130/145	2X	CIRCULAR	DIPPED NATURAL RUBBER LATEX	16	63	DYNEEMA® SK78
7	140	BOTTOM FLOPPER	2	LARGE SHARKFIN	YES	PIN POINT	FROM 6 TO 7	140/155	2X	CIRCULAR	DIPPED NATURAL RUBBER LATEX	16	69.5	DYNEEMA® SK78
7	150	BOTTOM FLOPPER	2	LARGE SHARKFIN	YES	PIN POINT	FROM 6 TO 7	150/165	2X	CIRCULAR	DIPPED NATURAL RUBBER LATEX	16	77	DYNEEMA® SK78
7	160	BOTTOM FLOPPER	2	LARGE SHARKFIN	YES	PIN POINT	FROM 6 TO 7	160/175	2X	CIRCULAR	DIPPED NATURAL RUBBER LATEX	16	83	DYNEEMA® SK78
6.5	105	BOTTOM FLOPPER	2	MINI SHARKFIN	NO	PIN POINT	FROM 6 TO 7	105/120	2X	CIRCULAR	DIPPED NATURAL RUBBER LATEX	14	48	DYNEEMA® SK78
6.5	120	BOTTOM FLOPPER	2	MINI SHARKFIN	YES	PIN POINT	FROM 6 TO 7	120/135	2X	CIRCULAR	DIPPED NATURAL RUBBER LATEX	14	57	DYNEEMA® SK78
6.5	130	BOTTOM FLOPPER	2	MINI SHARKFIN	YES	PIN POINT	FROM 6 TO 7	130/145	2X	CIRCULAR	DIPPED NATURAL RUBBER LATEX	14	63	DYNEEMA® SK78
6.5	140	BOTTOM FLOPPER	2	MINI SHARKFIN	YES	PIN POINT	FROM 6 TO 7	140/155	2X	CIRCULAR	DIPPED NATURAL RUBBER LATEX	14	69.5	DYNEEMA® SK78
6.5	150	BOTTOM FLOPPER	2	MINI SHARKFIN	YES	PIN POINT	FROM 6 TO 7	150/165	2X	CIRCULAR	DIPPED NATURAL RUBBER LATEX	14	77	DYNEEMA® SK78
6.5	90	BOTTOM FLOPPER	2	MINI SHARKFIN	NO	PIN POINT	FROM 6 TO 7	90/105	1X	CIRCULAR	DIPPED NATURAL RUBBER LATEX	16	39	DYNEEMA® SK78
6.5	105	BOTTOM FLOPPER	2	MINI SHARKFIN	NO	PIN POINT	FROM 6 TO 7	105/120	1X	CIRCULAR	DIPPED NATURAL RUBBER LATEX	16	48	DYNEEMA® SK78
6.5	120	BOTTOM FLOPPER	2	MINI SHARKFIN	YES	PIN POINT	FROM 6 TO 7	120/135	1X	CIRCULAR	DIPPED NATURAL RUBBER LATEX	16	57	DYNEEMA® SK78
6.5	130	BOTTOM FLOPPER	2	MINI SHARKFIN	YES	PIN POINT	FROM 6 TO 7	130/145	1X	CIRCULAR	DIPPED NATURAL RUBBER LATEX	16	63	DYNEEMA® SK78
6.5	140	BOTTOM FLOPPER	2	MINI SHARKFIN	YES	PIN POINT	FROM 6 TO 7	140/155	1X	CIRCULAR	DIPPED NATURAL RUBBER LATEX	16	69.5	DYNEEMA® SK78
6	90	TOP FLOPPER	2	SMOOTH NOTCH	NO	PIN POINT	FROM 6 TO 7	90-105	1X	PARALLEL	SYNTHETIC	16	16	JOINTED-WISHBONE
6	115	TOP FLOPPER	2	SMOOTH NOTCH	NO	PIN POINT	FROM 6 TO 7	105-120	1X	PARALLEL	SYNTHETIC	16	18.5	JOINTED-WISHBONE
6	130	TOP FLOPPER	2	SMOOTH NOTCH	YES	PIN POINT	FROM 6 TO 7	120-135	1X	PARALLEL	SYNTHETIC	16	22	JOINTED-WISHBONE
6	140	TOP FLOPPER	2	SMOOTH NOTCH	YES	PIN POINT	FROM 6 TO 7	130-145	1X	PARALLEL	SYNTHETIC	16	25.5	JOINTED-WISHBONE
6	150	TOP FLOPPER	2	SMOOTH NOTCH	YES	PIN POINT	FROM 6 TO 7	140-155	1X	PARALLEL	SYNTHETIC	16	27.5	JOINTED-WISHBONE
6	90	TOP FLOPPER	2	SMOOTH NOTCH	NO	PIN POINT	UP TO 6	90-95	1X	PARALLEL	SYNTHETIC	16	16	JOINTED-WISHBONE
6	105	TOP FLOPPER	2	SMOOTH NOTCH	NO	PIN POINT	UP TO 6	105-110	1X	PARALLEL	SYNTHETIC	16	18.5	JOINTED-WISHBONE
6	115	TOP FLOPPER	2	SMOOTH NOTCH	NO	PIN POINT	UP TO 6	115-120	1X	PARALLEL	SYNTHETIC	16	20	JOINTED-WISHBONE
6	125	TOP FLOPPER	2	SMOOTH NOTCH	YES	PIN POINT	UP TO 6	125-130	1X	PARALLEL	SYNTHETIC	16	22	JOINTED-WISHBONE
6	90	BOTTOM FLOPPER	2	MINI SHARKFIN	NO	PIN POINT	UP TO 6	90-95	1X	CIRCULAR	DIPPED NATURAL RUBBER LATEX	14	39	DYNEEMA® SK78
6	105	BOTTOM FLOPPER	2	MINI SHARKFIN	NO	PIN POINT	UP TO 6	105-110	1X	CIRCULAR	DIPPED NATURAL RUBBER LATEX	14	48	DYNEEMA® SK78
6	120	BOTTOM FLOPPER	2	MINI SHARKFIN	YES	PIN POINT	UP TO 6	120-125	1X	CIRCULAR	DIPPED NATURAL RUBBER LATEX	14	57	DYNEEMA® SK78
6	130	BOTTOM FLOPPER	2	MINI SHARKFIN	YES	PIN POINT	UP TO 6	130-135	1X	CIRCULAR	DIPPED NATURAL RUBBER LATEX	14	63	DYNEEMA® SK78
6.5	75	TOP FLOPPER	2	SHARP NOTCH	NO	PIN POINT	FROM 6 TO 7	75-85	1X	PARALLEL	SYNTHETIC	13	13	STANDARD-WISHBONE
6.5	90	TOP FLOPPER	2	SHARP NOTCH	NO	PIN POINT	FROM 6 TO 7	90-100	1X	PARALLEL	SYNTHETIC	13	17	STANDARD-WISHBONE
6.5	105	TOP FLOPPER	2	SHARP NOTCH	NO	PIN POINT	FROM 6 TO 7	105-110	1X	PARALLEL	SYNTHETIC	13	24	STANDARD-WISHBONE
7	65	THREAD SPEAR FLOPPER	2	SHARP NOTCH	NO	PIN POINT	FROM 6 TO 7	-	1X	CIRCULAR	SYNTHETIC	13	24	STANDARD-WISHBONE
7	75	THREAD SPEAR FLOPPER	2	SHARP NOTCH	NO	PIN POINT	FROM 6 TO 7	-	1X	CIRCULAR	SYNTHETIC	13	31	STANDARD-WISHBONE
7	85	THREAD SPEAR FLOPPER	2	SHARP NOTCH	NO	PIN POINT	FROM 6 TO 7	-	1X	CIRCULAR	SYNTHETIC	13	34	STANDARD-WISHBONE
7	100	THREAD SPEAR FLOPPER	2	SHARP NOTCH	NO	PIN POINT	FROM 6 TO 7	-	1X	CIRCULAR	SYNTHETIC	13	39	STANDARD-WISHBONE
7	115	THREAD SPEAR FLOPPER	2	SHARP NOTCH	NO	PIN POINT	FROM 6 TO 7	-	1X	CIRCULAR	SYNTHETIC	13	44	STANDARD-WISHBONE

EASIER LOADING PRESSURE		STANDARD PRESSURE		HARDER LOADING PRESSURE		SHAFT DETAILS					
BAR	PSI	BAR	PSI	BAR	PSI	MATERIAL	DIAMETER mm	LENGTH cm	FLOPPER TYPE	POINT TYPE	INCLUDED SHAFT SKU
16	232	18	261	24	348	PR80 GALVANIZED SPRING	8.0	36.5 (+10)	THREAD SPEAR FLOPPER	PIN POINT	FA360036
16	232	18	261	24	348	PR80 GALVANIZED SPRING	8.0	55.0 (+10)	THREAD SPEAR FLOPPER	PIN POINT	FA361036
16	232	18	261	24	348	PR80 GALVANIZED SPRING	8.0	68.5 (+10)	THREAD SPEAR FLOPPER	PIN POINT	FA362036
16	232	18	261	24	348	PR80 GALVANIZED SPRING	8.0	55.0 (+10)	THREAD SPEAR FLOPPER	PIN POINT	FA361036
16	232	18	261	24	348	PR80 GALVANIZED SPRING	8.0	68.5 (+10)	THREAD SPEAR FLOPPER	PIN POINT	FA362036
16	232	18	261	24	348	PR80 GALVANIZED SPRING	8.0	87.5 (+10)	THREAD SPEAR FLOPPER	PIN POINT	FA363036
16	232	18	261	24	348	PR80 GALVANIZED SPRING	8.0	109.5 (+10)	THREAD SPEAR FLOPPER	PIN POINT	FA366036
16	232	18	261	24	348	PR80 GALVANIZED SPRING	8.0	36.5 (+10)	THREAD SPEAR FLOPPER	PIN POINT	FA360036
16	232	18	261	24	348	PR80 GALVANIZED SPRING	8.0	55.0 (+10)	THREAD SPEAR FLOPPER	PIN POINT	FA361036
16	232	18	261	24	348	PR80 GALVANIZED SPRING	8.0	68.5 (+10)	THREAD SPEAR FLOPPER	PIN POINT	FA362036



## SAETTA

MAIN SPARE PARTS



PRODUCT	CODE	DLR €	10%	SEAS. ORDER 20%	RRP €
PISTON COMPLETE	FZ370096	9,99	8,99	7,99	15,99
PRELOAD. VALVE CAP	FZ370087	5,63	5,07	4,50	8,99
COMPLETE MUZZLE	FZ370097	19,99	17,99	15,99	31,99
COMP. LINE SLIDER	FZ370079	8,13	7,32	6,50	12,99
SAFETY CATCH	FZ370078	4,99	4,49	3,99	7,99

## SL STAR

MAIN SPARE PARTS



PRODUCT	CODE	DLR €	10%	SEAS. ORDER 20%	RRP €
PISTON COMPLETE (TEFLON)	FZ360072	9,38	8,44	7,50	14,99
PRELOAD. VALVE CAP	FZ360088	4,38	3,94	3,50	6,99
COMPLETE MUZZLE	FZ360070	14,38	12,94	11,50	22,99
SIGHT + COMPLETE MUZZLE	FZ360028	18,13	16,32	14,50	28,99
COMPLETE LINE SLIDER	FZ360093	7,49	6,74	5,99	11,99
SAFETY CATCH	FZ360025	4,38	3,94	3,50	6,99
TEFLON SHOCK ABSORBER	FZ360004	4,38	3,94	3,50	6,99

## S45 PLUS CIRCULAR

18 MM DIAMETER



CODE	GUN	SIZE	MM	DLR €	10%	SEASONAL ORDER 20%	RRP €
FA400103	75	45cm	18	24,38	21,94	19,50	38,99
FA400104	85-90	50cm	18	24,38	21,94	19,50	38,99
FA400105	95-100	55cm	18	24,38	21,94	19,50	38,99
FA400106	105-110	62cm	18	24,38	21,94	19,50	38,99
FA400107	115-120	70cm	18	24,38	21,94	19,50	38,99

## S45 PLUS CIRCULAR LW

18 MM DIAMETER WITH LINED WISHBONE



CODE	GUN	SIZE	MM	DLR €	10%	SEASONAL ORDER 20%	RRP €
FA400113	75	48cm	18	26,24	23,62	20,99	41,99
FA400114	85-90	57cm	18	26,24	23,62	20,99	41,99
FA400115	95-100	63cm	18	26,24	23,62	20,99	41,99
FA400116	105-110	69,5cm	18	26,24	23,62	20,99	41,99

## S40 CIRCULAR

13 MM DIAMETER



CODE	GUN	SIZE	MM	DLR €	10%	SEASONAL ORDER 20%	RRP €
FA340019	35	24cm	13	11,24	10,12	8,99	17,99
FA340020	50	31cm	13	11,24	10,12	8,99	17,99
FA340021	60	34cm	13	11,24	10,12	8,99	17,99
FA340022	75	39cm	13	11,24	10,12	8,99	17,99
FA340023	90	44cm	13	11,24	10,12	8,99	17,99

## S45 PLUS

18 MM DIAMETER



CODE	GUN	SIZE	MM	DLR €	10%	SEASONAL ORDER 20%	RRP €
FA400021	45-50	14cm	18	22,49	20,24	17,99	35,99
FA400022	55-60	16cm	18	22,49	20,24	17,99	35,99
FA400023	75	18,5cm	18	22,49	20,24	17,99	35,99
FA400025	85-90	22cm	18	22,49	20,24	17,99	35,99
FA400026	95-100	25,5cm	18	22,49	20,24	17,99	35,99
FA400027	105-110	27,5cm	18	22,49	20,24	17,99	35,99

## S40

16 MM DIAMETER



CODE	GUN	SIZE	MM	DLR €	10%	SEASONAL ORDER 20%	RRP €
FA400001	45-50	14cm	16	16,24	14,62	12,99	25,99
FA400002	55-60	16cm	16	16,24	14,62	12,99	25,99
FA400003	75	18,5cm	16	16,24	14,62	12,99	25,99
FA400004	82-84	20cm	16	16,88	15,19	13,50	26,99
FA400005	85-90	22cm	16	16,88	15,19	13,50	26,99
FA400006	95-100	25,5cm	16	16,88	15,19	13,50	26,99
FA400007	105-110	27,5cm	16	16,88	15,19	13,50	26,99

## STANDARD

13 MM DIAMETER



CODE	GUN	SIZE	MM	DLR €	10%	SEASONAL ORDER 20%	RRP €
FA340006	50	13cm	13	11,24	10,12	8,99	17,99
FA340007	60	17cm	13	11,24	10,12	8,99	17,99
FA340008	75	24cm	13	11,24	10,12	8,99	17,99

/ RUBBER BANDS

### PURE BLACK

14 MM DIAMETER



Reinforced internal tube, bigger density (shore 45°) to maximize the resistance to pressure of the ball over the internal walls of the rubber.

CODE	SIZE	MM	DLR €	10%	SEASONAL ORDER 20%	RRP €
FB031450	3 mt	14mm	43,13	38,82	34,50	68,99

### PURE BLUE

16 MM DIAMETER



Reinforced internal tube, bigger density (shore 45°) to maximize the resistance to pressure of the ball over the internal walls of the rubber.

CODE	SIZE	MM	DLR €	10%	SEASONAL ORDER 20%	RRP €
FB031620	3 mt	16mm	45,63	41,07	36,50	72,99

### PURE RED

14 MM DIAMETER



Reinforced internal tube, bigger density (shore 45°) to maximize the resistance to pressure of the ball over the internal walls of the rubber.

CODE	SIZE	MM	DLR €	10%	SEASONAL ORDER 20%	RRP €
FB031480	3 mt	14mm	43,13	38,82	34,50	68,99

### PURE GREEN

16 MM DIAMETER

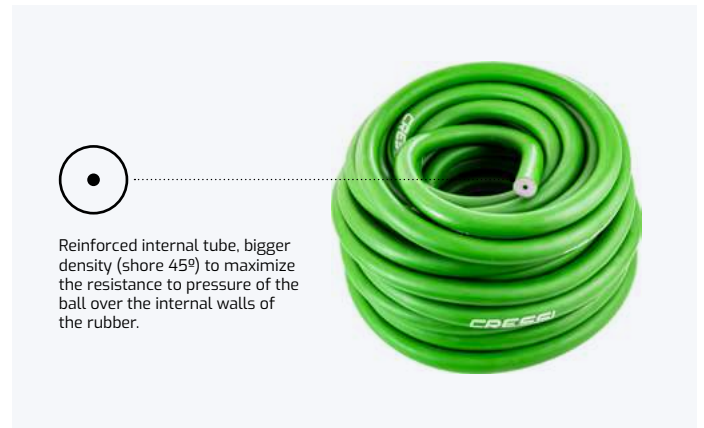

Reinforced internal tube, bigger density (shore 45°) to maximize the resistance to pressure of the ball over the internal walls of the rubber.

CODE	SIZE	MM	DLR €	10%	SEASONAL ORDER 20%	RRP €
FB031690	3 mt	16mm	45,63	41,07	36,50	72,99



HOW-TO VIDEOS on:  
[YouTube](#)  
[vimeo](#)

# KRAKEN

## SLING GUN SHAFT: 17-4 PH FINNED BOTTOM FLOP



PRODUCT	CODE	SIZE	Ø	DLR €	10%	SEASONAL ORDER 20%	RRP €
KRAKEN SHAFT BOTTOM FLOP	FA406120	120 cm	7 mm	39,99	35,99	31,99	63,99
KRAKEN SHAFT BOTTOM FLOP	FA406130	130 cm	7 mm	39,99	35,99	31,99	63,99
KRAKEN SHAFT BOTTOM FLOP	FA406140	140 cm	7 mm	39,99	35,99	31,99	63,99
KRAKEN SHAFT BOTTOM FLOP	FA406150	150 cm	7 mm	39,99	35,99	31,99	63,99
KRAKEN SHAFT BOTTOM FLOP	FA406160	160 cm	7 mm	39,99	35,99	31,99	63,99
KRAKEN SHAFT BOTTOM FLOP	FA407090	90 cm	6 mm	34,38	30,94	27,50	54,99
KRAKEN SHAFT BOTTOM FLOP	FA407105	105 cm	6 mm	34,38	30,94	27,50	54,99
KRAKEN SHAFT BOTTOM FLOP	FA407120	120 cm	6 mm	34,38	30,94	27,50	54,99
KRAKEN SHAFT BOTTOM FLOP	FA407130	130 cm	6 mm	34,38	30,94	27,50	54,99
KRAKEN SHAFT BOTTOM FLOP	FA404902	90 cm	6.5 mm	34,99	31,49	27,99	55,99
KRAKEN SHAFT BOTTOM FLOP	FA404903	105 cm	6.5 mm	34,99	31,49	27,99	55,99
KRAKEN SHAFT BOTTOM FLOP	FA404904	120 cm	6.5 mm	34,99	31,49	27,99	55,99
KRAKEN SHAFT BOTTOM FLOP	FA404905	130 cm	6.5 mm	34,99	31,49	27,99	55,99
KRAKEN SHAFT BOTTOM FLOP	FA404906	140 cm	6.5 mm	34,99	31,49	27,99	55,99
KRAKEN SHAFT BOTTOM FLOP	FA404907	150 cm	6.5 mm	34,99	31,49	27,99	55,99

# BARRACUDA

## SLING GUN SHAFT: 17-4 PH NOTCHED TOP FLOP



PRODUCT	CODE	SIZE	Ø	DLR €	10%	SEASONAL ORDER 20%	RRP €
BARRACUDA SHAFT TOP FLOP	FA410002	90 cm	6 mm	23,13	20,82	18,50	36,99
BARRACUDA SHAFT TOP FLOP	FA410003	105 cm	6 mm	23,13	20,82	18,50	36,99
BARRACUDA SHAFT TOP FLOP	FA410004	115 cm	6 mm	23,13	20,82	18,50	36,99
BARRACUDA SHAFT TOP FLOP	FA410005	125 cm	6 mm	23,13	20,82	18,50	36,99
BARRACUDA SHAFT TOP FLOP	FA410006	130 cm	6 mm	23,13	20,82	18,50	36,99
BARRACUDA SHAFT TOP FLOP	FA410007	140 cm	6 mm	23,13	20,82	18,50	36,99
BARRACUDA SHAFT TOP FLOP	FA410008	150 cm	6 mm	23,13	20,82	18,50	36,99
BARRACUDA SHAFT TOP FLOP	FA410502	90 cm	6.5 mm	24,99	22,49	19,99	39,99
BARRACUDA SHAFT TOP FLOP	FA410503	105 cm	6.5 mm	24,99	22,49	19,99	39,99
BARRACUDA SHAFT TOP FLOP	FA410504	115 cm	6.5 mm	24,99	22,49	19,99	39,99
BARRACUDA SHAFT TOP FLOP	FA410505	125 cm	6.5 mm	24,99	22,49	19,99	39,99
BARRACUDA SHAFT TOP FLOP	FA410506	130 cm	6.5 mm	24,99	22,49	19,99	39,99
BARRACUDA SHAFT TOP FLOP	FA410507	140 cm	6.5 mm	24,99	22,49	19,99	39,99
BARRACUDA SHAFT TOP FLOP	FA410508	150 cm	6.5 mm	24,99	22,49	19,99	39,99



/ GUN SHAFTS

# VERDESCA

## SLING GUN SHAFT: PR80 NOTCHED TOP FLOP



CODE	SIZE	Ø	DLR €	10%	SEASONAL ORDER 20%	RRP €
FA340000	65 cm	6.5 mm	9.38	8.44	7.50	14.99
FA340001	75 cm	6.5 mm	9.38	8.44	7.50	14.99
FA340002	90 cm	6.5 mm	9.38	8.44	7.50	14.99
FA340003	105 cm	6.5 mm	9.38	8.44	7.50	14.99

## SLING GUN SHAFT: PR80 NOTCHED THREADED



CODE	SIZE	Ø	DLR €	10%	SEASONAL ORDER 20%	RRP €
FA350535	60 cm	7 mm	7.19	6.47	5.75	11.50
FA350545	70 cm	7 mm	7.19	6.47	5.75	11.50
FA350560	80 cm	7 mm	7.19	6.47	5.75	11.50
FA350575	95 cm	7 mm	7.19	6.47	5.75	11.50
FA350590	105 cm	7 mm	7.19	6.47	5.75	11.50

# LIBECCIO

## PNEUMATIC GUN SHAFT: PR80 THREADED

For Cressi pneumatic spearguns, threaded to fit any Cressi threaded spear tip.

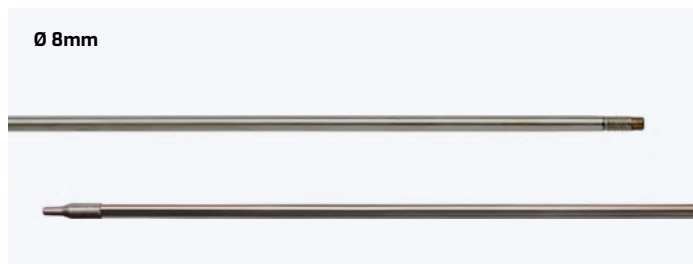

CODE	SIZE	DLR €	10%	SEASONAL ORDER 20%	RRP €
FA360036	36.5 cm	9.38	8.44	7.50	14.99
FA361036	55 cm	9.38	8.44	7.50	14.99
FA362036	68.5 cm	9.38	8.44	7.50	14.99
FA363036	87.5 cm	9.38	8.44	7.50	14.99
FA365036	99.5 cm	9.38	8.44	7.50	14.99
FA366036	109.5 cm	9.38	8.44	7.50	14.99

# SCIROCCO

## PNEUMATIC GUN SHAFT: INOX THREADED

Tempered steel shaft for Cressi pneumatic spearguns.

Threaded to fit any Cressi threaded spear tip.

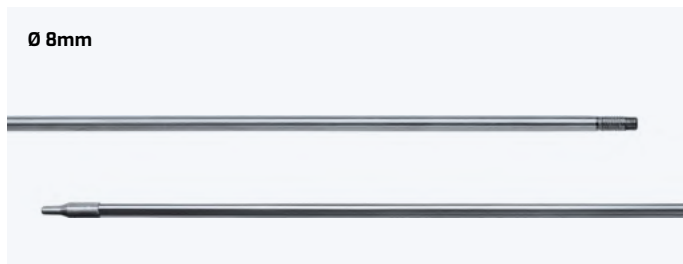

CODE	SIZE	DLR €	10%	SEASONAL ORDER 20%	RRP €
FA360030	36.5 cm	10.63	9.57	8.50	16.99
FA360031	55 cm	10.63	9.57	8.50	16.99
FA360032	68.5 cm	10.63	9.57	8.50	16.99
FA360033	87.5 cm	10.63	9.57	8.50	16.99
FA360034	99.5 cm	10.63	9.57	8.50	16.99
FA360035	109.5 cm	10.63	9.57	8.50	16.99

# SPEARHEAD



PRODUCT	CODE	DLR €	10%	SEASONAL ORDER 20%	RRP €
MINI SPEAR HEAD INOX	FA390001	7.49	6.74	5.99	11.99
MACH SPEAR HEAD	FA390004	4.99	4.49	3.99	7.99



# MULTIPRONGS

3 - 4 - 5  
POINTS

**WITH Ø MM 7.00 THREADS  
FIT ON Ø MM 7.00 & Ø MM 8.00 SHAFTS**

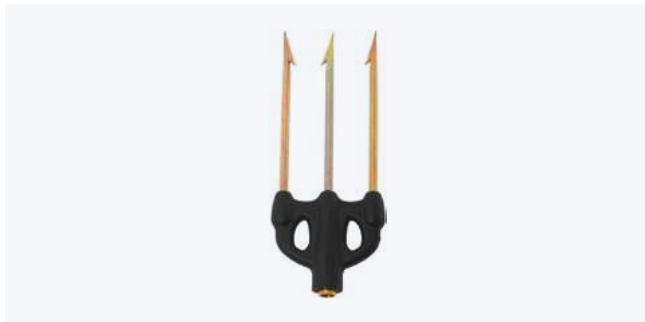

PRODUCT	CODE	DLR €	10%	SEASONAL ORDER 20%	RRP €
NYLON 3 POINTS TEMPERED	FA390008	5,63	5,07	4,50	8,99

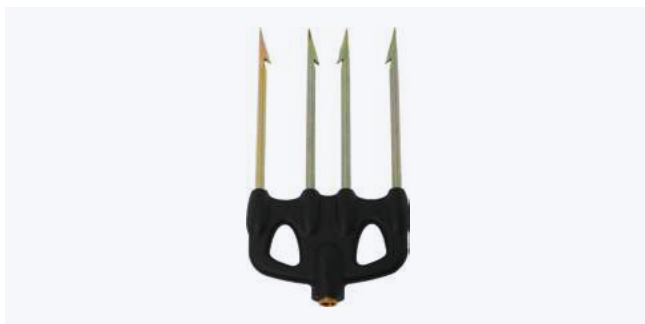

PRODUCT	CODE	DLR €	10%	SEASONAL ORDER 20%	RRP €
NYLON 4 POINTS TEMPERED	FA390011	6,56	5,9	5,25	10,50



PRODUCT	CODE	DLR €	10%	SEASONAL ORDER 20%	RRP €
NYLON 3 POINTS INOX	FA390015	6,56	5,9	5,25	10,50

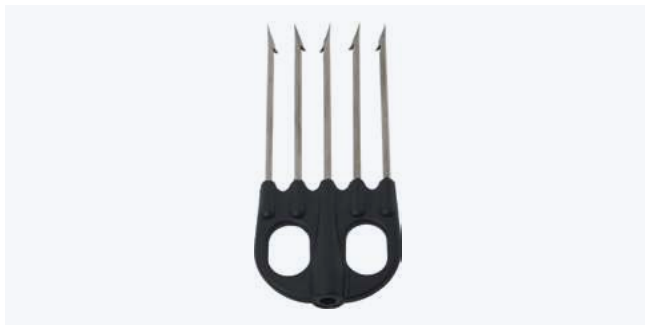

PRODUCT	CODE	DLR €	10%	SEASONAL ORDER 20%	RRP €
NYLON 5 POINTS INOX	FA390016	9,99	8,99	7,99	15,99

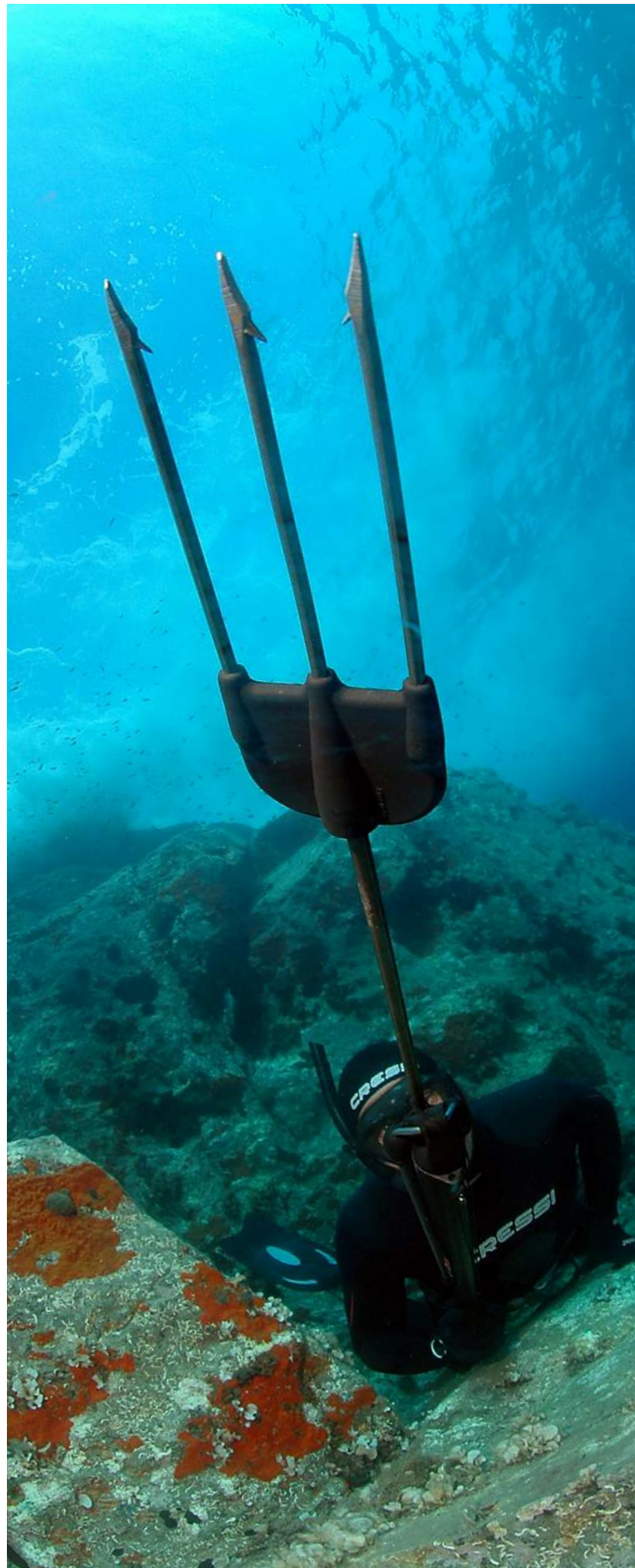

# REELS

## R20 - R30 - R50

The frame and the central pin are in AISI 316 steel. The drilling on the frame itself allows it to be used also on arbalete spearguns of different brands. The special clutch provides an excellent closing torque. The assembly system allows easy maintenance

and cleaning. All sizes are equipped with a rewinder ring and size R50 is also equipped with an anti-blocking roller. The models R30 and R50 are equipped with a lightened drum in order to weigh as little as possible on the balance of the speargun.



PRODUCT	CODE	DLR €	10%	SEASONAL ORDER 20%	RRP €
REEL R20	FA359020	31,24	28,12	24,99	49,99
REEL R30	FA359030	34,99	31,49	27,99	55,99
REEL R50	FA359050	43,74	39,37	34,99	69,99

### TECHNICAL FEATURES

- Reel of sturdy construction that combines the resistant Delrin material with assembly elements in AISI316 stainless steel
- Constructed from a single piece of Delrin which is worked by a high precision lathe
- Stainless steel mechanism
- Length for line: 50 m - 160 ft with line Ø 1.5 mm
- Dovetail mounting for quick assembly, compatible with many Cressi rifle models

# REELS

## FISHING REEL

New Reel for Cressi Spearguns. The Cressi Fishing Reel is a light and quick reel that will fit to the underside of your Cressi speargun with the dovetail mount. A tightening nut will hold the reel from paying out line and small handle help you reel your catch back in. Streamlined, low profile, horizontal line reel tecnopolimer reinforced construction

metal inserts for added durability and strength Adjustable drag knob attaches to standard rail mounts or provided adapter for all rubber spearguns Cressi. Adjustable drag knob allows for easy control of line release reate. Dovetail mounting system.



PRODUCT	CODE	DLR €	10%	SEASONAL ORDER 20%	RRP €
FISHING REEL	FA359001	18,13	16,32	14,50	29,99

### TECHNICAL FEATURES

- Durable-and-Effective
- Smooth Multi-Adjustable Clutch Style Drag System
- Clutch Style Drag System, Adjustable when Paying-Out Line
- Ergonomic Easily Accessible Star Adjusting Knob
- Vertical Mount Design for Minimal Drag
- Material: Non-Corrosive, Durable and Impact Resistant Plastic
- Dimension: 10.9 x 15 x 9.4 centimeters



## WISHBONE STANDARD



CODE	DLR €	10%	SEASONAL ORDER 20%	RRP €
FA350022	4,38	3,94	3,50	6,99

## JOINTED WISHBONE - A



CODE	DLR €	10%	SEASONAL ORDER 20%	RRP €
FA350020	13,74	12,37	10,99	21,99



## SHAFT REFLOATER



CODE	DLR €	10%	SEASONAL ORDER 20%	RRP €
FA354523	18,13	16,32	14,50	28,99

## SHAFT LOADER

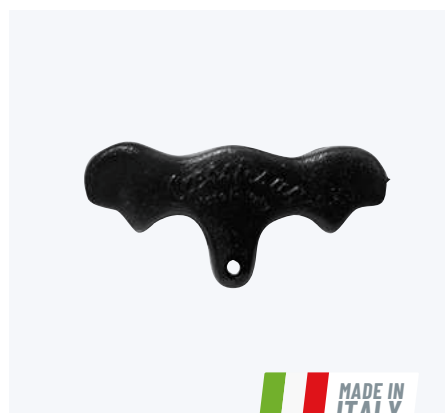

MADE IN ITALY

CODE	DLR €	10%	SEASONAL ORDER 20%	RRP €
FA390018	2,19	1,97	1,75	3,50

## SILICONE SPRAY 200 ml



CODE	DLR €	10%	SEASONAL ORDER 20%	RRP €
FA390025	9,38	8,44	7,50	14,99

## SPEARGUN OIL 100 ml



CODE	DLR €	10%	SEASONAL ORDER 20%	RRP €
FA390022	3,74	3,37	2,99	5,99

## GAUGE FOR GUNS



MADE IN ITALY

PRODUCT	CODE	DLR €	10%	SEASONAL ORDER 20%	RRP €
SL/SL STAR	FA390020	82,49	74,24	65,99	131,99
SAETTA	FA390032	82,49	74,24	65,99	131,99

## HAND PUMP



MADE IN ITALY

PRODUCT	CODE	DLR €	10%	SEASONAL ORDER 20%	RRP €
SL/SL STAR	FA320060	16,24	14,62	12,99	25,99
SAETTA	FZ370073	16,24	14,62	12,99	25,99



### MULTIFILAMENT Ø 1,4mm



**DIAMETER:** 1.4 mm  
**LENGTH:** 5 mt - 16.4 feet + 2 Sleeves

CODE	DLR €	10%	SEASONAL ORDER 20%	RRP €
FA354525	3,13	2,82	2,50	4,99

### MONOFILAMENT Ø 1,6mm



**DIAMETER:** 1.6 mm  
**LENGTH:** 5 mt - 16.4 feet + 2 Sleeves

CODE	DLR €	10%	SEASONAL ORDER 20%	RRP €
FA354522	3,13	2,82	2,50	4,99

### MONOFILAMENT Ø 1,8mm



**DIAMETER:** 1.8 mm  
**LENGTH:** 5 mt - 16.4 feet + 2 Sleeves

CODE	DLR €	10%	SEASONAL ORDER 20%	RRP €
FA354524	3,44	3,1	2,75	5,50

### LINE FOR REEL



**DIAMETER:** 2 mm  
**LENGTH:** 200 mt

CODE	DLR €	10%	SEASONAL ORDER 20%	RRP €
FA353035	39,38	35,44	31,50	62,99

### HIGH TENACITY LINE



**DIAMETER:** 2.5 mm  
**LENGTH:** 200 mt

CODE	DLR €	10%	SEASONAL ORDER 20%	RRP €
FA390030	48,13	43,32	38,50	76,99

### SHOCK ABSORBER



CODE	DLR €	10%	SEASONAL ORDER 20%	RRP €
FA354603	8,74	7,87	6,99	13,99

### COMPETITION FLOPPERS



CODE	DLR €	10%	SEASONAL ORDER 20%	RRP €
FA354520	3,13	2,82	2,50	4,99

### FISHING HOOK



CODE	DLR €	10%	SEASONAL ORDER 20%	RRP €
FA354521	10,63	9,57	8,50	16,99





CRESSI

SPEARFISHING  
WETSUITS



# RICCIOLA SPECIALIZED Retailer-Product

CHEST REINFORCEMENT  
SANDWICH NEOPRENE

HIGH WAISTED TROUSERS  
OPEN CELL NEOPRENE

16-24° C  
60.8-75.2° F  
CE CERTIFICATION DIVING WETSUIT EN 14225-1:2017. C

5 mm CE

10-18° C  
50-64.4° F  
CE CERTIFICATION DIVING WETSUIT EN 14225-1:2017. B

7 mm CE

## TWO-PIECE WETSUIT 5 mm, 7+5 mm

### SMOOTH MATERIAL WARMS UP QUICKLY

For effortless breathing and wearability, the most sensitive areas of this wetsuit use a new smooth, dual layer neoprene called "Sandwich Neoprene", which is highly flexible, has great thermal power and at the same time is very sturdy and durable. This neoprene has a 1 mm thick outer layer and a 4 mm (or 6 mm) dual inner layer separated by a

structural elastic lining. Thanks to this technology, it may be sewn to obtain strong seams and will not tear. The wetsuit benefits from an underarm panel that facilitates comfort and wearability. The design is rigorously anatomical. Protective reinforcement on sternum, knees and crotch. Watertight seals in smooth skin on hood, wrists and ankles.



**sandwich**

EXT: 1mm smooth skin  
INT: 4/6mm open cell neoprene  
Ultra elastic fabric

PRODUCT	CODE	DLR €	10%	SEASONAL ORDER 20%	RRP €
RICCIOLA MAN 2-PIECE WETSUIT 5mm S/2	LU490402	256,24	230,62	204,99	389,99
RICCIOLA MAN 2-PIECE WETSUIT 5mm M/3	LU490403	256,24	230,62	204,99	389,99
RICCIOLA MAN 2-PIECE WETSUIT 5mm L/4	LU490404	256,24	230,62	204,99	389,99
RICCIOLA MAN 2-PIECE WETSUIT 5mm XL/5	LU490405	256,24	230,62	204,99	389,99
RICCIOLA MAN 2-PIECE WETSUIT 5mm 2XL/6	LU490406	256,24	230,62	204,99	389,99
RICCIOLA MAN 2-PIECE WETSUIT 7+5mm S/2	LU490412	262,49	236,24	209,99	399,99
RICCIOLA MAN 2-PIECE WETSUIT 7+5mm M/3	LU490413	262,49	236,24	209,99	399,99
RICCIOLA MAN 2-PIECE WETSUIT 7+5mm L/4	LU490414	262,49	236,24	209,99	399,99
RICCIOLA MAN 2-PIECE WETSUIT 7+5mm XL/5	LU490415	262,49	236,24	209,99	399,99
RICCIOLA MAN 2-PIECE WETSUIT 7+5mm 2XL/6	LU490416	262,49	236,24	209,99	399,99

### TECHNICAL FEATURES



Smooth skin watertight seals



Protective reinforcement

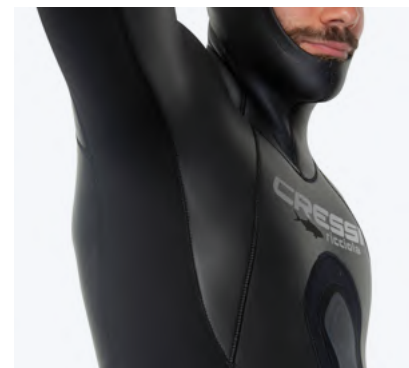

Single piece underarm section



Chest reinforcement Kneepad



# LAMPUGA SPECIALIZED

Retailer-Product

PADDED CHEST REINFORCEMENT

HIGH WAISTED TROUSERS

16-24° C  
60.8-75.2° F  
CE CERTIFICATION  
DIVING WETSUIT  
EN 14225-1:2017: C

5 mm  
CE

10-18° C  
50-64.4° F  
CE CERTIFICATION  
DIVING WETSUIT  
EN 14225-1:2017: B

7 mm  
CE

CRYPTIC CAMOUFLAGE TECHNOLOGY

## TWO-PIECE WETSUIT 5 mm, 7+5 mm

### INSPIRED BY THE LIVERY OF THE PELAGIC FISH

A special digital printing system has been used for this new camouflage wetsuit, allowing high-resolution images to be obtained and thus create an exclusive camouflage design. The new "Cryptic Camouflage Technology" of Cressi is based on a real image of a fish (a dolphin fish in this case, with

its dominant colours), to create camouflage that is very close to the original and then altered to obtain a repetitive effect that is one of a kind. The wetsuit is manufactured in two separate 5 or 7 mm pieces (jacket and pants). The materials used are: highly-elastic camo on the outside, open-cell neoprene on the inside.



### TECHNICAL FEATURES

- Preformed anatomical cut
- Jacket with padded reinforcement on the chest
- Watertight seals in smooth skin on hood, wrists and ankles
- Reinforced anti-abrasion lining on the chest and knees
- High-waisted trousers with watertight seals on the ankles and waist



Smooth skin watertight seals



Protective reinforcement Aqua stop system



Single piece underarm section



Chest reinforcement Kneepad



PRODUCT	CODE	DLR €	10%	SEASONAL ORDER 20%	RRP €
LAMPUGA MAN 2-PIECE WETSUIT CAMOU 5mm S/2	LU490102	212.49	191.24	169.99	319.99
LAMPUGA MAN 2-PIECE WETSUIT CAMOU 5mm M/3	LU490103	212.49	191.24	169.99	319.99
LAMPUGA MAN 2-PIECE WETSUIT CAMOU 5mm L/4	LU490104	212.49	191.24	169.99	319.99
LAMPUGA MAN 2-PIECE WETSUIT CAMOU 5mm XL/5	LU490105	212.49	191.24	169.99	319.99
LAMPUGA MAN 2-PIECE WETSUIT CAMOU 5mm 2XL/6	LU490106	212.49	191.24	169.99	319.99
LAMPUGA MAN 2-PIECE WETSUIT CAMOU 7+5mm S/2	LU490202	224.99	202.49	179.99	339.99
LAMPUGA MAN 2-PIECE WETSUIT CAMOU 7+5mm M/3	LU490203	224.99	202.49	179.99	339.99
LAMPUGA MAN 2-PIECE WETSUIT CAMOU 7+5mm L/4	LU490204	224.99	202.49	179.99	339.99
LAMPUGA MAN 2-PIECE WETSUIT CAMOU 7+5mm XL/5	LU490205	224.99	202.49	179.99	339.99
LAMPUGA MAN 2-PIECE WETSUIT CAMOU 7+5mm 2XL/6	LU490206	224.99	202.49	179.99	339.99



# SCORPIONFISH

## TWO-PIECE WETSUIT 5 mm

### INSPIRED BY THE FISH ON THE SEAFOUND

A special digital printing system has been used for this new camouflage wetsuit, allowing high-resolution images to be obtained and thus create an exclusive camouflage design. The new "Cryptic Camouflage Technology" of Cressi is based on a real image of a fish (a scorpion fish in this case,

with its dominant colours), to create camouflage that is very close to the original and then altered to obtain a repetitive effect that is one of a kind. The wetsuit is manufactured in two separate 5 mm pieces (jacket and leggings). The materials used are: highly-elastic camo on the outside, open-cell neoprene on the inside.



PADDED CHEST REINFORCEMENT

HIGH WAISTED TROUSERS

16-24° C  
60.8-75.2° F  
CE CERTIFICATION  
DIVING WETSUIT  
EN 14225-1:2017: C



CRYPTIC CAMOUFLAGE TECHNOLOGY

### TECHNICAL FEATURES

- Preformed anatomical cut
- Jacket with padded reinforcement on the chest
- Watertight seals in smooth skin on hood, wrists and ankles
- Reinforced anti-abrasion lining on the chest and knees
- High-waisted trousers with watertight seals on the ankles and waist



Smooth skin watertight seals



Protective reinforcement Aqua stop system



Single piece underarm section



Chest reinforcement Kneepad



PRODUCT	CODE	DLR €	10%	SEASONAL ORDER 20%	RRP €
SCORPIONFISH MAN 2-PIECE WETSUIT RED CAMOU 5mm S/2	LU490302	212.49	191.24	169.99	319.99
SCORPIONFISH MAN 2-PIECE WETSUIT RED CAMOU 5mm M/3	LU490303	212.49	191.24	169.99	319.99
SCORPIONFISH MAN 2-PIECE WETSUIT RED CAMOU 5mm L/4	LU490304	212.49	191.24	169.99	319.99
SCORPIONFISH MAN 2-PIECE WETSUIT RED CAMOU 5mm XL/5	LU490305	212.49	191.24	169.99	319.99
SCORPIONFISH MAN 2-PIECE WETSUIT RED CAMOU 5mm 2XL/6	LU490306	212.49	191.24	169.99	319.99



# SEPPIA



**SPECIALIZED**  
Retailer-Product

PADDED CHEST REINFORCEMENT

HIGH WAISTED TROUSERS

>22° C  
>71.6° F  
CE CERTIFICATION  
DIVING WETSUIT  
EN 14225-1:2017: D

**3.5 mm**  
CE

16-24° C  
60.8-75.2° F  
CE CERTIFICATION  
DIVING WETSUIT  
EN 14225-1:2017: C

**5 mm**  
CE

10-18° C  
50-64.4° F  
CE CERTIFICATION  
DIVING WETSUIT  
EN 14225-1:2017: B

**7 mm**  
CE

## TWO-PIECE WETSUIT 3.5 mm, 5 mm, 7 mm

### WHEN WET CHANGES COLOUR ACCENTUATING MIMETISM

Wetsuit created with the exclusive new Cressi green / brown camouflage, computer-designed to make it more difficult for prey to create solid images, thereby confusing the wearer with the

background. Preformed anatomical cut. Jacket with padded reinforcement on the chest. Smooth skin with watertight seals on hood, wrists and ankles. Reinforced anti-abrasion lining on the chest and knees. High-waisted trousers with watertight seals on the ankles and waist.



### TECHNICAL FEATURES



Smooth skin watertight seals



Protective reinforcement



Single piece underarm section



Chest reinforcement Kneepad

SIZE	JACKET 3.5MM	DLR €	10%	SEASONAL ORDER 20%	RRP €
S/2	LE468002	106.24	95.62	84.99	164.99
M/3	LE468003	106.24	95.62	84.99	164.99
L/4	LE468004	106.24	95.62	84.99	164.99
XL/5	LE468005	106.24	95.62	84.99	164.99
2XL/6	LE468006	106.24	95.62	84.99	164.99

SIZE	PANTS 3.5MM	DLR €	10%	SEASONAL ORDER 20%	RRP €
S/2	LE468102	81.24	73.12	64.99	124.99
M/3	LE468103	81.24	73.12	64.99	124.99
L/4	LE468104	81.24	73.12	64.99	124.99
XL/5	LE468105	81.24	73.12	64.99	124.99
2XL/6	LE468106	81.24	73.12	64.99	124.99

SIZE	JACKET 5MM	DLR €	10%	SEASONAL ORDER 20%	RRP €
S/2	LE468202	118.74	106.87	94.99	184.99
M/3	LE468203	118.74	106.87	94.99	184.99
L/4	LE468204	118.74	106.87	94.99	184.99
XL/5	LE468205	118.74	106.87	94.99	184.99
2XL/6	LE468206	118.74	106.87	94.99	184.99

SIZE	PANTS 5MM	DLR €	10%	SEASONAL ORDER 20%	RRP €
S/2	LE468302	93.74	84.37	74.99	144.99
M/3	LE468303	93.74	84.37	74.99	144.99
L/4	LE468304	93.74	84.37	74.99	144.99
XL/5	LE468305	93.74	84.37	74.99	144.99
2XL/6	LE468306	93.74	84.37	74.99	144.99

SIZE	JACKET 7MM	DLR €	10%	SEASONAL ORDER 20%	RRP €
S/2	LE468402	137.49	123.74	109.99	209.99
M/3	LE468403	137.49	123.74	109.99	209.99
L/4	LE468404	137.49	123.74	109.99	209.99
XL/5	LE468405	137.49	123.74	109.99	209.99
2XL/6	LE468406	137.49	123.74	109.99	209.99

SIZE	PANTS 7MM	DLR €	10%	SEASONAL ORDER 20%	RRP €
S/2	LE468502	112.49	101.24	89.99	174.99
M/3	LE468503	112.49	101.24	89.99	174.99
L/4	LE468504	112.49	101.24	89.99	174.99
XL/5	LE468505	112.49	101.24	89.99	174.99
2XL/6	LE468506	112.49	101.24	89.99	174.99

# TRACINA

## TWO-PIECE WETSUIT 3.5 mm, 5 mm, 7 mm

CHEST REINFORCEMENT

HIGH WAISTED TROUSERS

>22° C  
>71.6° F  
CE CERTIFICATION  
DIVING WETSUIT  
EN 14225-1:2017: D

3.5 mm  
CE

16-24° C  
60.8-75.2° F  
CE CERTIFICATION  
DIVING WETSUIT  
EN 14225-1:2017: C

5 mm  
CE

10-18° C  
50-64.4° F  
CE CERTIFICATION  
DIVING WETSUIT  
EN 14225-1:2017: B

7 mm  
CE

### DISAPPEARS INTO THE SEABED

Wetsuit created with the exclusive new Cressi camouflage Dark Digital Specter Pat, computer designed to make it more difficult for prey to create solid images, thereby confusing the wearer with the background. Preformed anatomical cut. Jacket with padded reinforcement in the chest,

Smoothskin watertight seals on the hood, wrists, and waist, and reinforced Powertex lining at the elbows and waist. High-waisted trousers with watertight Smoothskin seals at the ankles and waist, and Powertex reinforcements on the knees. Camouflage color: Dark-Specter.



### TECHNICAL FEATURES



Smooth skin watertight seals



Protective reinforcement Aqua stop system



Chest reinforcement Kneepad

SIZE	JACKET 3.5MM	DLR €	10%	SEASONAL ORDER 20%	RRP €
S/2	LE464802	98.74	88.87	78.99	154.99
M/3	LE464803	98.74	88.87	78.99	154.99
L/4	LE464804	98.74	88.87	78.99	154.99
XL/5	LE464805	98.74	88.87	78.99	154.99
2XL/6	LE464806	98.74	88.87	78.99	154.99

SIZE	PANTS 3.5MM	DLR €	10%	SEASONAL ORDER 20%	RRP €
S/2	LE464902	74.99	67.49	59.99	114.99
M/3	LE464903	74.99	67.49	59.99	114.99
L/4	LE464904	74.99	67.49	59.99	114.99
XL/5	LE464905	74.99	67.49	59.99	114.99
2XL/6	LE464906	74.99	67.49	59.99	114.99

SIZE	JACKET 5MM	DLR €	10%	SEASONAL ORDER 20%	RRP €
S/2	LE465002	102.49	92.24	81.99	164.99
M/3	LE465003	102.49	92.24	81.99	164.99
L/4	LE465004	102.49	92.24	81.99	164.99
XL/5	LE465005	102.49	92.24	81.99	164.99
2XL/6	LE465006	102.49	92.24	81.99	164.99

SIZE	PANTS 5MM	DLR €	10%	SEASONAL ORDER 20%	RRP €
S/2	LE465102	78.74	70.87	62.99	124.99
M/3	LE465103	78.74	70.87	62.99	124.99
L/4	LE465104	78.74	70.87	62.99	124.99
XL/5	LE465105	78.74	70.87	62.99	124.99
2XL/6	LE465106	78.74	70.87	62.99	124.99

SIZE	JACKET 7MM	DLR €	10%	SEASONAL ORDER 20%	RRP €
S/2	LE465202	128.74	115.87	102.99	199.99
M/3	LE465203	128.74	115.87	102.99	199.99
L/4	LE465204	128.74	115.87	102.99	199.99
XL/5	LE465205	128.74	115.87	102.99	199.99
2XL/6	LE465206	128.74	115.87	102.99	199.99

SIZE	PANTS 7MM	DLR €	10%	SEASONAL ORDER 20%	RRP €
S/2	LE465302	99.99	89.99	79.99	149.99
M/3	LE465303	99.99	89.99	79.99	149.99
L/4	LE465304	99.99	89.99	79.99	149.99
XL/5	LE465305	99.99	89.99	79.99	149.99
2XL/6	LE465306	99.99	89.99	79.99	149.99

# APNEA

## TWO-PIECE WETSUIT 3.5 mm, 5 mm, 7 mm

### PERFECT ALSO FOR FREEDIVING

A well-cut suit with particular attention to comfort around the areas where the body suffers most friction. Internal layer in metallic

black and a thickness of 3,5 mm, 5 mm and 7 mm. New design of the loading/reloading chestplate and special kneepads for extra protection.

CHEST REINFORCEMENT

HIGH WAISTED TROUSERS

🌡️ >22° C  
🌡️ >71.6° F  
CE CERTIFICATION DIVING WETSUIT EN 14225-1:2017: D

**3.5 mm**  
CE

🌡️ 16-24° C  
🌡️ 60.8-75.2° F  
CE CERTIFICATION DIVING WETSUIT EN 14225-1:2017: C

**5 mm**  
CE

🌡️ 10-18° C  
🌡️ 50-64.4° F  
CE CERTIFICATION DIVING WETSUIT EN 14225-1:2017: B

**7 mm**  
CE



### TECHNICAL FEATURES



Protective reinforcement



Chest reinforcement Kneepad



SIZE	3.5MM	DLR €	10%	SEASONAL ORDER 20%	RRP €
S/2	LE450102	149,99	134,99	119,99	229,99
M/3	LE450103	149,99	134,99	119,99	229,99
L/4	LE450104	149,99	134,99	119,99	229,99
XL/5	LE450105	149,99	134,99	119,99	229,99
2XL/6	LE450106	149,99	134,99	119,99	229,99

SIZE	5MM	DLR €	10%	SEASONAL ORDER 20%	RRP €
S/2	LE450202	156,24	140,62	124,99	249,99
M/3	LE450203	156,24	140,62	124,99	249,99
L/4	LE450204	156,24	140,62	124,99	249,99
XL/5	LE450205	156,24	140,62	124,99	249,99
2XL/6	LE450206	156,24	140,62	124,99	249,99

SIZE	7MM	DLR €	10%	SEASONAL ORDER 20%	RRP €
S/2	LE450302	187,49	168,74	149,99	299,99
M/3	LE450303	187,49	168,74	149,99	299,99
L/4	LE450304	187,49	168,74	149,99	299,99
XL/5	LE450305	187,49	168,74	149,99	299,99
2XL/6	LE450306	187,49	168,74	149,99	299,99



# TOKUGAWA

## MONOPIECE WETSUIT 3 mm

**DESIGNED FOR BLUE WATER SPEARFISHING**  
Tokugawa, named after the Japanese feudal shogunate, is a one-piece 3 mm thick wetsuit, perfect for spearfishing, freediving and swimming, as well as for open water and pool training. The unique camouflage of this wetsuit is appropriate for different aquatic environments, from the blue waters of the Caribbean Sea to the greener tones of North American waters. The wetsuit's graphics provide the ultimate in camouflage for

all environments. Tokugawa, which is made of elastic, flexible, comfortable and soft neoprene, has an anatomically designed cut specific to Cressi wetsuits, with preformed arms and legs that improve wearability and movement in the water. The chest and the knee pad reinforcements are designed specifically for spearfishing. The Dura Stretch nylon lining improves the wetsuit's elasticity, comfort and durability.

FOR SPEARFISHING, FREEDIVING & SWIMMING | CAMOUFLAGE DESIGN | REAR ZIPPER



### TECHNICAL FEATURES



Smooth skin watertight seals



Back zip



Chest reinforcement



Kneepad



PRODUCT	CODE	DLR €	10%	SEASONAL ORDER 20%	RRP €
TOKUGAWA MAN MONOPIECE WETSUIT BLUE CAMO 3mm S/2	LU490002	112,49	101,24	89,99	179,99
TOKUGAWA MAN MONOPIECE WETSUIT BLUE CAMO 3mm M/3	LU490003	112,49	101,24	89,99	179,99
TOKUGAWA MAN MONOPIECE WETSUIT BLUE CAMO 3mm L/4	LU490004	112,49	101,24	89,99	179,99
TOKUGAWA MAN MONOPIECE WETSUIT BLUE CAMO 3mm XL/5	LU490005	112,49	101,24	89,99	179,99
TOKUGAWA MAN MONOPIECE WETSUIT BLUE CAMO 3mm 2XL/6	LU490006	112,49	101,24	89,99	179,99

# SPEARFISHING VESTS





# COBIA NEW 2023

## LONG SLEEVES CAMOU RASHGUARD

The Cobia is the ultimate rash guard that features a chest area completely made in 1mm premium Neoprene to provide extra warmth. It's hooded for give the opportunity to protect and to heat also the

head. The Cobia can be worn under a wetsuit for give more warmth and protection. Can be used in any water sports, from windsurfing to scuba diving.



### TECHNICAL FEATURES

- The Cobia is the ultimate rash guard that features a chest area completely made in 1mm premium Neoprene to provide extra warmth.
- Hood for head protection.
- Wearable under or over a wetsuit for improve the warmth.
- Available in Cressi's mimetic pattern blue.
- Excellent anatomic cuts.

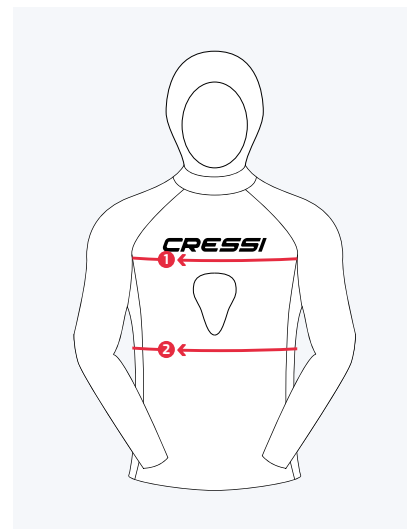

MAN	(H) HEIGHT	(1) CHEST	(2) WAIST
S	160/175 cm 5'3"/5'9"	75/85 cm 30/33 in	63/73 cm 24/29 in
M	165/180 cm 5'5"/5'11"	84/93 cm 33/37 in	69/79 cm 27/31 in
L	175-185 cm 5'9"/6'1"	90/100 cm 35/39 in	75/85 cm 30/33 in
XL	178-190 cm 5'10"/6'3"	98/109 cm 39/43 in	81/91 cm 32/36 in
2XL	185-195 cm 6'1"/6'5"	108/117 cm 43/46 in	89/97 cm 34/38 in
3XL	190-200 cm 6'3"/6'7"	115-125 cm 45/49 in	93-103 cm 37/41 in

PRODUCT	CODE	DLR €	10%	SEASONAL ORDER 20%	RRP €
COBIA BLUE HUNTER RASH GUARD S	USW011102B	62,49	56,24	49,99	99,99
COBIA BLUE HUNTER RASH GUARD M	USW011103B	62,49	56,24	49,99	99,99
COBIA BLUE HUNTER RASH GUARD L	USW011104B	62,49	56,24	49,99	99,99
COBIA BLUE HUNTER RASH GUARD XL	USW011105B	62,49	56,24	49,99	99,99
COBIA BLUE HUNTER RASH GUARD 2XL	USW011106B	62,49	56,24	49,99	99,99
COBIA BLUE HUNTER RASH GUARD 3XL	USW011107B	62,49	56,24	49,99	99,99





# SARAGO CAMO

SOFT HIGHLY ELASTIC NYLON-LINED NEOPRENE | ANTI-SLIP GRIP SOLE

## THERMAL NEOPRENE SOCKS 3 mm

These socks for fins with strap or foot pocket are made of soft highly elastic nylonlined NEW camouflage neoprene 3 mm. They prevent heat loss and keep feet warm. The smooth skin neoprene on the ankle allows maximum adherence between the sock and the leg of the wetsuit, reducing the passage of water. The sole is entirely non-slip. The construction of the blind stitch seam further improves comfort and aesthetics.



BROWN

BLUE



PRODUCT	THK	SIZE	BLUE	BROWN	DLR €	10%	SEASONAL ORDER 20%	RRP €
SARAGO SOCKS CAMOU	3 mm	S	XLX434322	XLX434312	23.74	21.37	18.99	37.99
SARAGO SOCKS CAMOU	3 mm	M	XLX434323	XLX434313	23.74	21.37	18.99	37.99
SARAGO SOCKS CAMOU	3 mm	L	XLX434324	XLX434314	23.74	21.37	18.99	37.99
SARAGO SOCKS CAMOU	3 mm	XL	XLX434325	XLX434315	23.74	21.37	18.99	37.99
SARAGO SOCKS CAMOU	3 mm	2XL	XLX434326	XLX434316	23.74	21.37	18.99	37.99

# TRACINA CAMO

## THERMAL NEOPRENE SOCKS 3 mm

Socks in Ultraspan, 3 mm elastic and hydrodynamic lining. Microporous inner lining with Blacklite® coating for greater thermal protection and waterproofing without the need to use soapy water to wear them. Nylon inner sole to prevent the foot from slipping inside when walking. Model designed according to the position of the foot during movement to avoid creases and tensions in the area of the instep.



ANTI-SLIP GRIP SOLE

PRODUCT	THK	SIZE	BROWN	DLR €	10%	SEASONAL ORDER 20%	RRP €
TRACINA SOCKS CAMOU	3 mm	S	LX433201	27.49	24.74	21.99	44.99
TRACINA SOCKS CAMOU	3 mm	M	LX433202	27.49	24.74	21.99	44.99
TRACINA SOCKS CAMOU	3 mm	L	LX433203	27.49	24.74	21.99	44.99
TRACINA SOCKS CAMOU	3 mm	XL	LX433204	27.49	24.74	21.99	44.99

# HEX NEW 2023

## CUT RESISTANT GLOVES

Cressi designed a glove that provides high comfort and dexterity while being cut puncture and impact-resistant, making it ideal for lobstering and spearfishing. The wrist velcro closer will always keep the glove in place, regardless of normal use expansion from water weight. Cressi's Dyfiber material offers maximum strength with minimum weight. It features the ANSI level 4 for cut resistance and level 3 for puncture resistance.

### TECHNICAL FEATURES

- ANSI Cut resistance level 4. Puncture resistance level 3.
- The back, knuckles and fingers have special protection against bumps and scratches.
- Palm in Sandy Nitrile coating increasing grip in wet and oily conditions.

CUT RESISTANCE LVL 4 | PUNCTURE RESISTANCE LVL 3 | BACK AND FINGERS SPECIAL PROTECTION | OPTIMAL GRIP IN ALL CONDITIONS



BLUE

LIME



PRODUCT	THK	SIZE	BLUE	LIME	DLR €	10%	SEASONAL ORDER 20%	RRP €
HEX GRIP GLOVES	3 mm	XS	PQ100601	PQ100607	31,24	28,12	24,99	49,99
HEX GRIP GLOVES	3 mm	S	PQ100602	PQ100608	31,24	28,12	24,99	49,99
HEX GRIP GLOVES	3 mm	M	PQ100603	PQ100609	31,24	28,12	24,99	49,99
HEX GRIP GLOVES	3 mm	L	PQ100604	PQ100610	31,24	28,12	24,99	49,99
HEX GRIP GLOVES	3 mm	XL	PQ100605	PQ100611	31,24	28,12	24,99	49,99
HEX GRIP GLOVES	3 mm	2XL	PQ100606	PQ100612	31,24	28,12	24,99	49,99

# TRACINA CAMO

## THERMAL NEOPRENE GLOVES 3 mm

3 mm camouflage version with 100% ULTRASpan outer coating. It offers great elasticity, comfort, hydrodynamics and quick drying. Microporous interior with Blacklite® coating for greater thermal protection and watertightness without the need to use soapy water to wear them. Fully lined with latex picot for better grip and durability. Preformed 3D model.



PRODUCT	CODE	DLR €	10%	SEASONAL ORDER 20%	RRP €
TRACINA GLOVES CAMOU 3mm S	LX477501	34,99	31,49	27,99	55,99
TRACINA GLOVES CAMOU 3mm M	LX477502	34,99	31,49	27,99	55,99
TRACINA GLOVES CAMOU 3mm L	LX477503	34,99	31,49	27,99	55,99
TRACINA GLOVES CAMOU 3mm XL	LX477504	34,99	31,49	27,99	55,99

# BACKWEIGHT

## ONE SIZE 3 mm

UP TO 6 KGS

Ballast holder backplate with quick release buckles and 6 handy pockets for traditional ballast or spherical lead weights. The high density neoprene eliminates trim variations and ensures better weight retention. Automatic release of the vest when one of the buckles is released.



PRODUCT	CODE	DLR €	10%	SEASONAL ORDER 20%	RRP €
BACKWEIGHT BLACK	LE500000	37,49	33,74	29,99	59,99

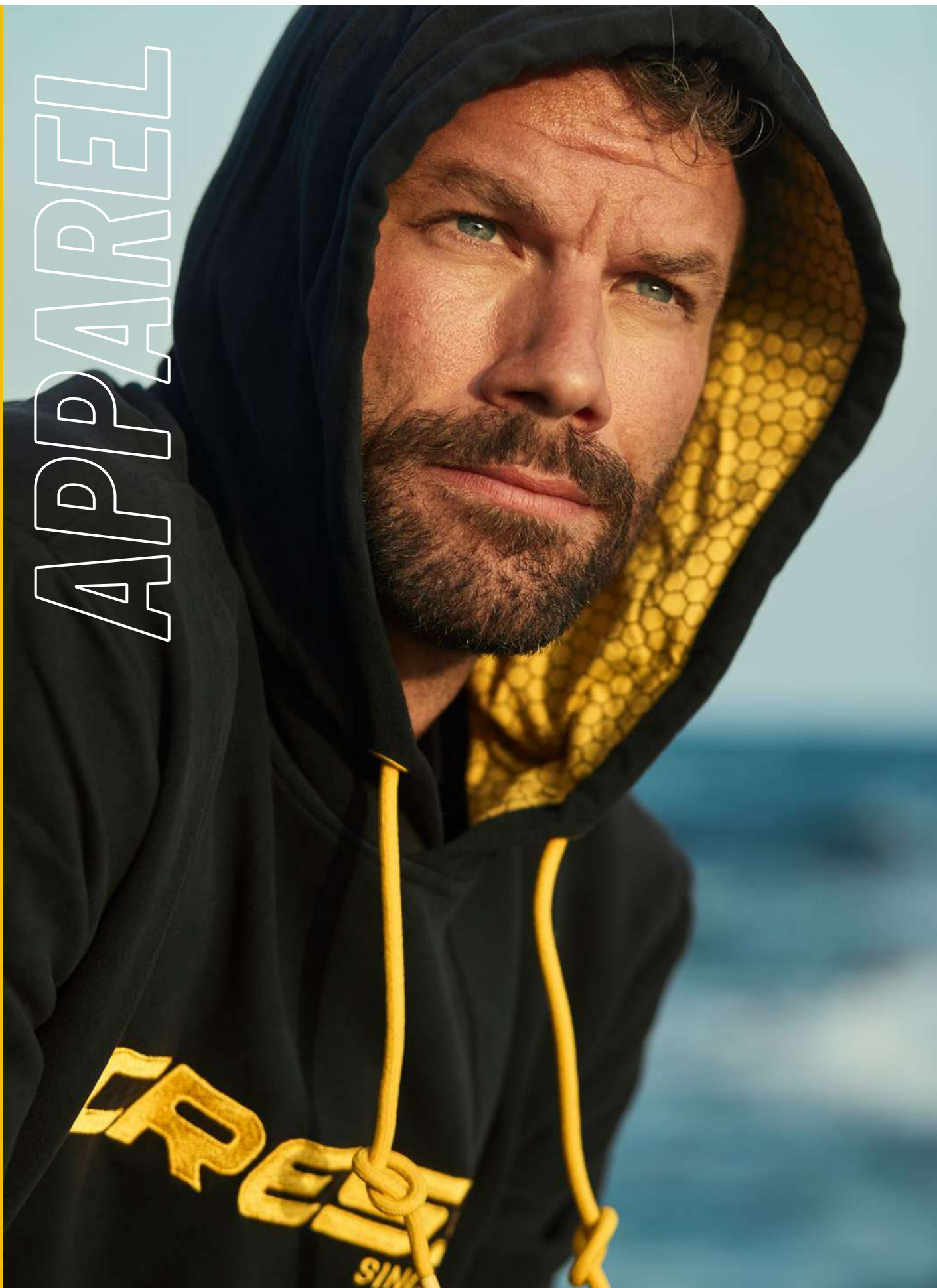

# APPAREL



# T-SHIRT

## MAN & LADY

Premium quality 100% cotton t-shirt, available in two colors and different fit for man and woman. Front and back printed logos.

Smooth collar and sleeve hem for maximum comfort.



<b>Fabric</b>	30/1 Jersey 100% Cotton, 150 gr
<b>Color</b>	Yellow / Black
<b>Print</b>	Front + Back + Inside neck



YELLOW



BLACK



MAN	(1) CHEST	(2) LENGTH
XS	48 cm (18.8 inch)	65 cm (25.6 inch)
S	50 cm (19.6 inch)	67 cm (26.4 inch)
M	52 cm (20.4 inch)	69 cm (27.1 inch)
L	54 cm (21.2 inch)	71 cm (28 inch)
XL	56 cm (22 inch)	73 cm (28.7 inch)
2XL	58 cm (22.8 inch)	75 cm (29.5 inch)
3XL	60 cm (23.6 inch)	77 cm (30.3 inch)

LADY	(1) CHEST	(2) LENGTH
XS	40 cm (15.7 inch)	60 cm (23.6 inch)
S	42 cm (16.5 inch)	62 cm (24.4 inch)
M	44 cm (17.3 inch)	62 cm (24.4 inch)
L	46 cm (18.1 inch)	64 cm (25.2 inch)
XL	48 cm (18.9 inch)	64 cm (25.2 inch)

PRODUCT	CODE	DLR €	10%	SEASONAL ORDER 20%	RRP €
CRESSI T-SHIRT MAN YELLOW/BLACK S	VA944112	24.38	21.94	19.50	38.99
CRESSI T-SHIRT MAN YELLOW/BLACK M	VA944113	24.38	21.94	19.50	38.99
CRESSI T-SHIRT MAN YELLOW/BLACK L	VA944114	24.38	21.94	19.50	38.99
CRESSI T-SHIRT MAN YELLOW/BLACK XL	VA944115	24.38	21.94	19.50	38.99
CRESSI T-SHIRT MAN YELLOW/BLACK 2XL	VA944116	24.38	21.94	19.50	38.99
CRESSI T-SHIRT LADY YELLOW/BLACK XS	VA944211	24.38	21.94	19.50	38.99
CRESSI T-SHIRT LADY YELLOW/BLACK S	VA944212	24.38	21.94	19.50	38.99
CRESSI T-SHIRT LADY YELLOW/BLACK M	VA944213	24.38	21.94	19.50	38.99
CRESSI T-SHIRT LADY YELLOW/BLACK L	VA944214	24.38	21.94	19.50	38.99
CRESSI T-SHIRT LADY YELLOW/BLACK XL	VA944215	24.38	21.94	19.50	38.99

PRODUCT	CODE	DLR €	10%	SEASONAL ORDER 20%	RRP €
CRESSI T-SHIRT MAN BLACK/YELLOW S	VA944152	24.38	21.94	19.50	38.99
CRESSI T-SHIRT MAN BLACK/YELLOW M	VA944153	24.38	21.94	19.50	38.99
CRESSI T-SHIRT MAN BLACK/YELLOW L	VA944154	24.38	21.94	19.50	38.99
CRESSI T-SHIRT MAN BLACK/YELLOW XL	VA944155	24.38	21.94	19.50	38.99
CRESSI T-SHIRT MAN BLACK/YELLOW 2XL	VA944156	24.38	21.94	19.50	38.99
CRESSI T-SHIRT LADY BLACK/YELLOW XS	VA944251	24.38	21.94	19.50	38.99
CRESSI T-SHIRT LADY BLACK/YELLOW S	VA944252	24.38	21.94	19.50	38.99
CRESSI T-SHIRT LADY BLACK/YELLOW M	VA944253	24.38	21.94	19.50	38.99
CRESSI T-SHIRT LADY BLACK/YELLOW L	VA944254	24.38	21.94	19.50	38.99
CRESSI T-SHIRT LADY BLACK/YELLOW XL	VA944255	24.38	21.94	19.50	38.99



# POLO

## SHORT SLEEVES - MAN & LADY

This slim-fit golf polo shirt is crafted from 100% 200 gr Cotton, and features three button placket and open-bottom hem. Classic mini stripe yarn dye design. Contrast colour

to underside of collar and sleeves. Embroidered Cressi front logo.

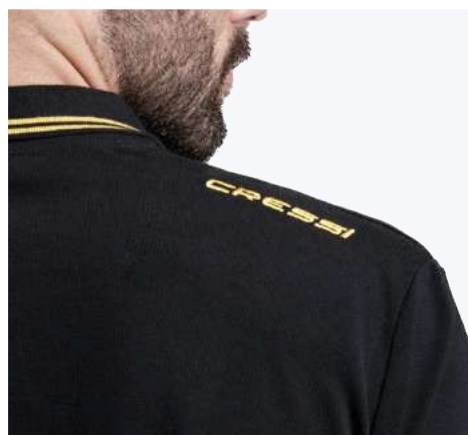

<b>Fabric</b>	30/1 Piquet 100% Cotton, 200 gr
<b>Color</b>	Black

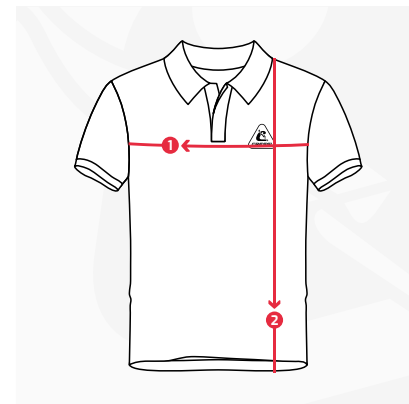

MAN	(1) CHEST	(2) LENGTH
XS	48 cm (18.8 inch)	67 cm (26.4 inch)
S	50 cm (19.6 inch)	69 cm (27.1 inch)
M	52 cm (20.4 inch)	71 cm (28 inch)
L	54 cm (21.2 inch)	73 cm (28.7 inch)
XL	56 cm (22 inch)	75 cm (29.5 inch)
2XL	58 cm (22.8 inch)	77 cm (30.3 inch)
3XL	60 cm (23.6 inch)	79 cm (31.1 inch)

LADY	(1) CHEST	(2) LENGTH
XS	40 cm (15.7 inch)	60 cm (23.6 inch)
S	42 cm (16.5 inch)	62 cm (24.4 inch)
M	44 cm (17.3 inch)	62 cm (24.4 inch)
L	46 cm (18.1 inch)	64 cm (25.2 inch)
XL	48 cm (18.9 inch)	64 cm (25.2 inch)

PRODUCT	CODE	DLR €	10%	SEASONAL ORDER 20%	RRP €
CRESSI POLO MAN BLACK/YELLOW S	VA944552	38,74	34,87	30,99	61,99
CRESSI POLO MAN BLACK/YELLOW M	VA944553	38,74	34,87	30,99	61,99
CRESSI POLO MAN BLACK/YELLOW L	VA944554	38,74	34,87	30,99	61,99
CRESSI POLO MAN BLACK/YELLOW XL	VA944555	38,74	34,87	30,99	61,99
CRESSI POLO MAN BLACK/YELLOW 2XL	VA944556	38,74	34,87	30,99	61,99
CRESSI POLO LADY BLACK/YELLOW XS	VA944651	38,74	34,87	30,99	61,99
CRESSI POLO LADY BLACK/YELLOW S	VA944652	38,74	34,87	30,99	61,99
CRESSI POLO LADY BLACK/YELLOW M	VA944653	38,74	34,87	30,99	61,99
CRESSI POLO LADY BLACK/YELLOW L	VA944654	38,74	34,87	30,99	61,99
CRESSI POLO LADY BLACK/YELLOW XL	VA944655	38,74	34,87	30,99	61,99



# HOODIE

## UNISEX

Made of a 95% Cotton and 5% Elastan blend, it features an attached hood with draw-cord closure, front hand-warmer pocket, reinforced rib-knit cuffs and waistband.

The Cressi front logo is embroidered. Inner hood enriched with a geometric texture.



<b>Fabric</b>	Fleece. 95% Cotton, 5% Elastan.
<b>Color</b>	Black
<b>Print</b>	Front + Back + Inside Hood



SIZE	(1) CHEST	(2) LENGTH
XS	50 cm (19.6 inch)	67 cm (26.4 inch)
S	52 cm (20.4 inch)	69 cm (27.1 inch)
M	54 cm (21.2 inch)	71 cm (28 inch)
L	56 cm (22 inch)	73 cm (28.7 inch)
XL	58 cm (22.8 inch)	75 cm (29.5 inch)
2XL	60 cm (23.6 inch)	77 cm (30.3 inch)
3XL	62 cm (24.4 inch)	79 cm (31.1 inch)

PRODUCT	CODE	DLR €	10%	SEASONAL ORDER 20%	RRP €
CRESSI HOODIE UNISEX BLACK/YELLOW XS	VA945601	60.63	54.57	48,50	96,99
CRESSI HOODIE UNISEX BLACK/YELLOW S	VA945602	60.63	54.57	48,50	96,99
CRESSI HOODIE UNISEX BLACK/YELLOW M	VA945603	60.63	54.57	48,50	96,99
CRESSI HOODIE UNISEX BLACK/YELLOW L	VA945604	60.63	54.57	48,50	96,99
CRESSI HOODIE UNISEX BLACK/YELLOW XL	VA945605	60.63	54.57	48,50	96,99
CRESSI HOODIE UNISEX BLACK/YELLOW 2XL	VA945606	60.63	54.57	48,50	96,99





# SWEATPANTS & BERMUDA

## UNISEX

**Fabric** Fleece. 95% Cotton, 5% Elastan.  
**Color** Black



SIZE	CODE	DLR €	10%	SEASONAL ORDER 20%	RRP €
XS	VA945701	48.13	43.32	38.50	76.99
S	VA945702	48.13	43.32	38.50	76.99
M	VA945703	48.13	43.32	38.50	76.99
L	VA945704	48.13	43.32	38.50	76.99
XL	VA945705	48.13	43.32	38.50	76.99
2XL	VA945706	48.13	43.32	38.50	76.99



**Fabric** Fleece. 95% Cotton, 5% Elastan.  
**Color** Black



SIZE	CODE	DLR €	10%	SEASONAL ORDER 20%	RRP €
XS	VA945801	42.49	38.24	33.99	67.99
S	VA945802	42.49	38.24	33.99	67.99
M	VA945803	42.49	38.24	33.99	67.99
L	VA945804	42.49	38.24	33.99	67.99
XL	VA945805	42.49	38.24	33.99	67.99
2XL	VA945806	42.49	38.24	33.99	67.99

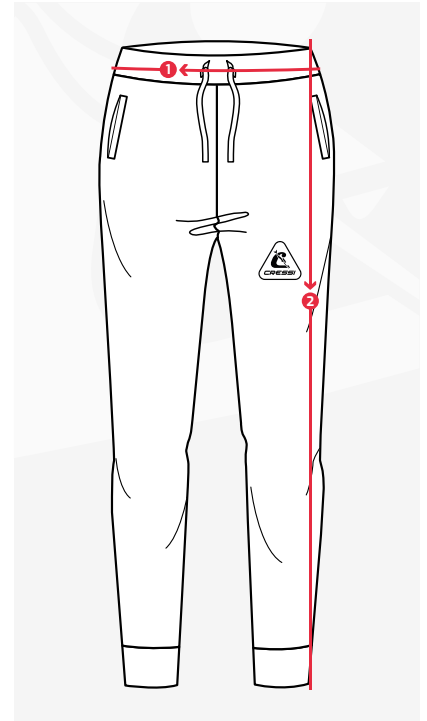

SIZE	(1) WAIST	(2) LENGTH
XS	36 cm (14.2 inch)	102 cm (40.1 inch)
S	38 cm (15 inch)	103 cm (40.5 inch)
M	40 cm (15.7 inch)	104 cm (40.9 inch)
L	42 cm (16.5 inch)	105 cm (41.3 inch)
XL	44 cm (17.3 inch)	106 cm (41.7 inch)
2XL	46 cm (18.1 inch)	107 cm (42.1 inch)
3XL	48 cm (18.9 inch)	108 cm (42.5 inch)

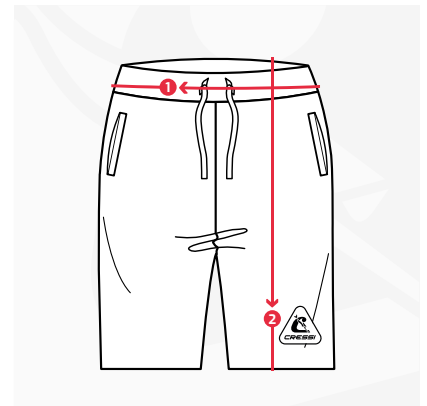

SIZE	(1) WAIST	(2) LENGTH
XS	36 cm (14.2 inch)	49 cm (19.2 inch)
S	38 cm (15 inch)	50 cm (19.6 inch)
M	40 cm (15.7 inch)	51 cm (20 inch)
L	42 cm (16.5 inch)	52 cm (20.4 inch)
XL	44 cm (17.3 inch)	53 cm (20.8 inch)
2XL	46 cm (18.1 inch)	54 cm (21.2 inch)
3XL	48 cm (18.9 inch)	55 cm (21.6 inch)

# SOFTSHELL JACKET

## UNISEX

100% polyester. Ultralight softshell jacket.  
Functional fabric with TPU membrane windproof and waterproof

Breathable and vapour-permeable

Sealed seams

Waterproof zipper

Two zippered side pockets.

Adjustable hood.

Slightly longer back.



SIZE	CODE	DLR €	10%	SEASONAL ORDER 20%	RRP €
UNISEX XS	VA945901	186.88	168.19	149.50	299.99
UNISEX S	VA945902	186.88	168.19	149.50	299.99
UNISEX M	VA945903	186.88	168.19	149.50	299.99
UNISEX L	VA945904	186.88	168.19	149.50	299.99
UNISEX XL	VA945905	186.88	168.19	149.50	299.99
UNISEX 2XL	VA945906	186.88	168.19	149.50	299.99

# CAP

## WITH ADJUSTABLE CLOSURE

**Fabric** 100% Brushed Cotton Twill. 260 gr

**Color** Black



PRODUCT	CODE	DLR €	10%	SEASONAL ORDER 20%	RRP €
CRESSI BASEBALL CAP BLACK/YELLOW	VA900150	16.88	15.19	13.50	26.99

# BEANIE

**Fabric** Outer 100% Polyacrylic

**Lining** 100% Polyester (Fleece). 3MTM Thinsulate™ Insulation

**Color** Black



PRODUCT	CODE	DLR €	10%	SEASONAL ORDER 20%	RRP €
CRESSI BEANIE BLACK/YELLOW	VA900250	11.88	10.69	9.50	18.99





# BRAND SUPPORT



# TOWER DISPLAY

## MOBILE METAL STAND DISPLAY

60x60x194 cm  
23.6x23.6x76 inch



PRODUCT	CODE	DLR €	10%	SEASONAL ORDER 20%	RRP €
TOWER DISPLAY BLACK/YELLOW	VAEMOMS	143.74	129.37	114.99	-

# HOOK FOR FINS

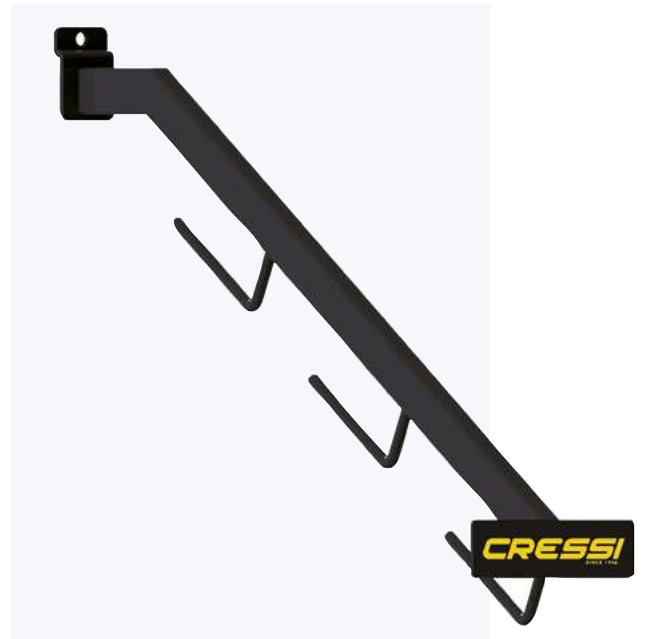

PRODUCT	CODE	DLR €	10%	SEASONAL ORDER 20%	RRP €
HOOK-W UNIT FOR FINS	VAEFINS	8.74	7.87	6.99	-

# HOOK FOR WETSUIT



PRODUCT	CODE	DLR €	10%	SEASONAL ORDER 20%	RRP €
HOOK-H UNIT FOR WETSUIT	VAEWETSUIT	8.74	7.87	6.99	-

# DIVE WATCH & COMPUTER DISPLAY

## METAL WALL DISPLAY



PRODUCT	CODE	DLR €	10%	SEASONAL ORDER 20%	RRP €
METAL WALL COMPUTER DISPLAY BLACK/YELLOW	VAEUMWC	13.13	11,82	10,50	-

# REGULATOR DISPLAY

## METAL WALL DISPLAY



PRODUCT	CODE	DLR €	10%	SEASONAL ORDER 20%	RRP €
METAL WALL REGULATOR DISPLAY BLACK/YELLOW	VAEUMWR	23.74	21,37	18,99	-

# DIVE WATCH & COMPUTER DISPLAY

## ACRYLIC TABLE DISPLAY



PRODUCT	CODE	DLR €	10%	SEASONAL ORDER 20%	RRP €
ACRYLIC TABLE TOP COMPUTER DISPLAY BLACK/YELLOW	VAEUATT	18,13	16,32	14,50	-

# MASK AND SNORKEL DISPLAY

## ACRYLIC TABLE DISPLAY



PRODUCT	CODE	DLR €	10%	SEASONAL ORDER 20%	RRP €
ACRYLIC TABLE TOP MASK+SNORKEL DISPLAY BLACK/YELLOW	VAEUAMS	18,13	16,32	14,50	-



# MASK DISPLAY

## ACRYLIC WALL DISPLAY



PRODUCT	CODE	DLR €	10%	SEASONAL ORDER 20%	RRP €
WALL MASK DISPLAY BLACK/YELLOW	VAEMASK	6,24	5,62	4,99	-

# SNORKEL DISPLAY

## ACRYLIC WALL DISPLAY



PRODUCT	CODE	DLR €	10%	SEASONAL ORDER 20%	RRP €
WALL SNORKEL DISPLAY BLACK/YELLOW	VAESNOR	4,99	4,49	3,99	-

# HOOK FOR GOGGLES

## ACRYLIC WALL DISPLAY



PRODUCT	CODE	DLR €	10%	SEASONAL ORDER 20%	RRP €
HOOK FOR GOGGLES BLACK/YELLOW	VAEWAGF	8,74	7,87	6,99	-

# FLAT DISPLAY

## ACRYLIC WALL DISPLAY



PRODUCT	CODE	DLR €	10%	SEASONAL ORDER 20%	RRP €
WALL FLAT DISPLAY BLACK/YELLOW	VAEFLAT	4,99	4,49	3,99	-

# DISPLAY

## SWIM AND SNORKELING PRODUCTS

Includes 50x Hooks to display the products

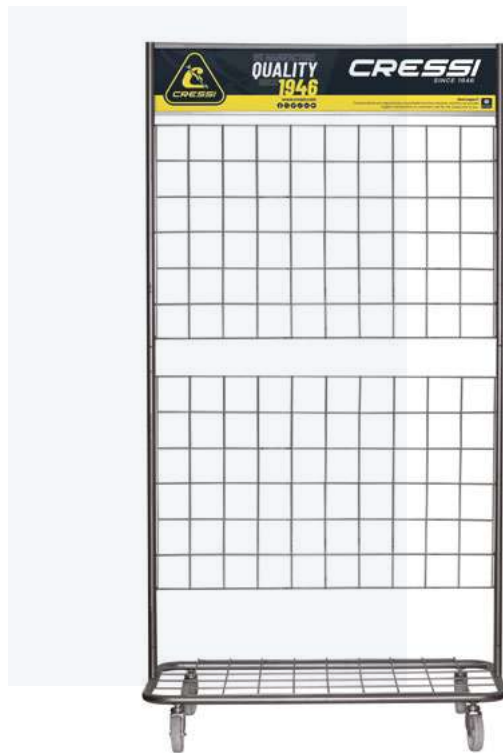

PRODUCT	CODE	DLR €	10%	SEASONAL ORDER 20%	RRP €
DISPLAY	VAESEA	119.99	107.99	95.99	-

# QUANTUM MASK

## POSTER AND DISPLAY



PRODUCT	CODE	DLR €	10%	SEASONAL ORDER 20%	RRP €
QUANTUM POSTER 70 X 100 cm	VPOSTERTM	7.49	6.74	5.99	-
QUANTUM A3 DISPLAY	CARTVETQM	7.49	6.74	5.99	-

# ATELIER SHOWCASE

## ATELIER SHOWCASE SIGN



PRODUCT	CODE	DLR €	10%	SEASONAL ORDER 20%	RRP €
SHOWCASE SIGN MICHELANGELO	CVATE01	6.24	5.62	4.99	-
SHOWCASE SIGN TECH RANGE	CVATE02	6.24	5.62	4.99	-
SHOWCASE SIGN NEOPRENE	CVATE03	6.24	5.62	4.99	-
SHOWCASE SIGN MASKS AND SNORKELS	CVATE04	6.24	5.62	4.99	-

# PRODUCTS ADV

## A3 DISPLAY



PRODUCT	CODE	DLR €	10%	SEASONAL ORDER 20%	RRP €
DIGI2 + DIGI ADV A3 DISPLAY	CARTVETDG01	7.49	6.74	5.99	-
KING ADV A3 DISPLAY	CARTVETKNG	7.49	6.74	5.99	-
MC9+COMPACT ADV A3 DISPLAY	CARTVETMC9C	7.49	6.74	5.99	-
QUANTUM ADV A3 DISPLAY	CARTVETQAD	7.49	6.74	5.99	-

# BANNERS AND FLAGS

## CRESSI SINCE 1946

Cressi banners and flags are the ideal support for retailers and events. Three different dimensions and shapes for every need. The choice of the new colours reinforces our corporate image.



**BANNER FLAG**  
350 X 60 CM



**RECTANGLE FLAG**  
150 X 90 CM



**WING FLAG**  
60 X 240 CM

POLE LENGTH: 340 CM



PRODUCT	CODE	DLR €	10%	SEASONAL ORDER 20%	RRP €
WING FLAG CRESSI BLACK/YELLOW 60x240cm	VABANCRO3	14,99	13,49	11,99	-
BANNER FLAG CRESSI BLACK/YELLOW 350x60 cm	VABANCRO2	12,49	11,24	9,99	-
RECTANGLE FLAG CRESSI BLACK/YELLOW 150x90 cm	VABANCRO1	8,74	7,87	6,99	-



# STICKERS

CRESSI SINCE 1946



**STICKER**  
Back adhesive side

<b>Small</b>	10 x 9,1 cm 3,94 x 3,58 inch
<b>Basic</b>	30 x 27 cm 11,8 x 10,6 inch
<b>XL Size</b>	58,5 x 53 cm 23 x 20,8 inch

PRODUCT	CODE	DLR €	10%	SEASONAL ORDER 20%	RRP €
CRESSI TRIANGLE STICKER BLACK/YELLOW 10x9,1 cm	VPADE5210	7,49	6,74	5,99	-
CRESSI TRIANGLE STICKER BLACK/YELLOW 30x27 cm	VPADE5010	7,49	6,74	5,99	-
CRESSI TRIANGLE STICKER BLACK/YELLOW 58,5x53 cm	VPADE5110	7,49	6,74	5,99	-



**STICKER**  
Back adhesive side

<b>Small</b>	15 x 15,3 cm 5,9 x 6 inch
<b>Basic</b>	30 x 30,5 cm 11,8 x 12 inch

PRODUCT	CODE	DLR €	10%	SEASONAL ORDER 20%	RRP €
CRESSI TRIANGLE AUT. DEAL STICKER BLACK/YELLOW 15X15,3 cm	VPADE5211	7,49	6,74	5,99	-
CRESSI TRIANGLE AUT. DEAL. STICKER BLACK/YELLOW 30x30,5 cm	VPADE5011	7,49	6,74	5,99	-



**STICKER**  
Back adhesive side

<b>Size</b>	48 x 21,1 cm 18,9 x 8,3 inch
-------------	---------------------------------

PRODUCT	CODE	DLR €	10%	SEASONAL ORDER 20%	RRP €
CRESSI RECTANGLE AUT. DEAL. STICKER BLACK/YELLOW 48x21,1 cm	VPADE5012	7,49	6,74	5,99	-

# DISPLAY

## CRESSI SINCE 1946

Cressi Since 1946 interior Display Totem is perfect to be exhibited in a shop or during an event.

### TECHNICAL FEATURES

<b>Base</b>	Triangular
<b>Dimensions</b>	156 x 60 x 60 x 53cm 61.5 x 23.5 x 23.5 x 21 inch



PRODUCT	CODE	DLR €	10%	SEASONAL ORDER 20%	RRP €
CRESSI 1946 DISPLAY TOTEM	TOTEMCR01	53.74	48.37	42.99	-

# DISPLAY

## SPEARFISHING

Cressi Spearfishing interior Display Totem is perfect to be exhibited in a shop or during an event.

### TECHNICAL FEATURES

<b>Base</b>	Triangular
<b>Dimensions</b>	156 x 60 x 60 x 53cm 61.5 x 23.5 x 23.5 x 21 inch

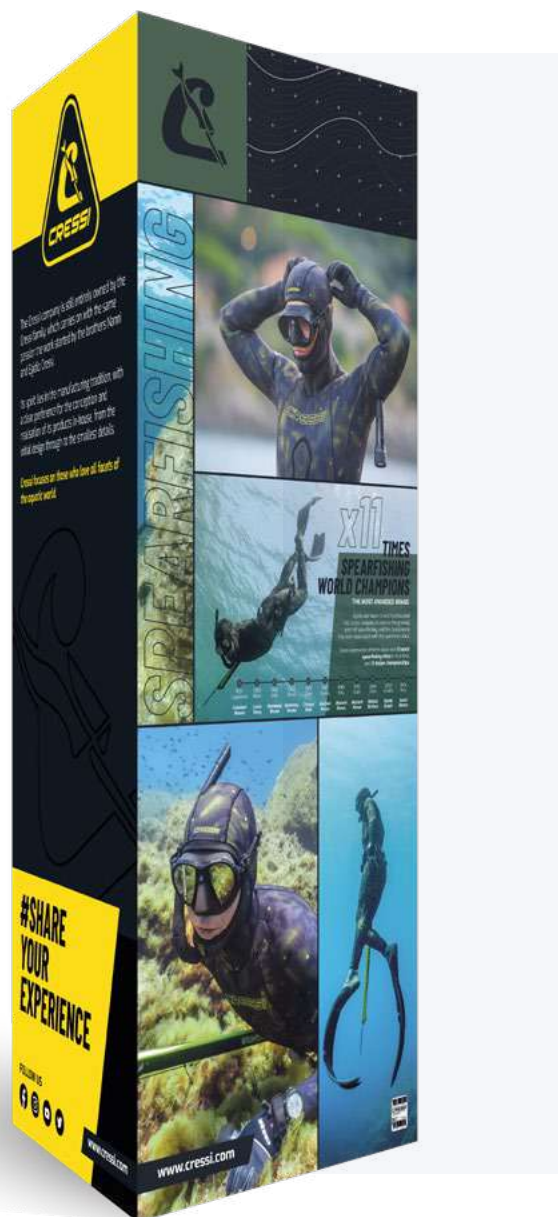

PRODUCT	CODE	DLR €	10%	SEASONAL ORDER 20%	RRP €
SPEARFISHING DISPLAY TOTEM	TOTEMSF01	53.74	48.37	42.99	-

# BANNERS AND FLAGS

## CRESSI DIVE CENTER

Cressi banners and flags are the ideal support for dive centers. Three different dimensions and shapes for every need.



**BANNER FLAG**  
350 X 60 CM



**RECTANGLE FLAG**  
150 X 90 CM

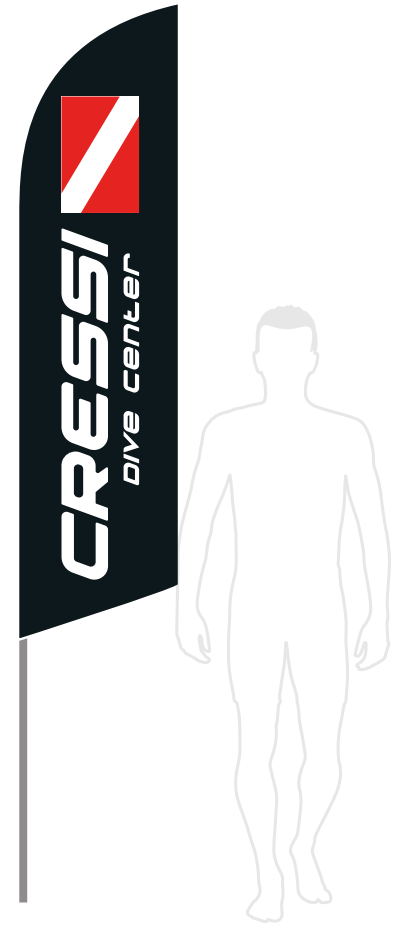

**WING FLAG**  
60 X 240 CM

POLE LENGTH: 340 CM

PRODUCT	CODE	DLR €	10%	SEASONAL ORDER 20%	RRP €
RECTANGLE FLAG CRESSI DIVE CENTER 150x90 cm	VABANDIVE01	8,74	7,87	6,99	-
BANNER FLAG CRESSI DIVE CENTER 350x60 cm	VABANDIVE02	11,88	10,69	9,50	-
WING FLAG CRESSI DIVE CENTER 60x240 cm	VABANDIVE03	14,99	13,49	11,99	-





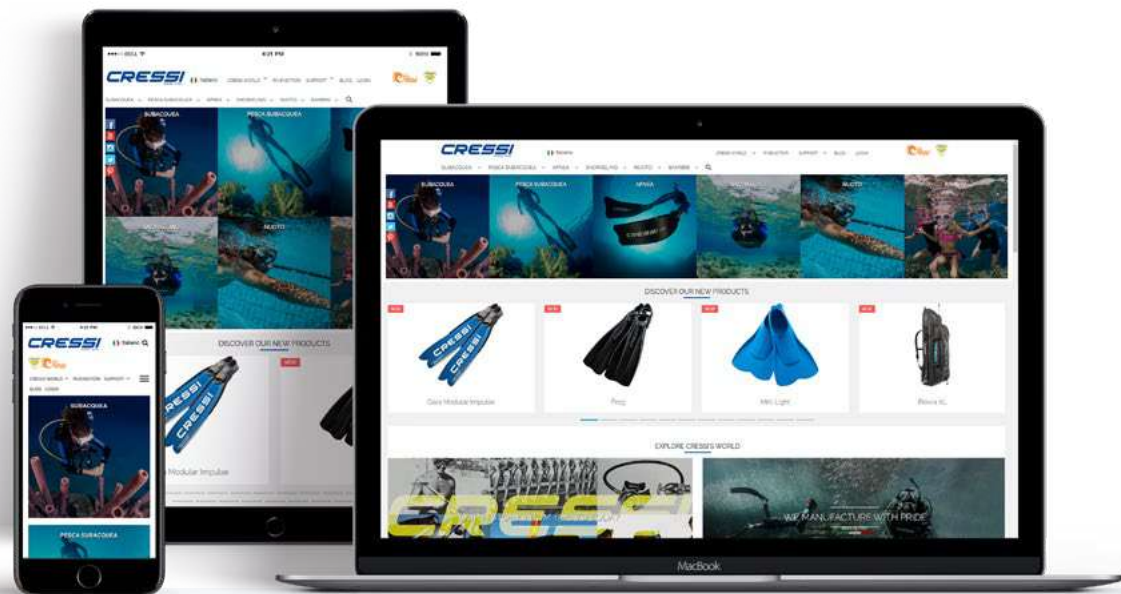
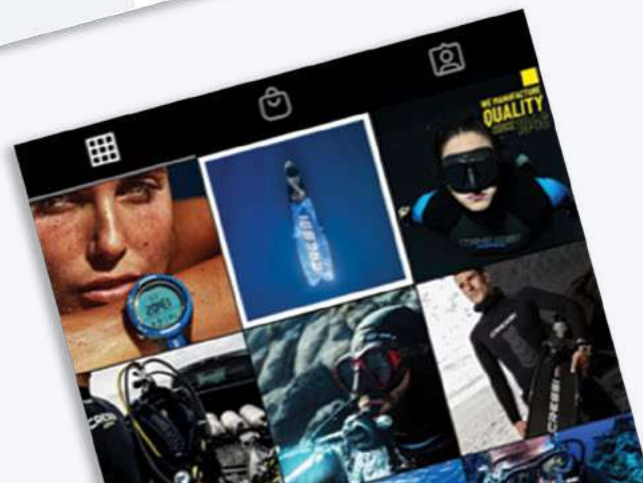
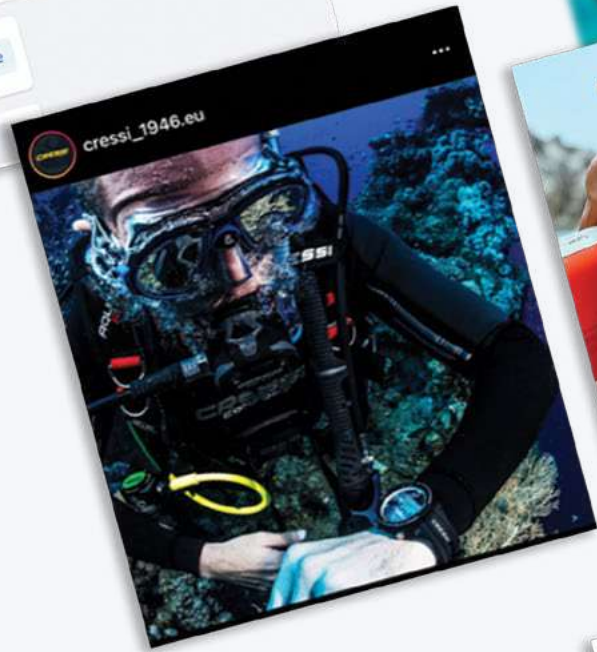
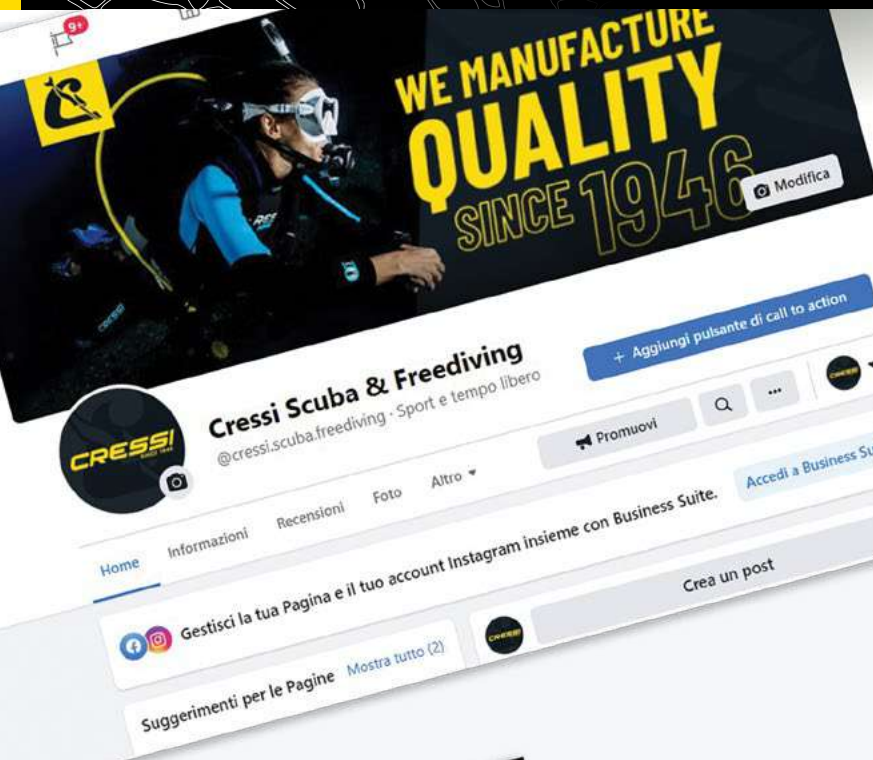

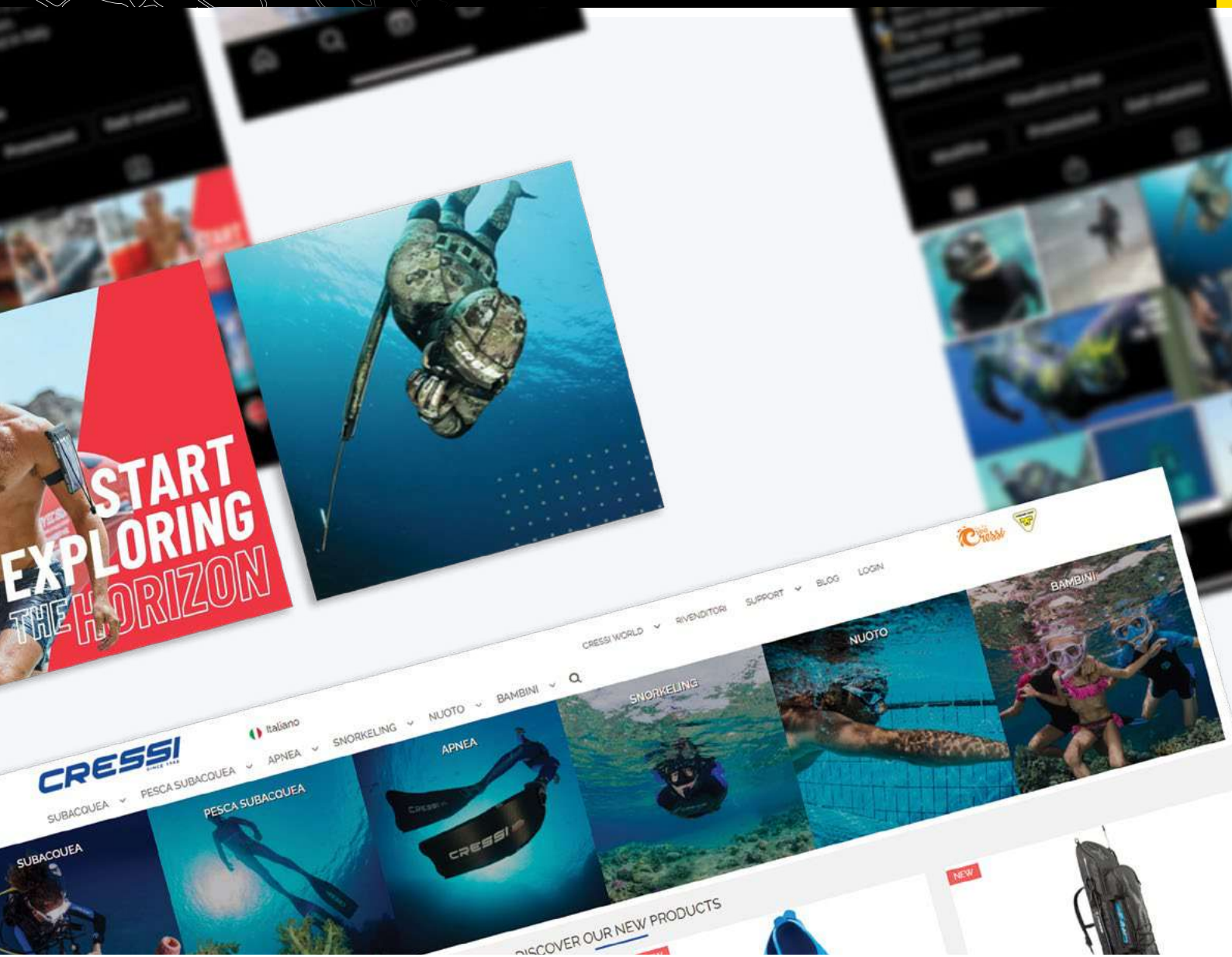

# #SHARE YOUR EXPERIENCE

FOLLOW US



## Official Website

[www.cressi.com](http://www.cressi.com)

## Official Social Media

### Facebook

Cressigear  
 Cressi.scuba.freediving  
 Cressi.spearfishing  
 Cressi.hydrosports

### Instagram

Cressi 1946  
 Cressi Scuba & Freediving  
 Cressi Spearfishing  
 Cressi Hydrosports

### Youtube

Cressi

### Twitter

CressiItaly

### TikTok

Cressi 1946











**CRESSI**

GARA MODULAR  
SPRINT

**CRESSI**

GARA MODULAR  
SPRINT

**CRESSI**

**FROM  
GENOVA**





# 2023

COLLECTION

A project by Cressi Design Center  
Photo by Marcello Pastonesi, Studio Nicama, Rossella Murgia, Amedeo Picasso  
Thanks to: Bagni Medusa, Genova Nervi



# CRESSI BUYER'S GUIDE

[www.cressi.com](http://www.cressi.com)



**Cressi Sub S.p.A.**

**Headquarters:**

Via G. Adamoli, 501  
16165 Genova, Italy

© Cressi Sub S.p.A.. All rights reserved. Reproduction, scanning, transmittal or storage, by any means, of the images in this catalog, whole or in part, is prohibited without the prior written permission of Cressi Sub S.p.A.

EAN  
8 022983 221090

**CRESSI**  
BUYER'S GUIDE CATALOGUE EN € 2023

SKU: VPCABGENE23  
MADE IN ITALY      SREF: 600001

UPCA  
1 94482 02108 7

# ICONIC DIVE GEAR SINCE 1946